

**LEGO**

# NEXO KNIGHTS



7 [LEGO.com/nexoknights](http://LEGO.com/nexoknights)

70321



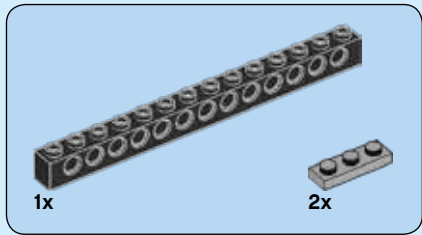
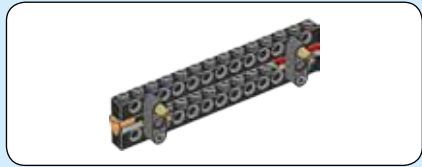
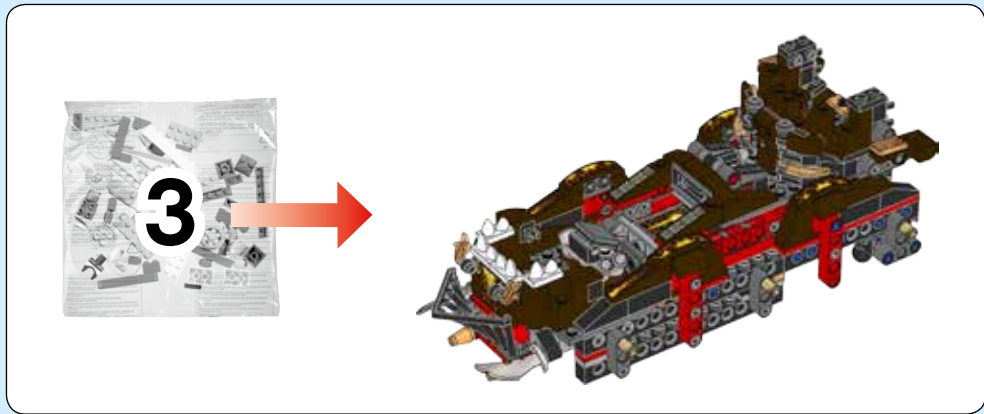

71

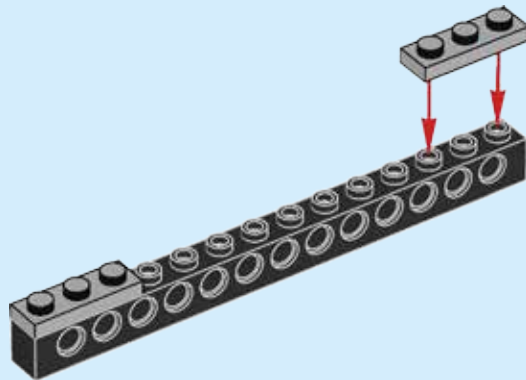



# 72

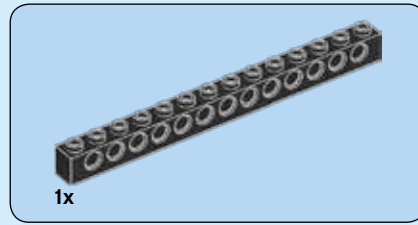
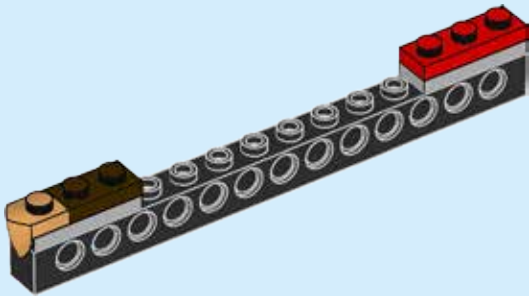

# 73

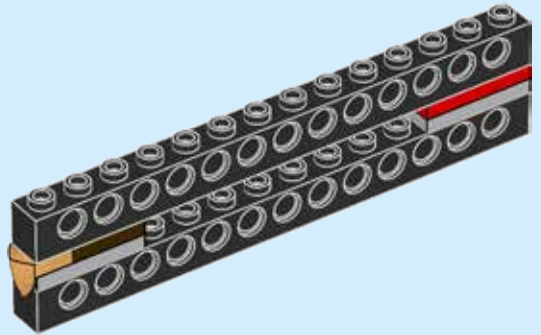

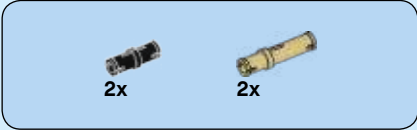

74

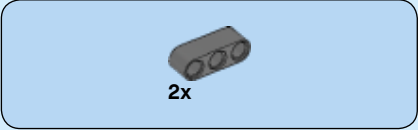
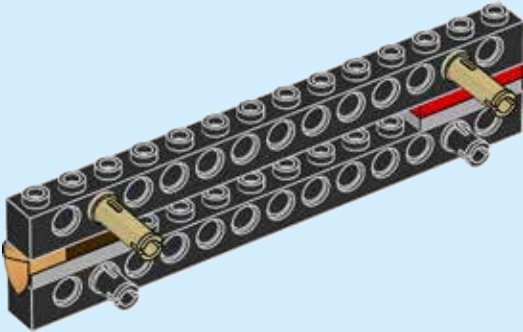

75

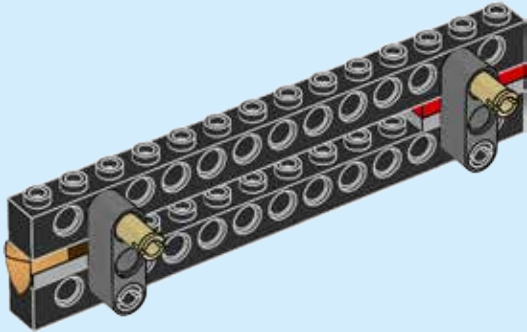

76

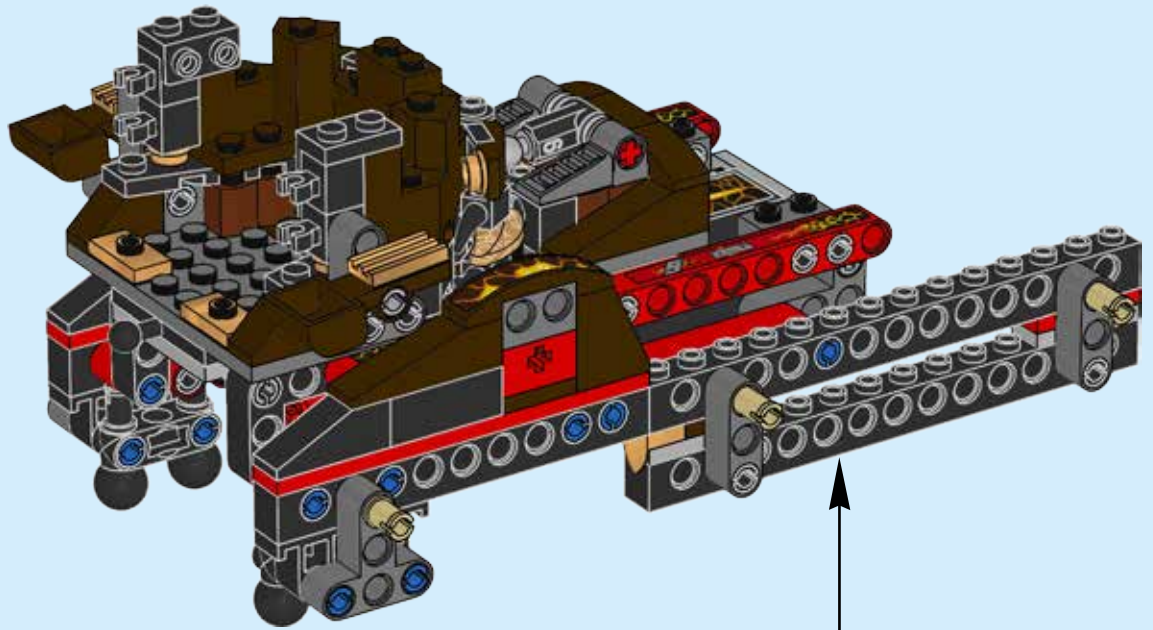

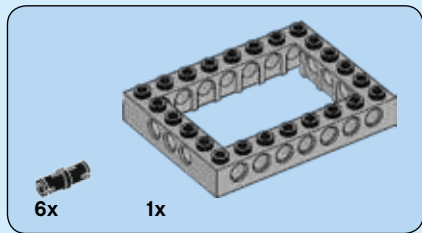

77

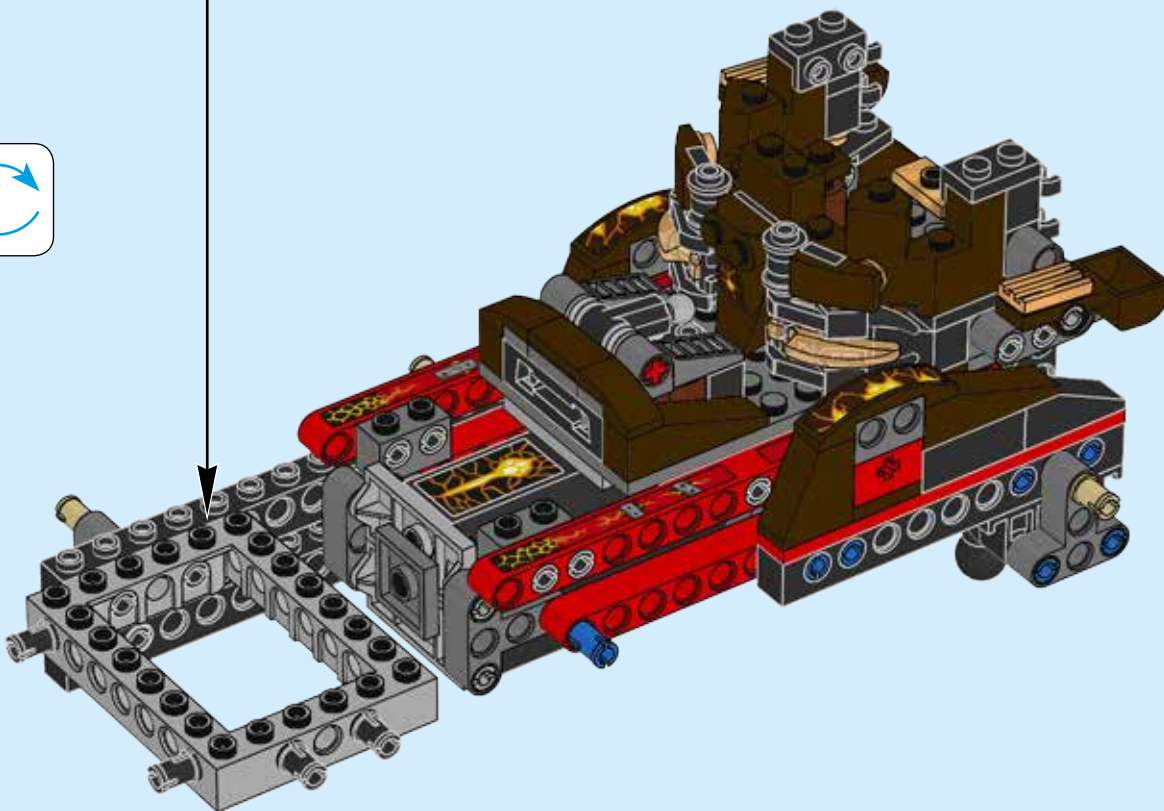
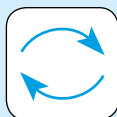
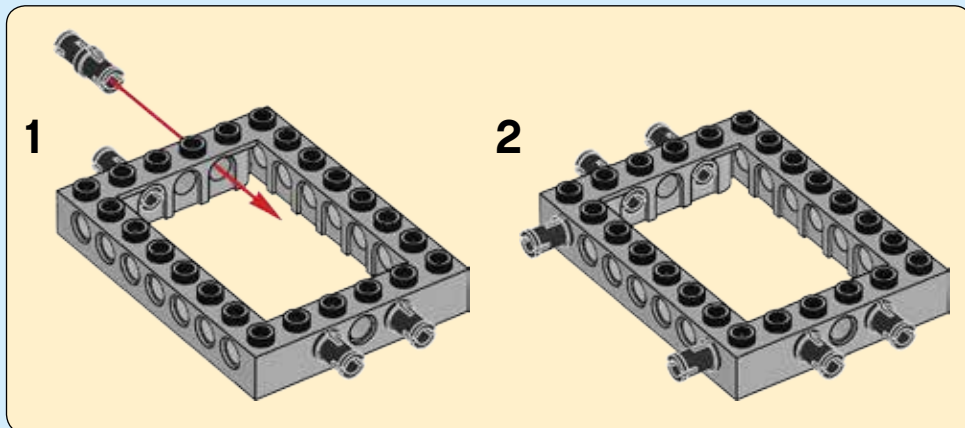

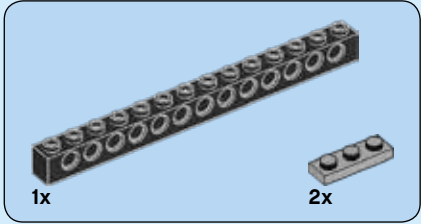
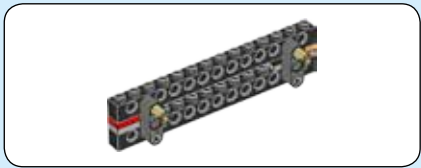

# 78

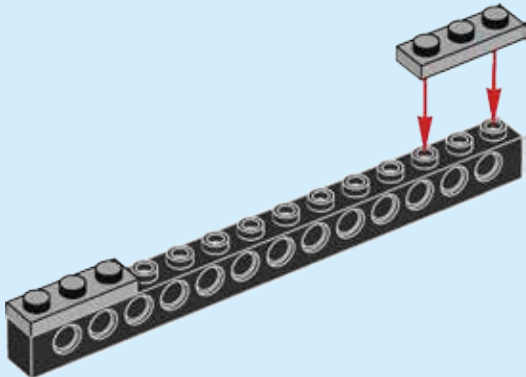

# 79

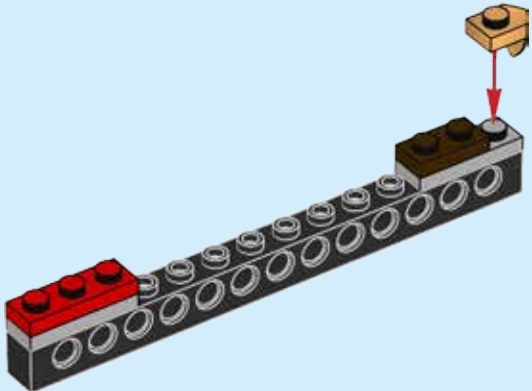

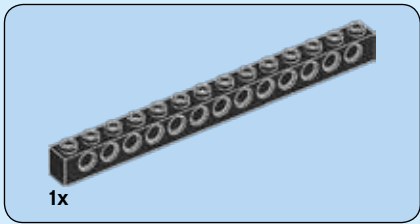

80

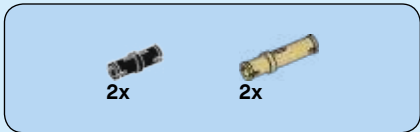
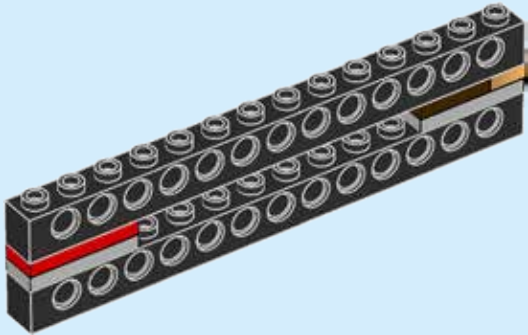

81

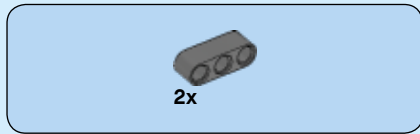
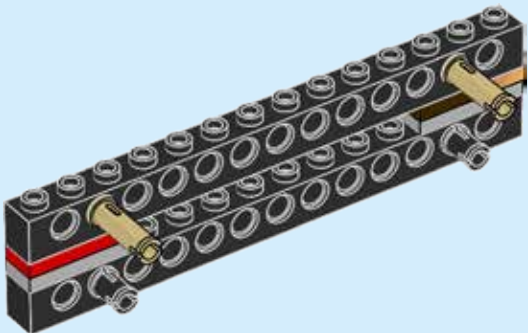

82

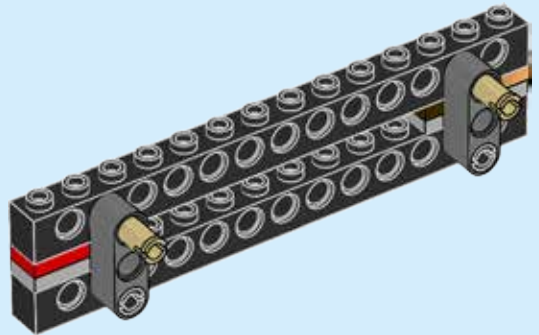



83

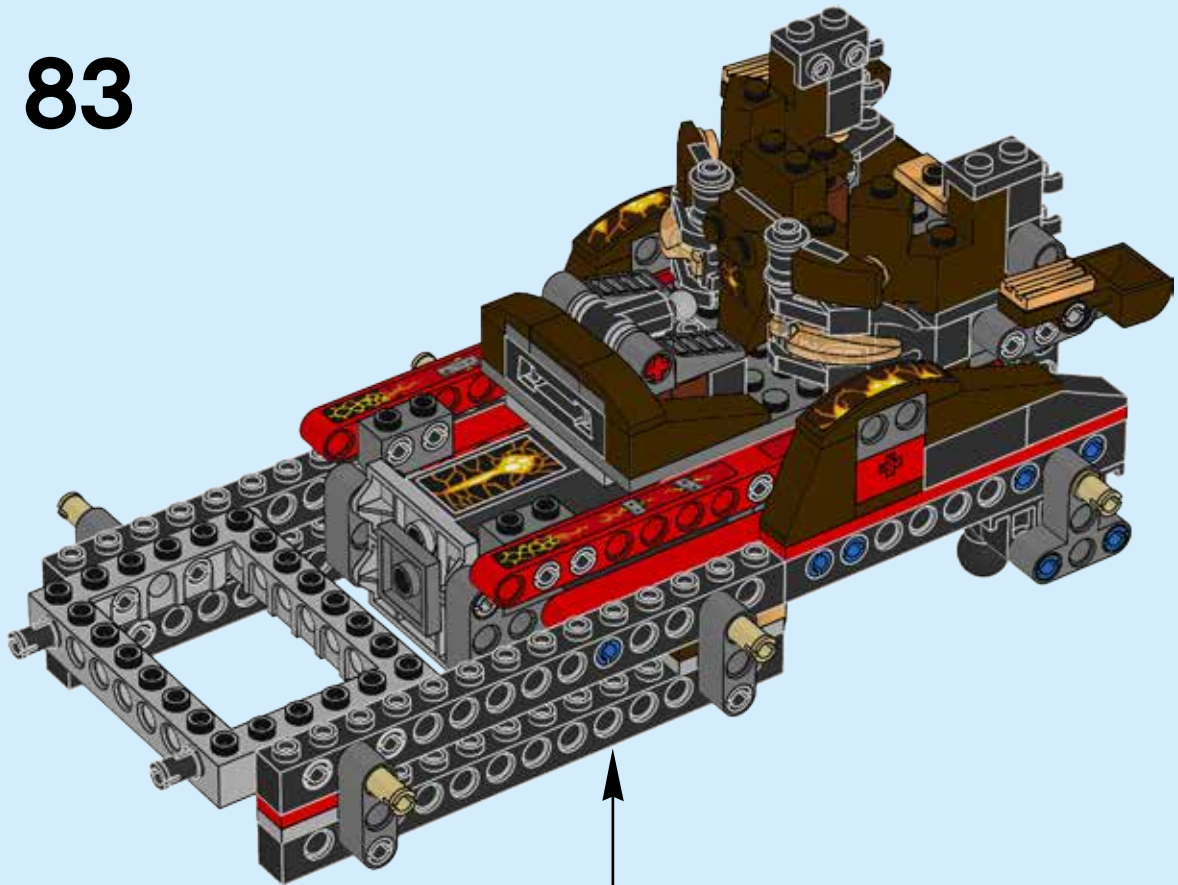

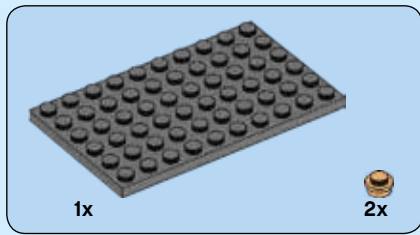

84

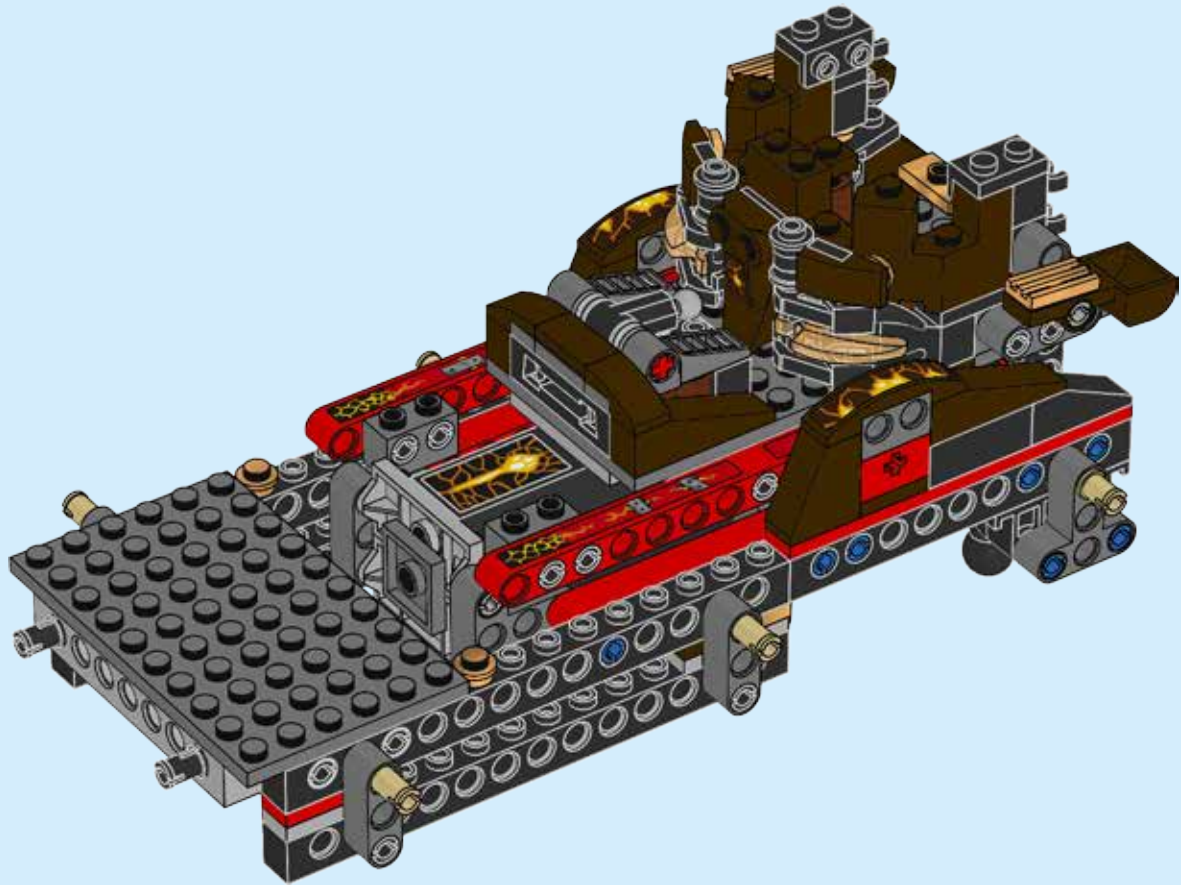



# 85

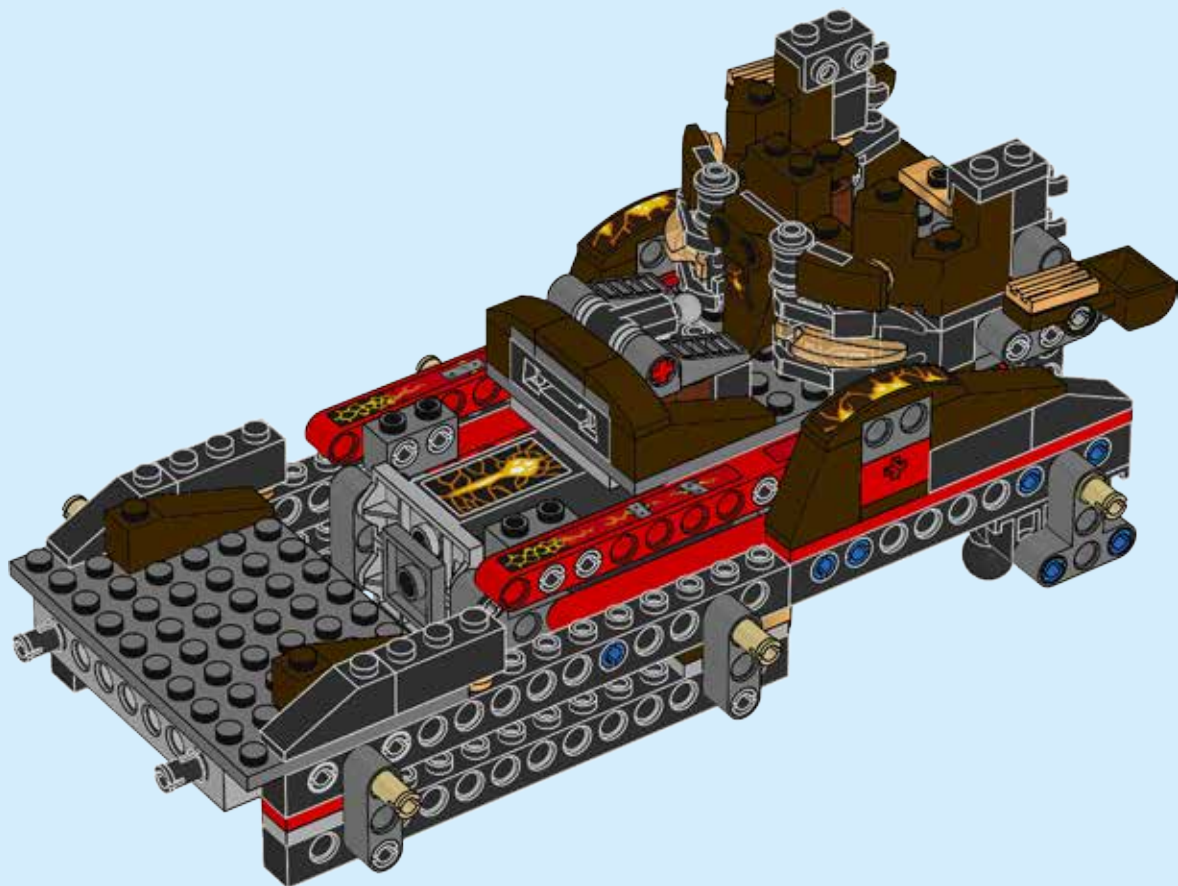

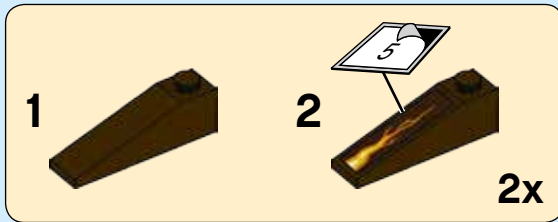

86

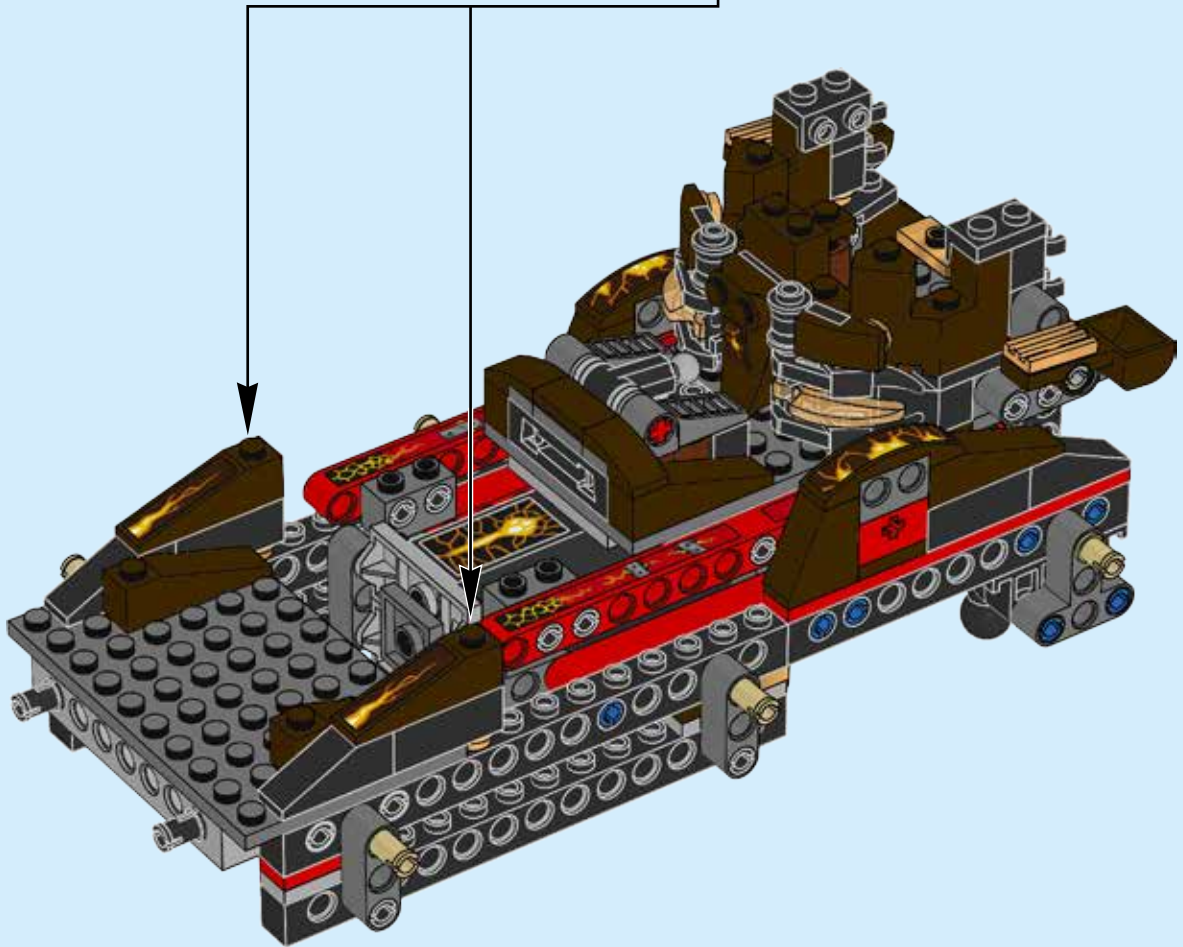

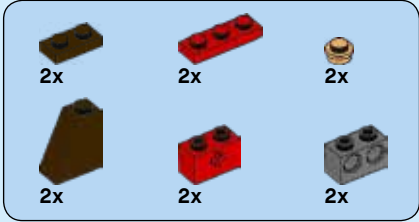

# 87

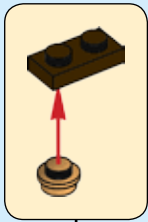
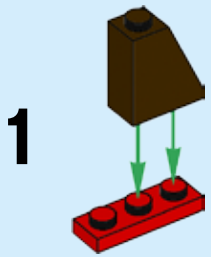

2

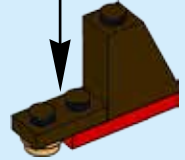

3



4



2x

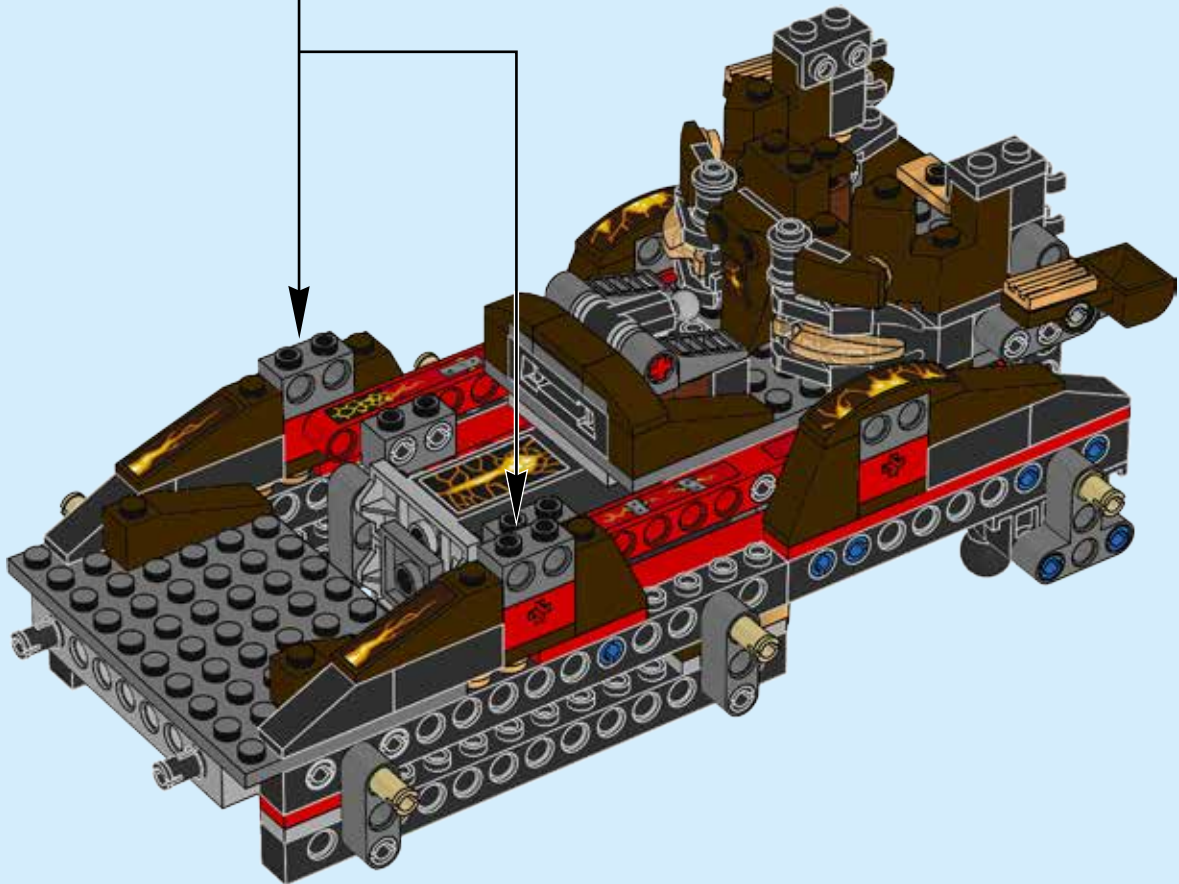



# 88

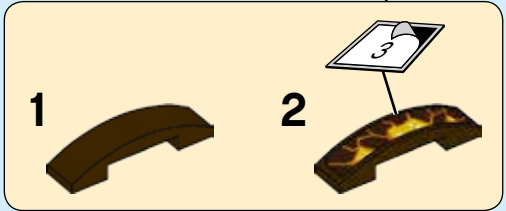
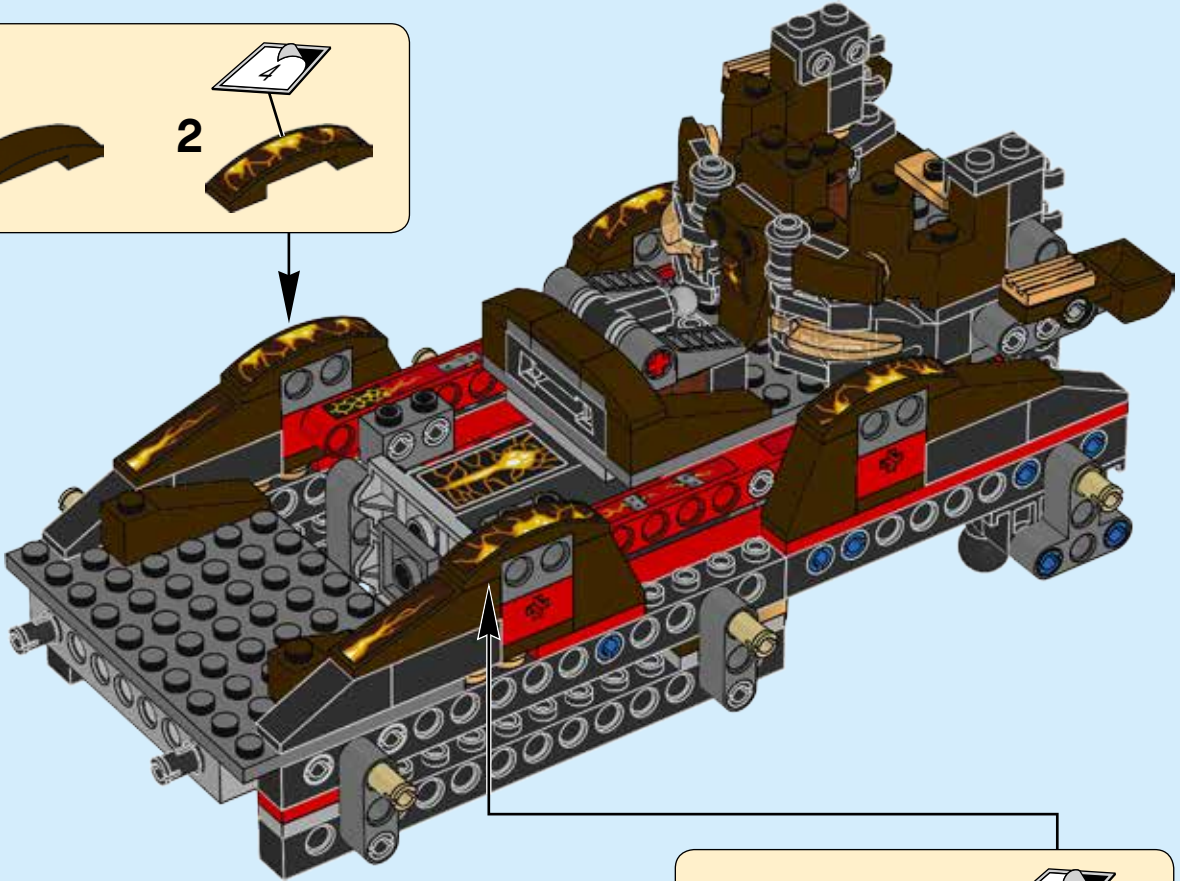



2x

# 89

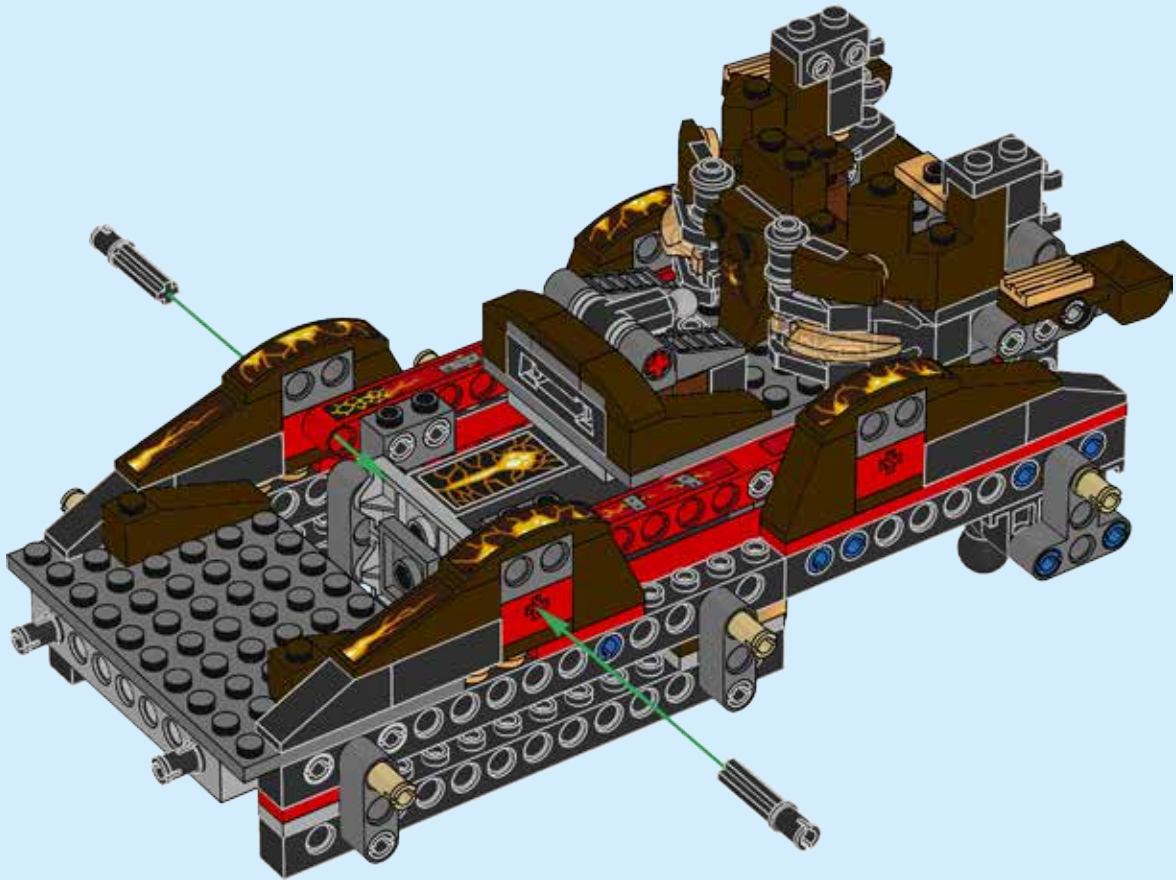



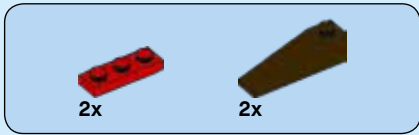

90

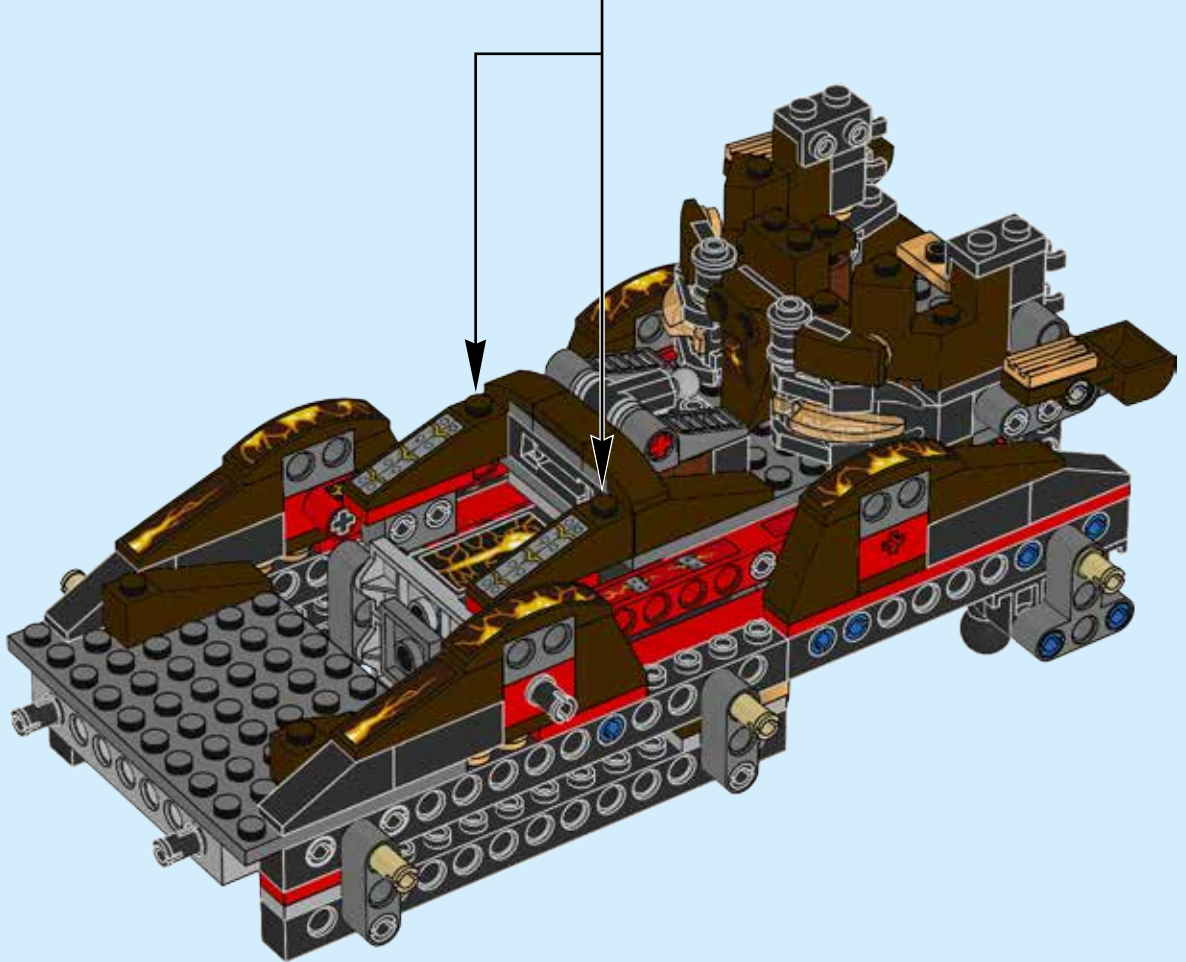
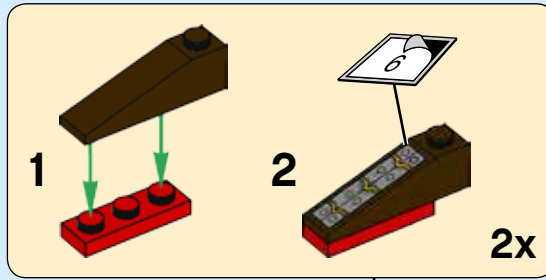



4x

# 91

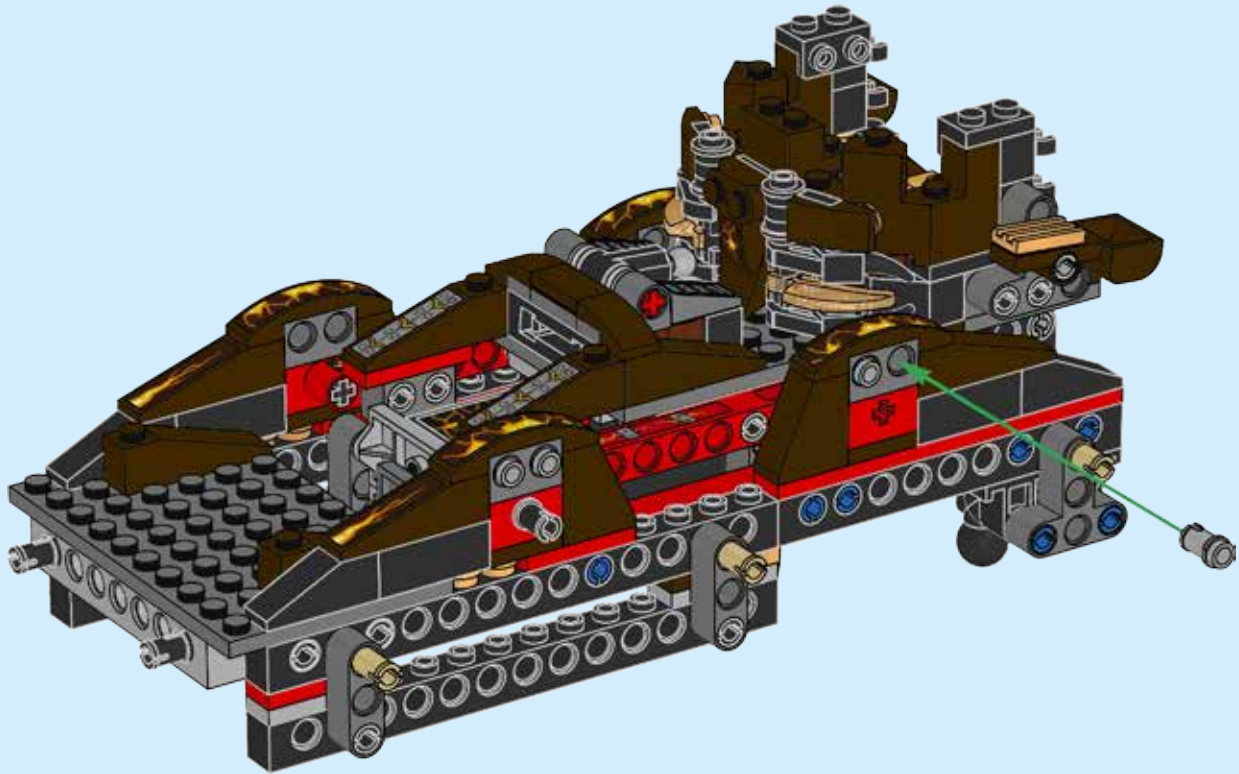



3x



1x

# 92

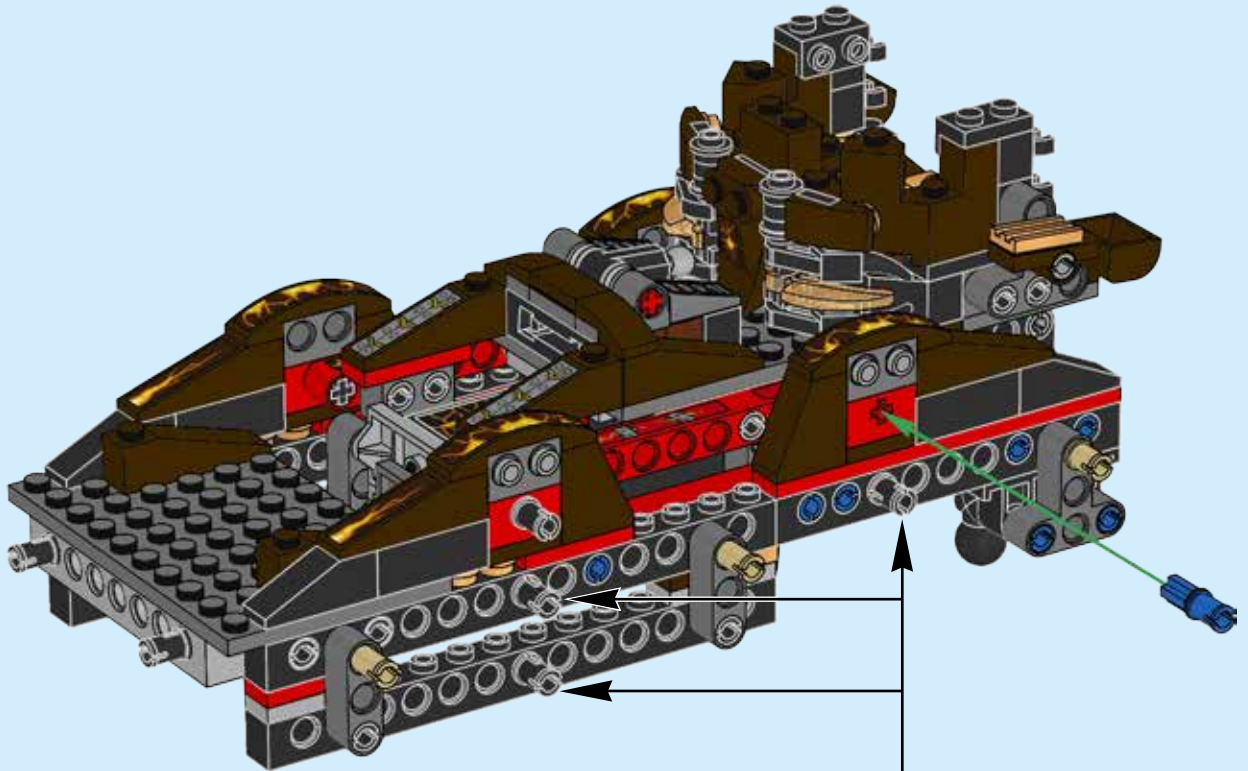

3x

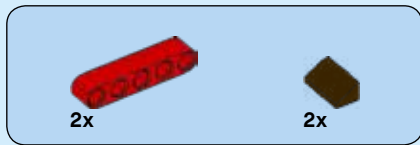

93

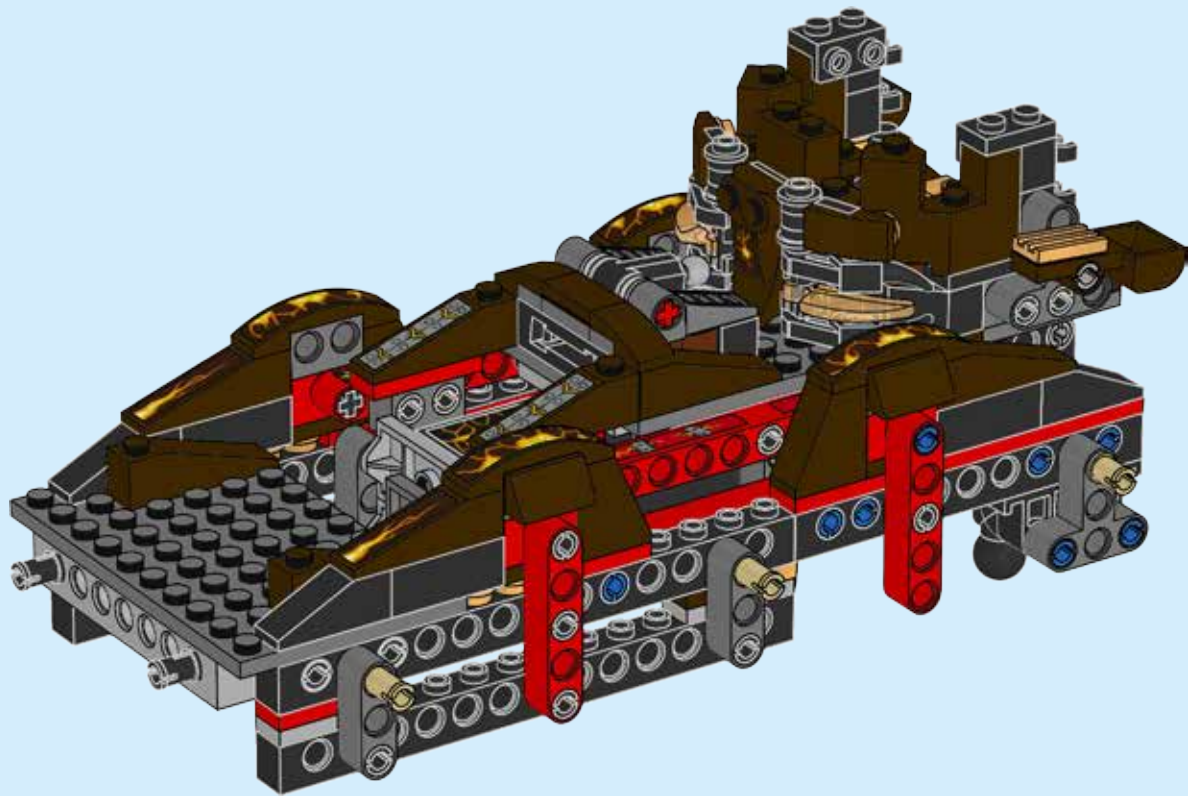



# 94

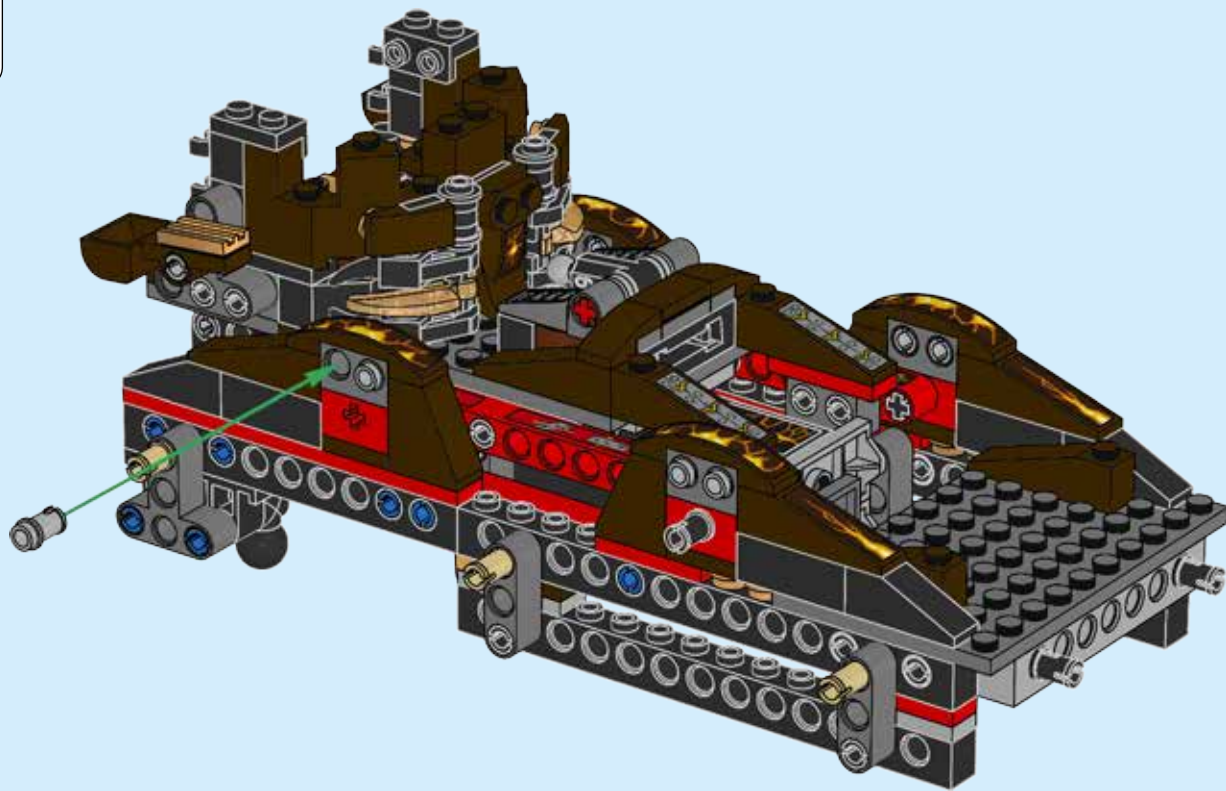
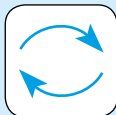



3x



1x

# 95

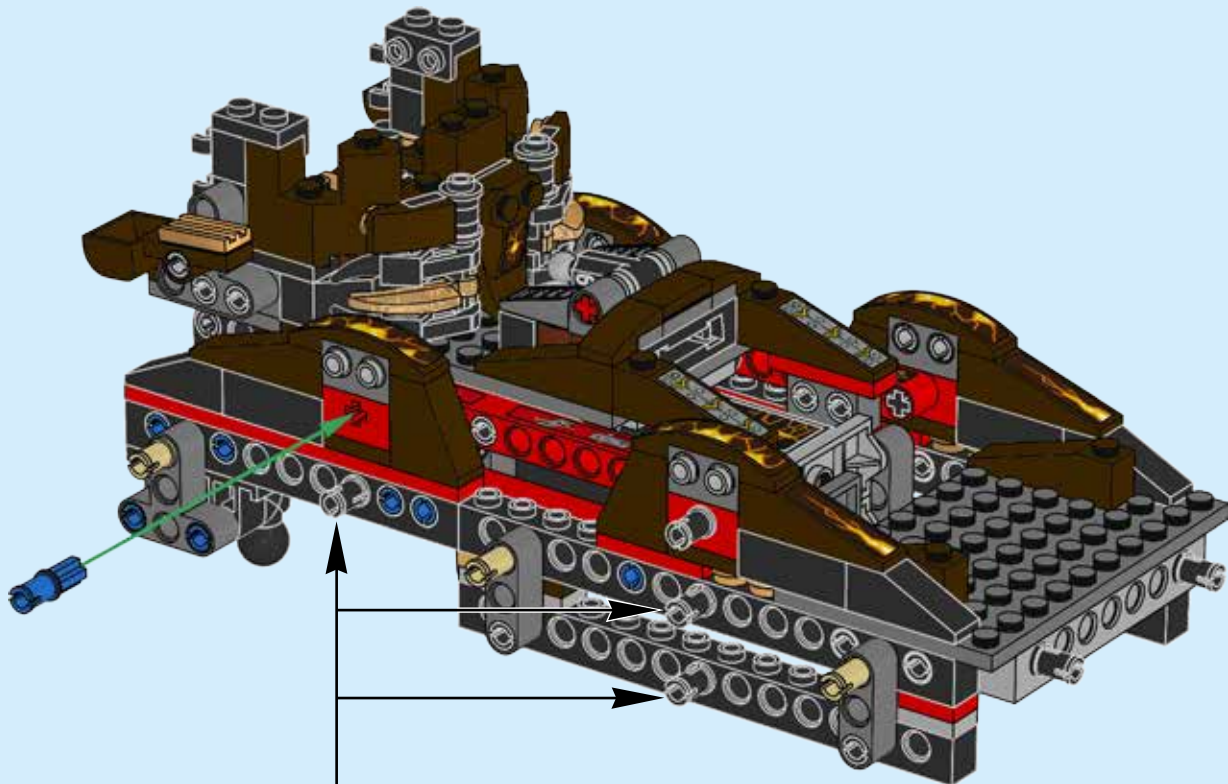

3x

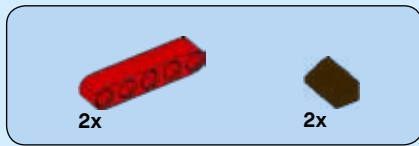

96

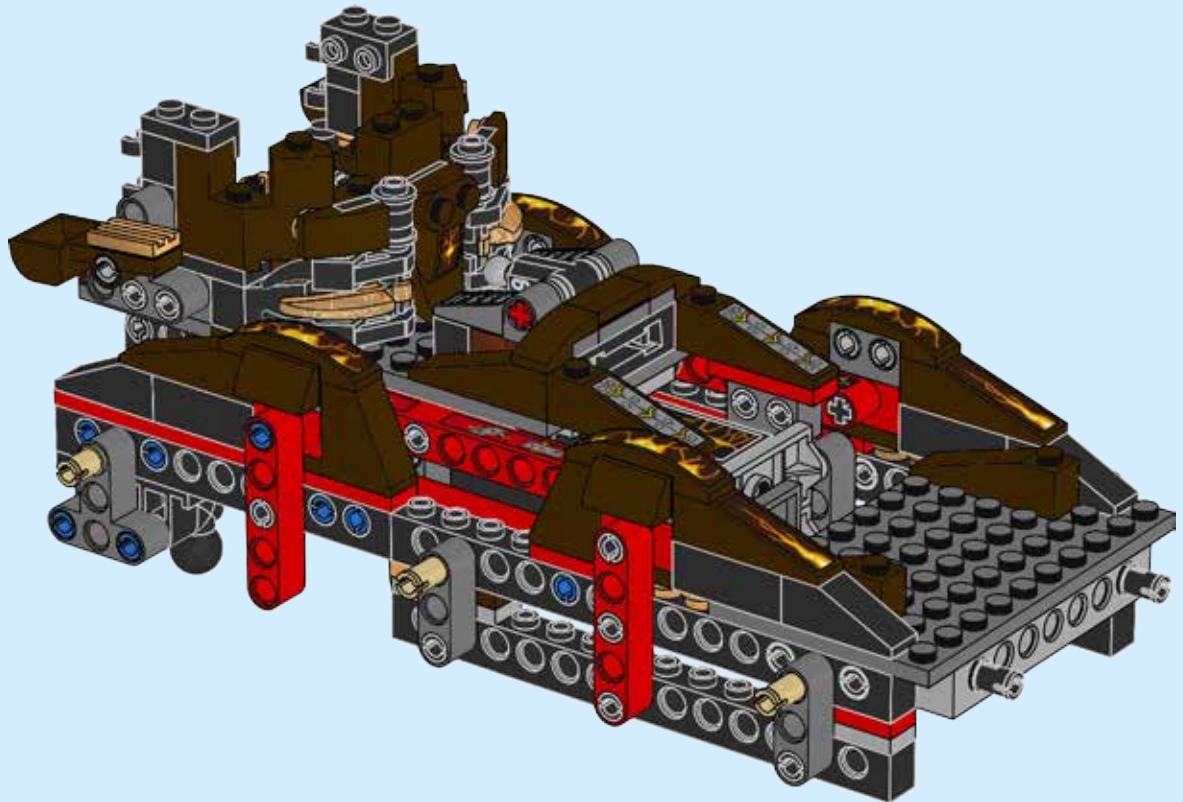

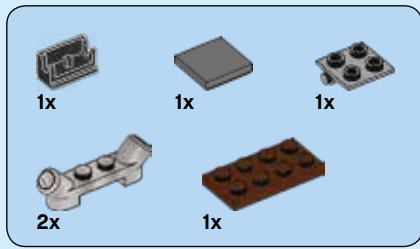

# 97

1



2

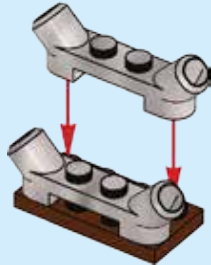

3

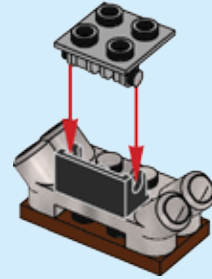

4

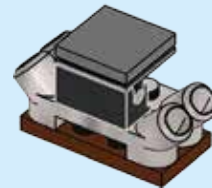



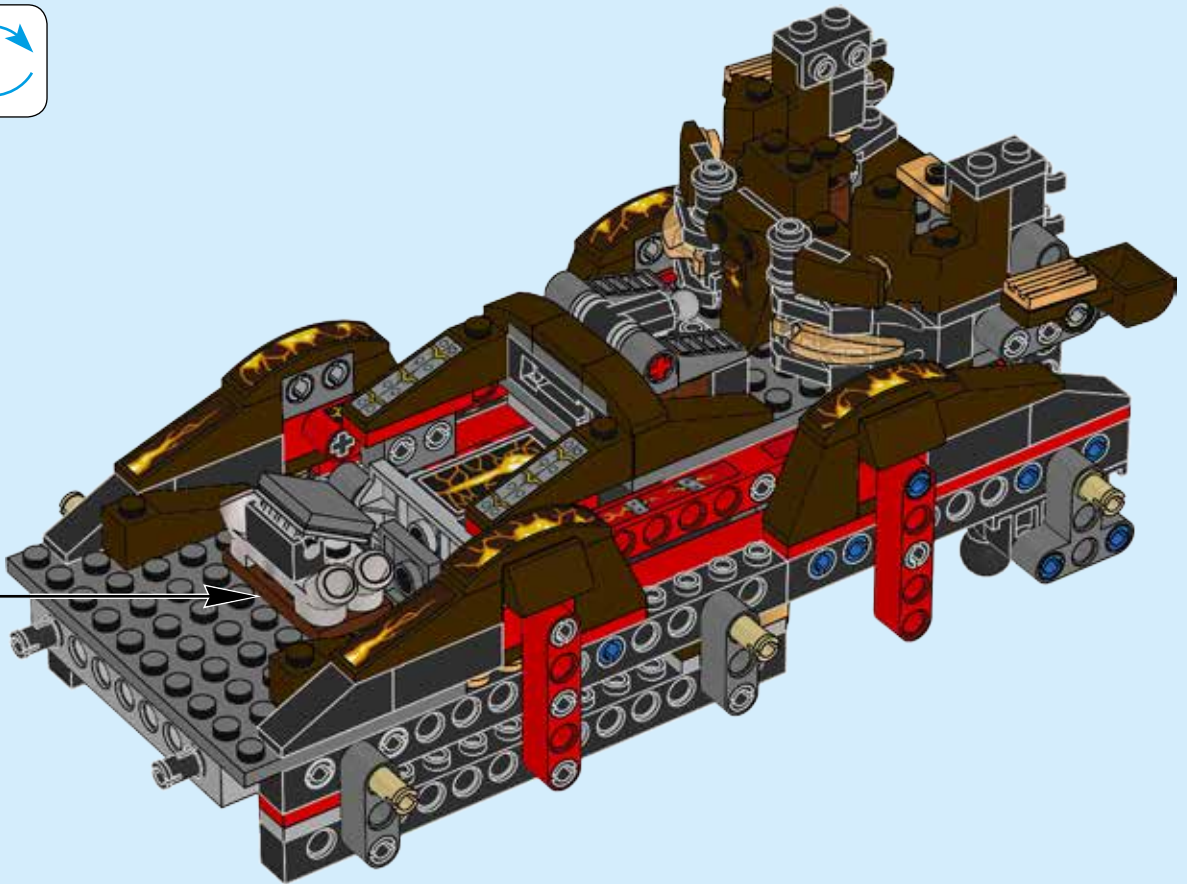
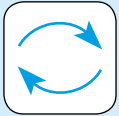



# 98

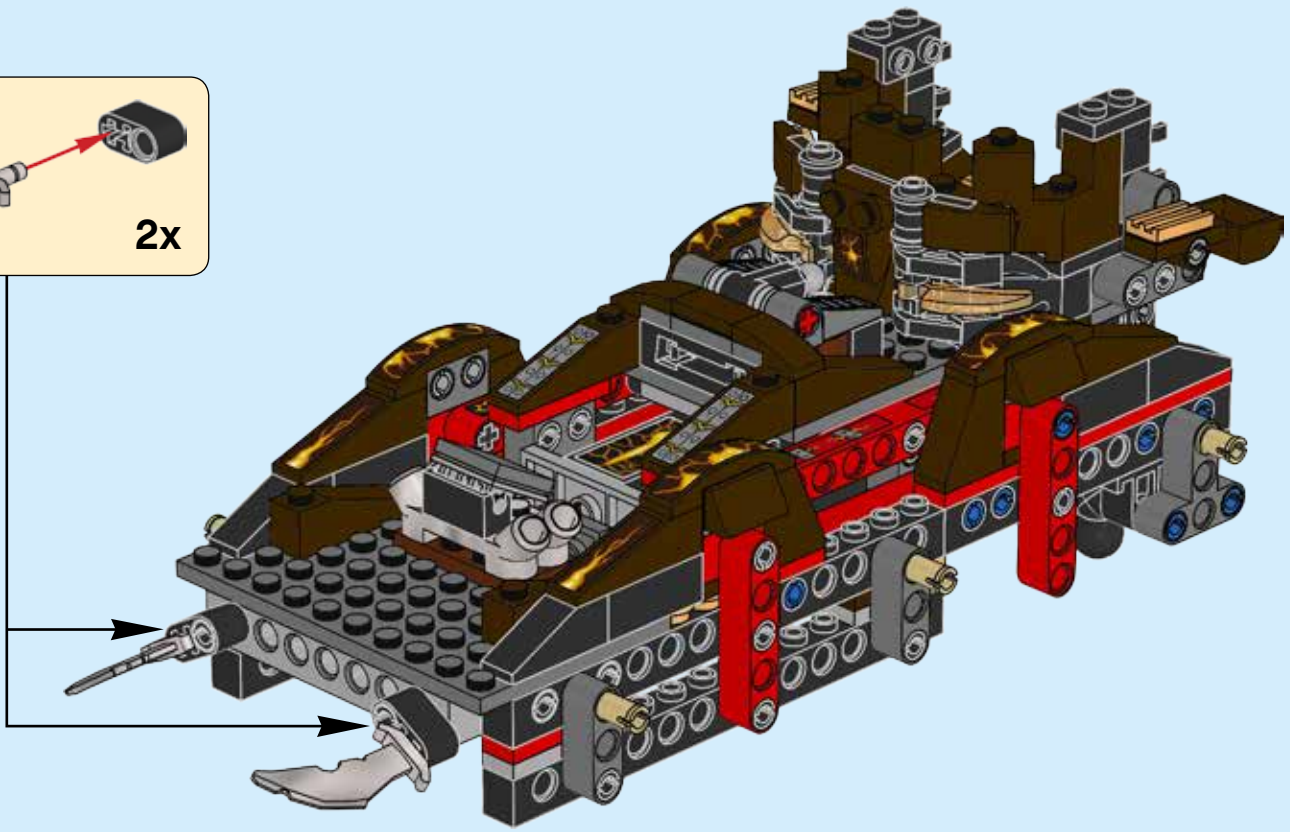
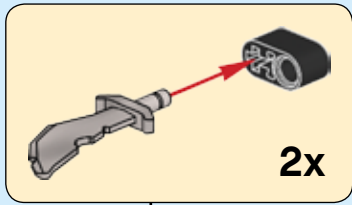

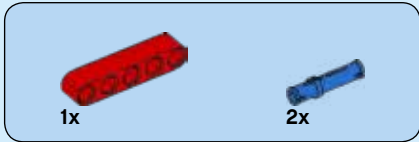

99

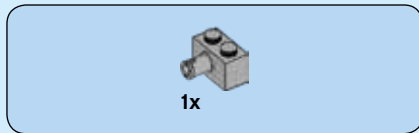
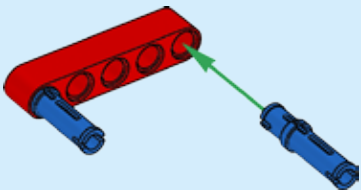

100

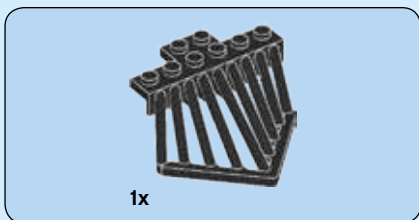
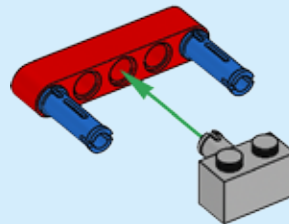

101

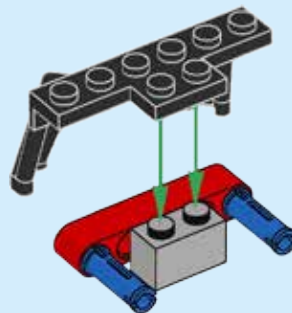



3x

# 102

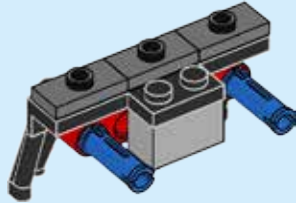

1x

# 103

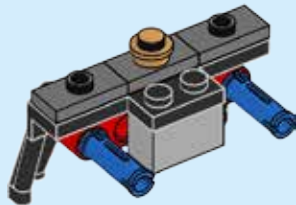

2x

# 104

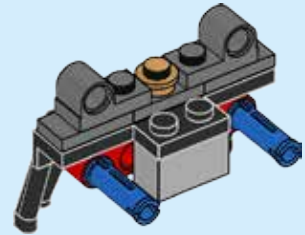

1x

# 105

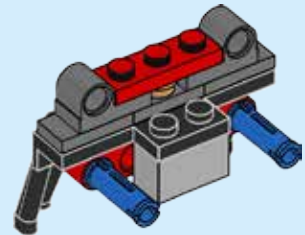



2x



2x

# 106

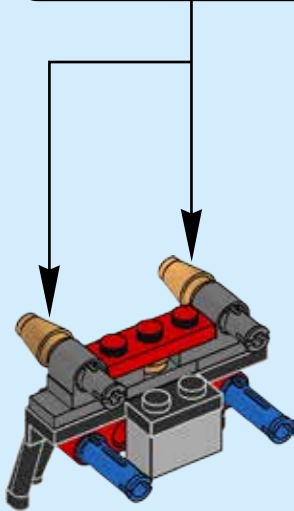
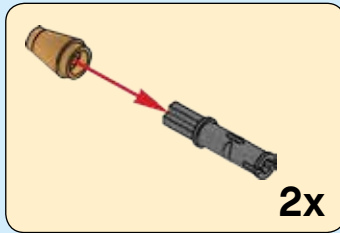

2x

# 107

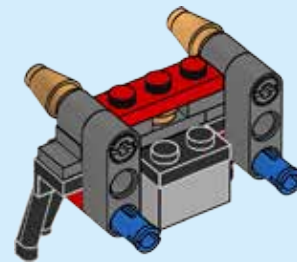

108

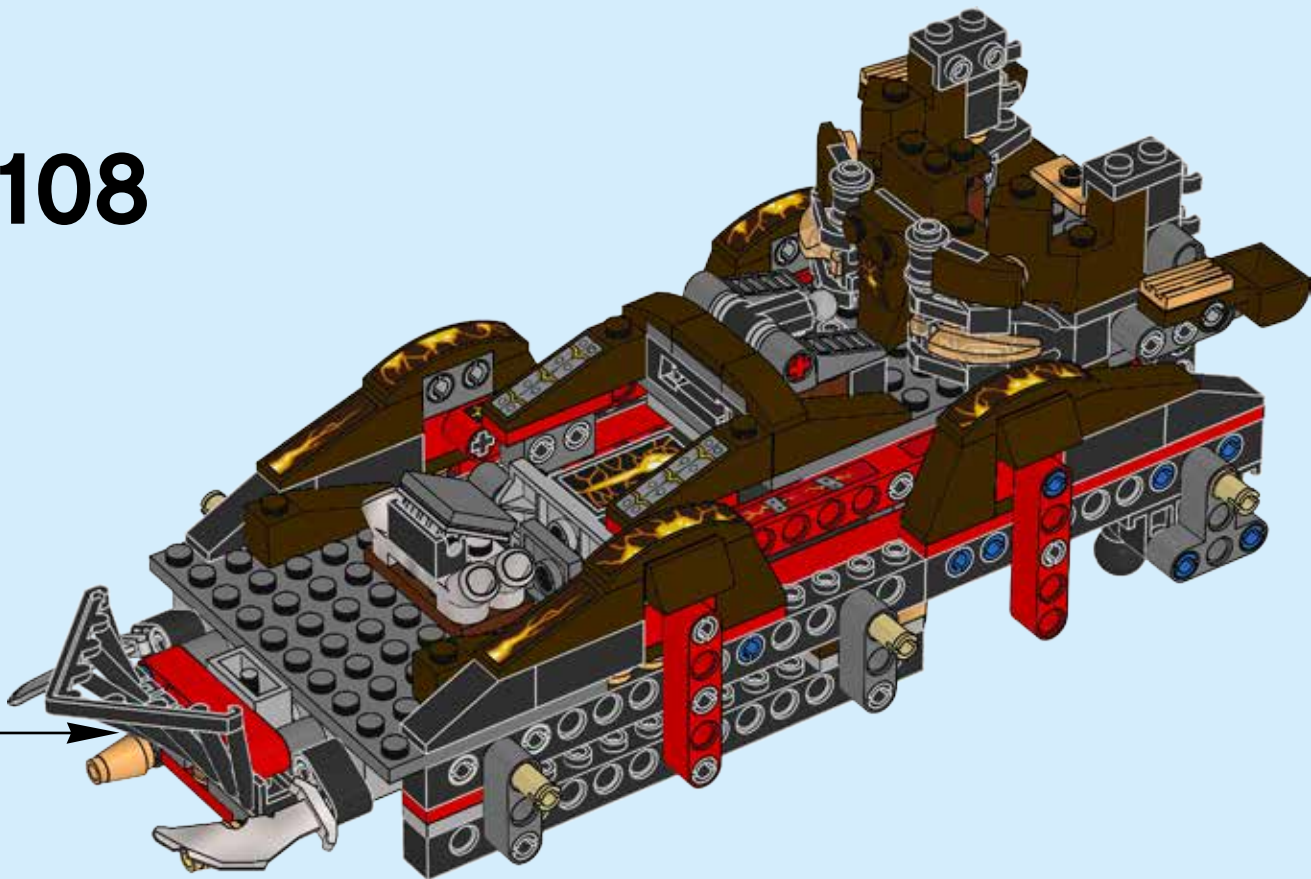

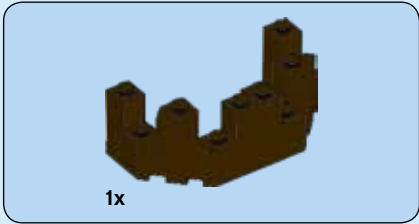

**109**

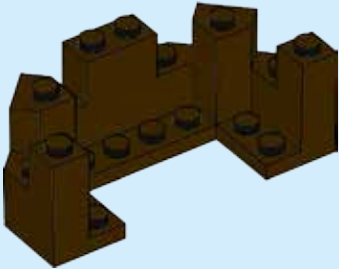

**110**

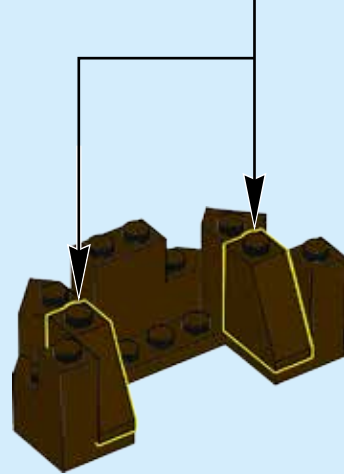

# 111

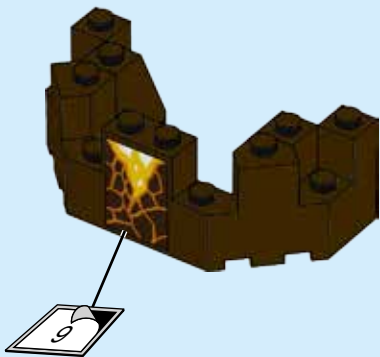
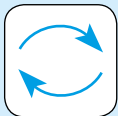

# 112

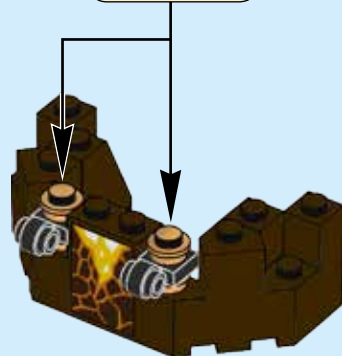
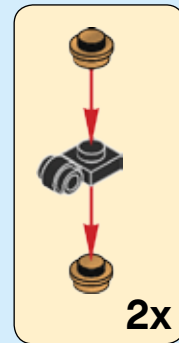





4x

# 113



2x

# 114



# 115

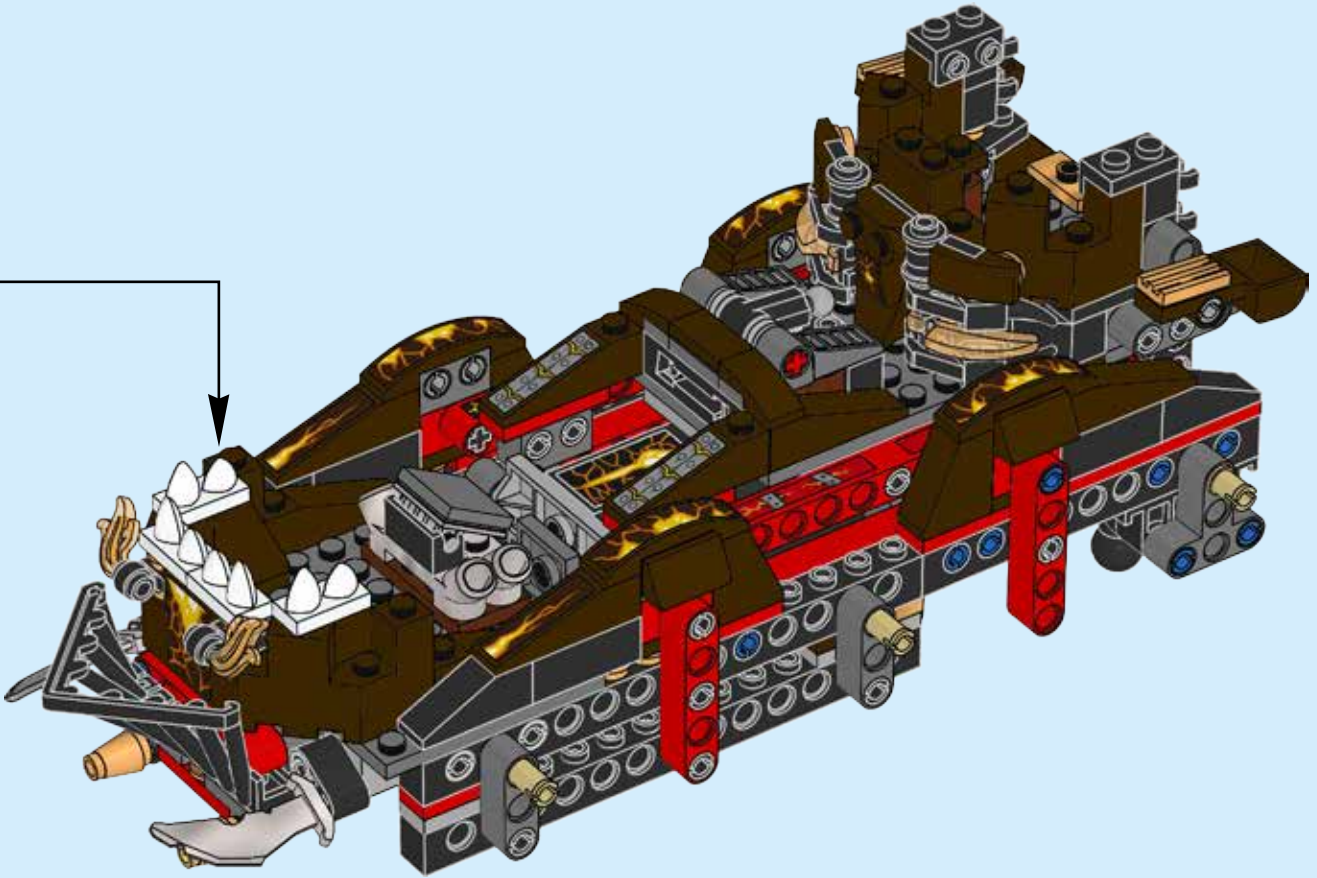



# 116



2x

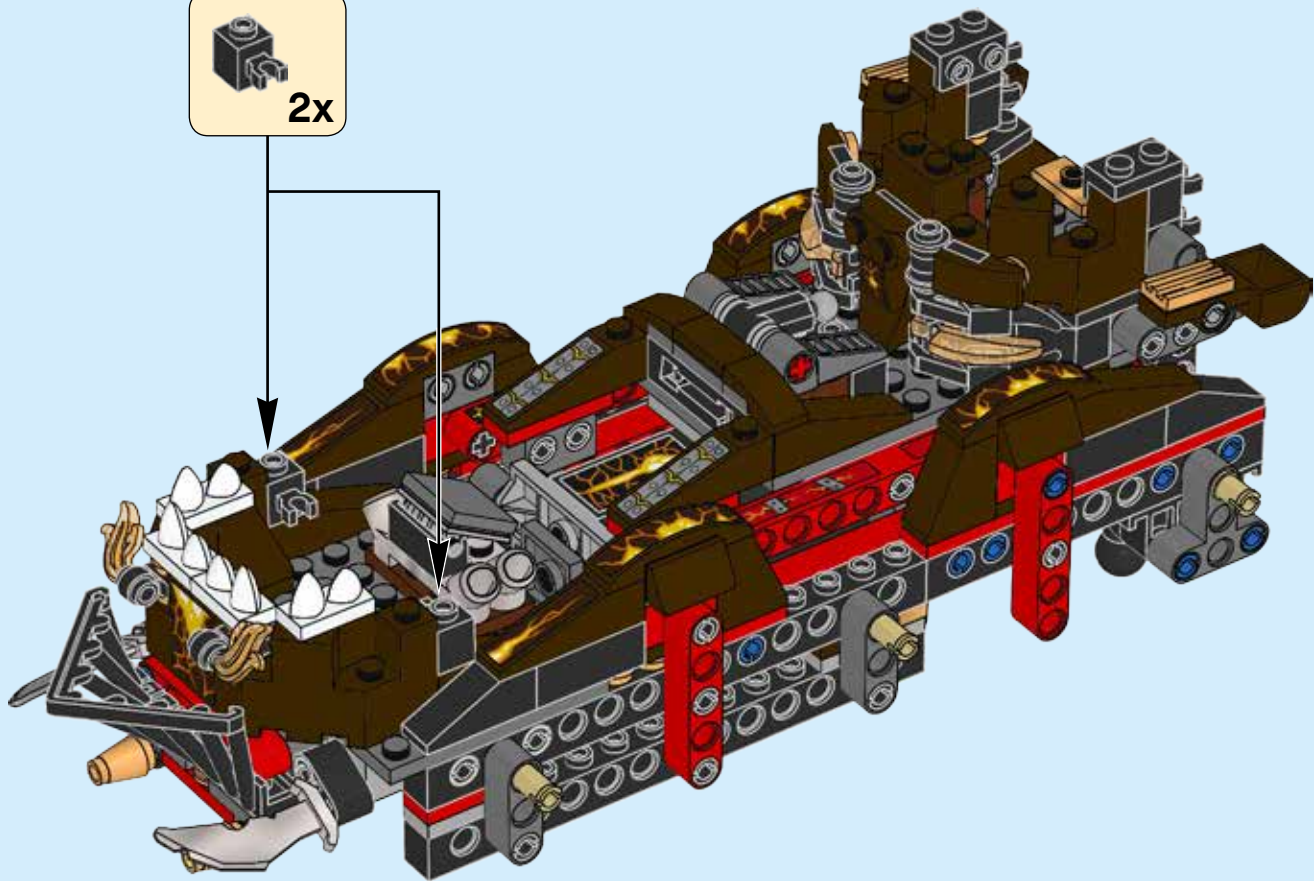



2x

# 117

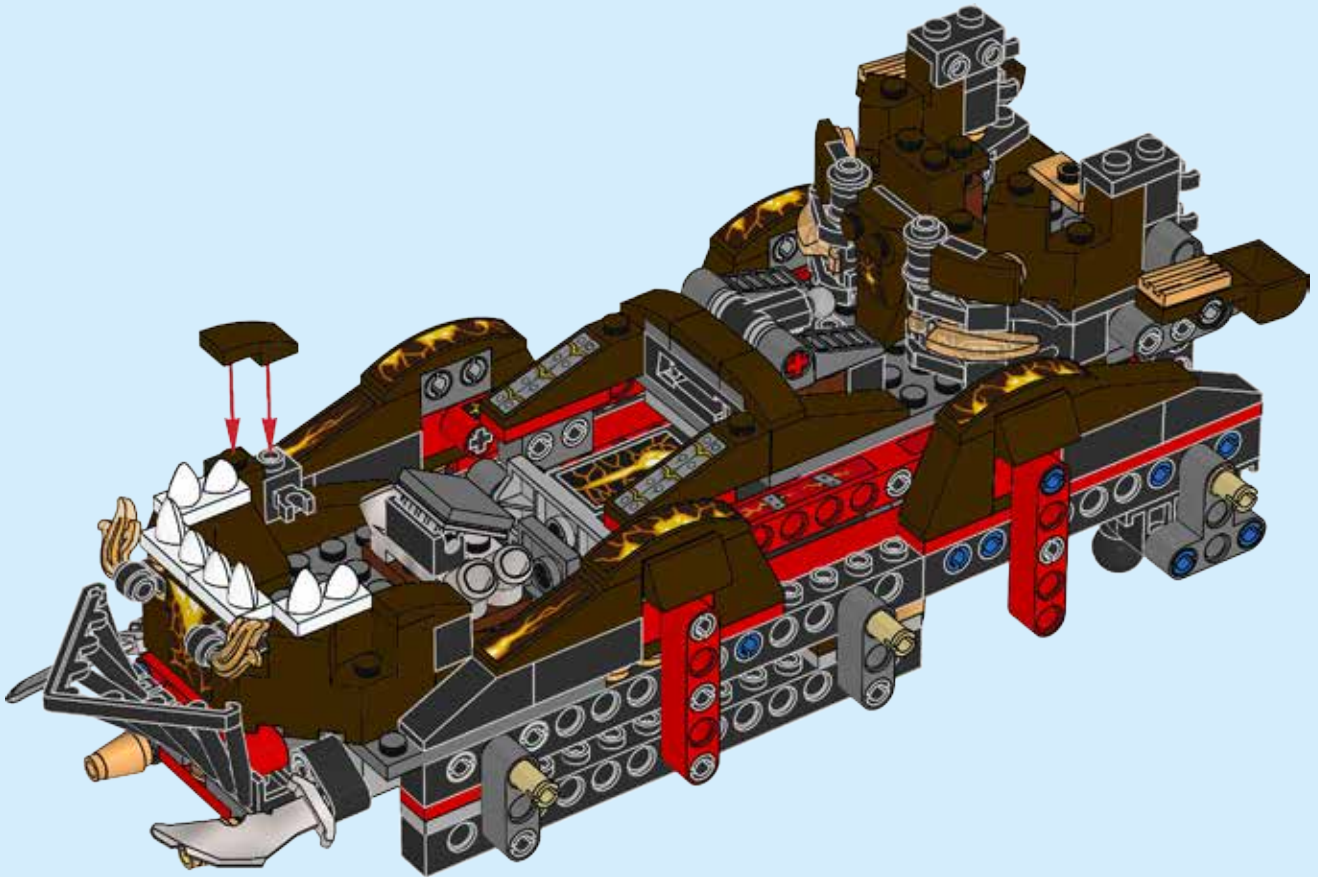



6x

+

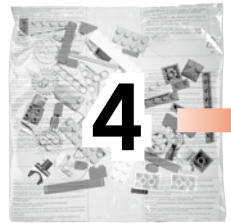

4

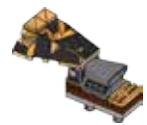

4x



1x



1x

# 118

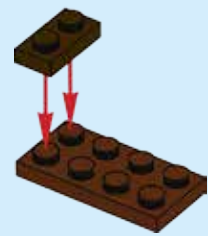

1x



1x



1x

# 119

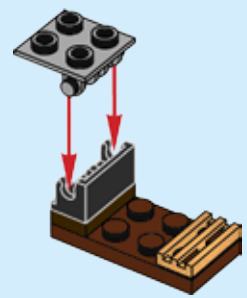



1x

# 120

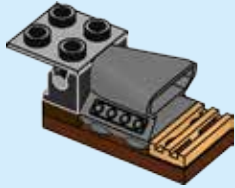

2x

# 121

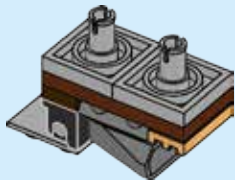
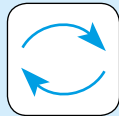

1x



2x



1x

# 122

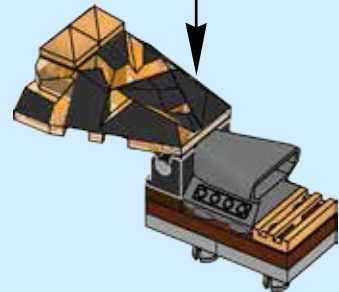
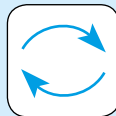
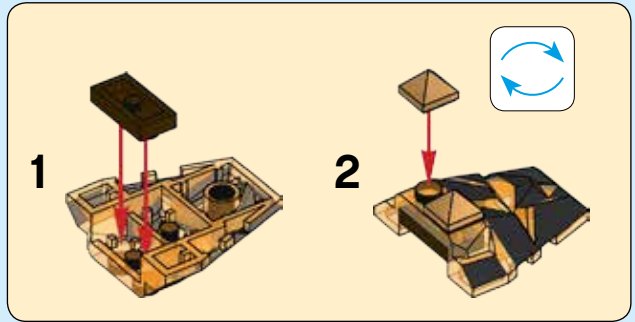

# 4x

# 123

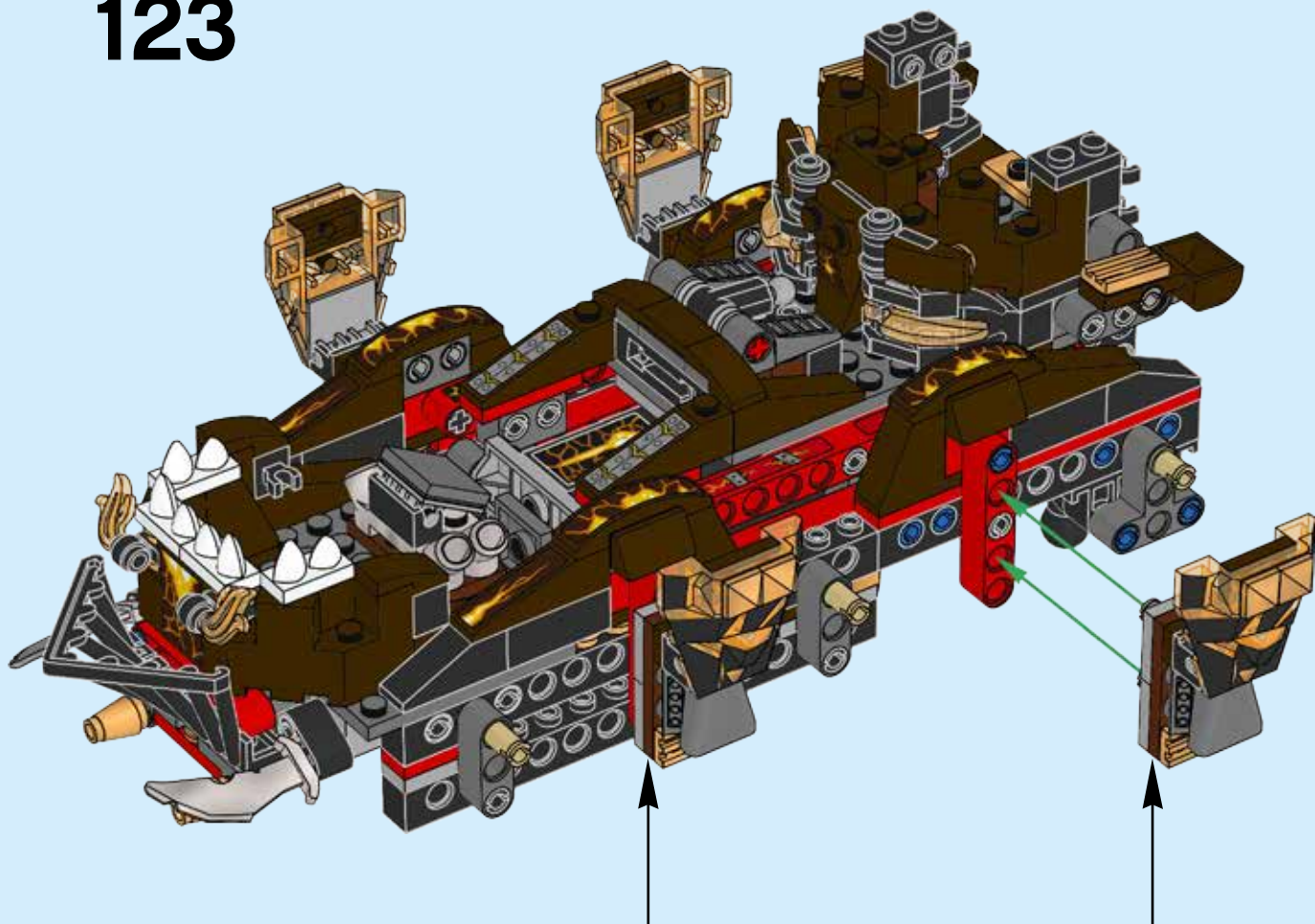

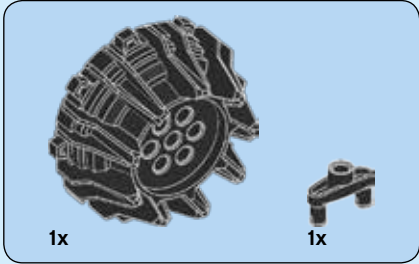

# 124

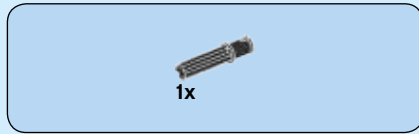
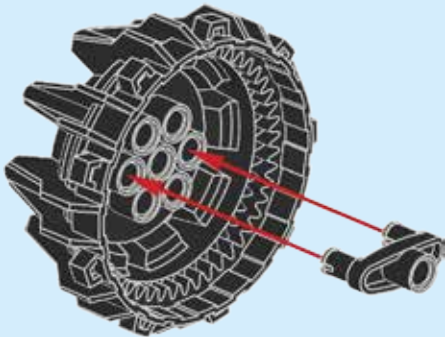

# 125

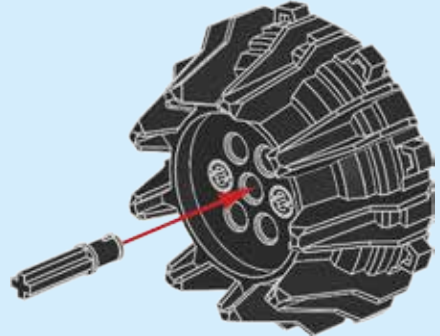
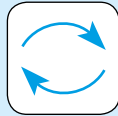

# 126







127

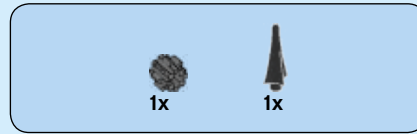
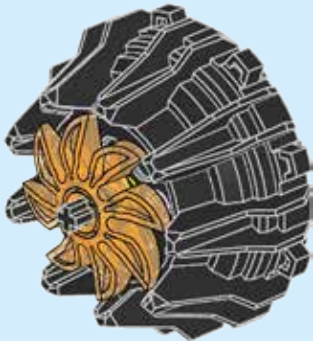

128

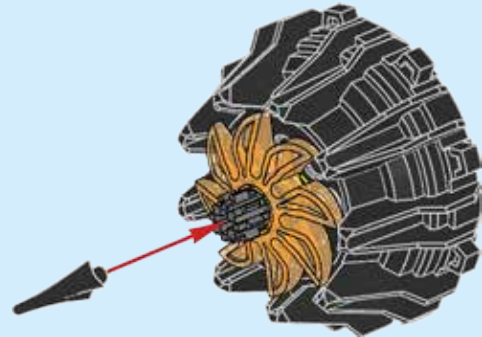

3x

# 129

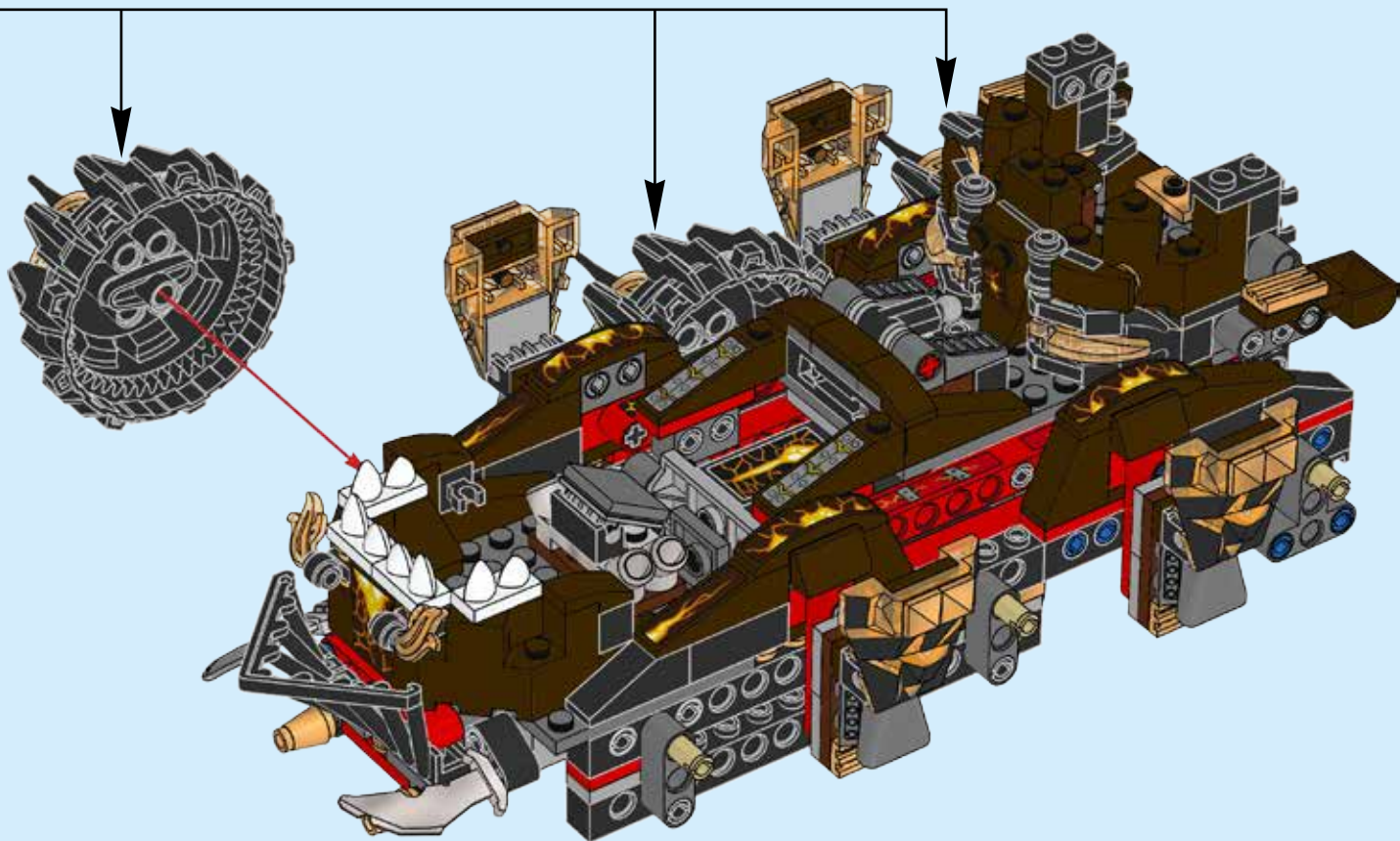

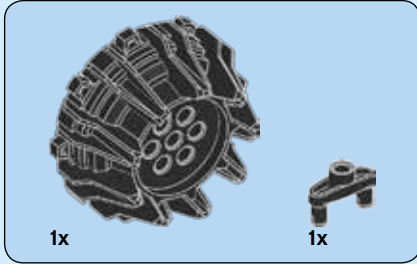

# 130

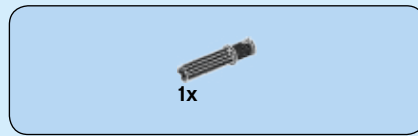
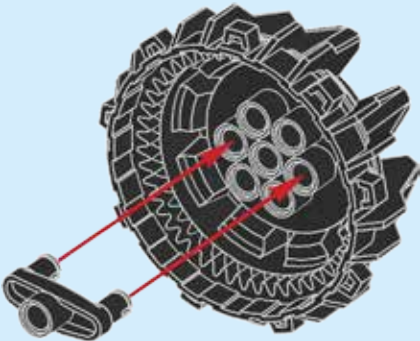

# 131

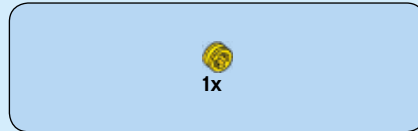
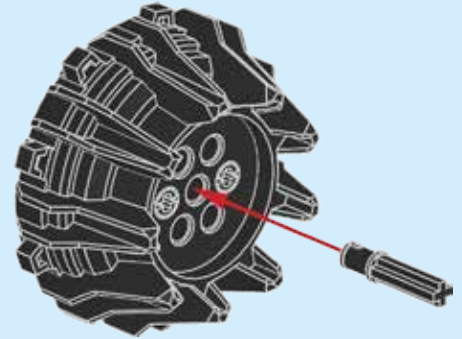
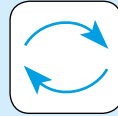

# 132





1x

133



1x



1x

134

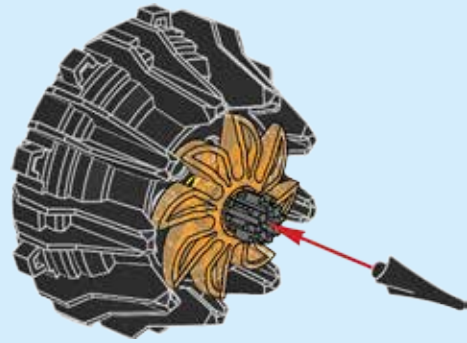

3x

135

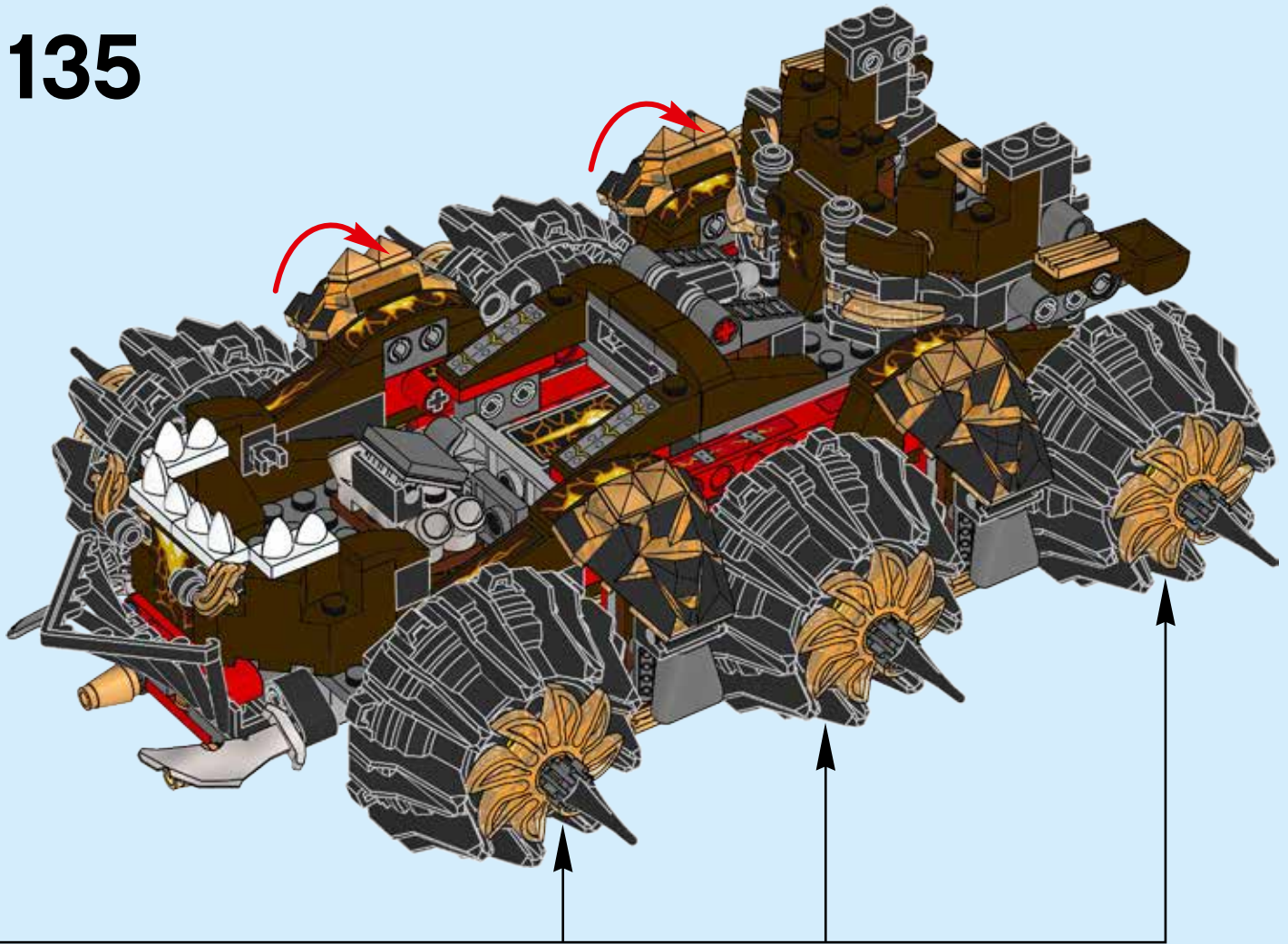

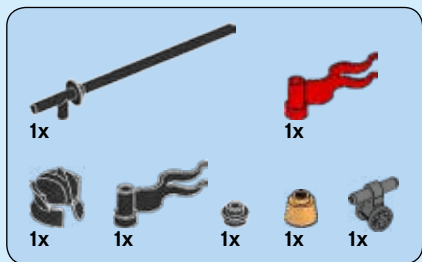

# 136

1



2

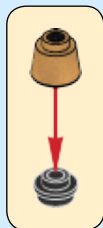

3



4



5



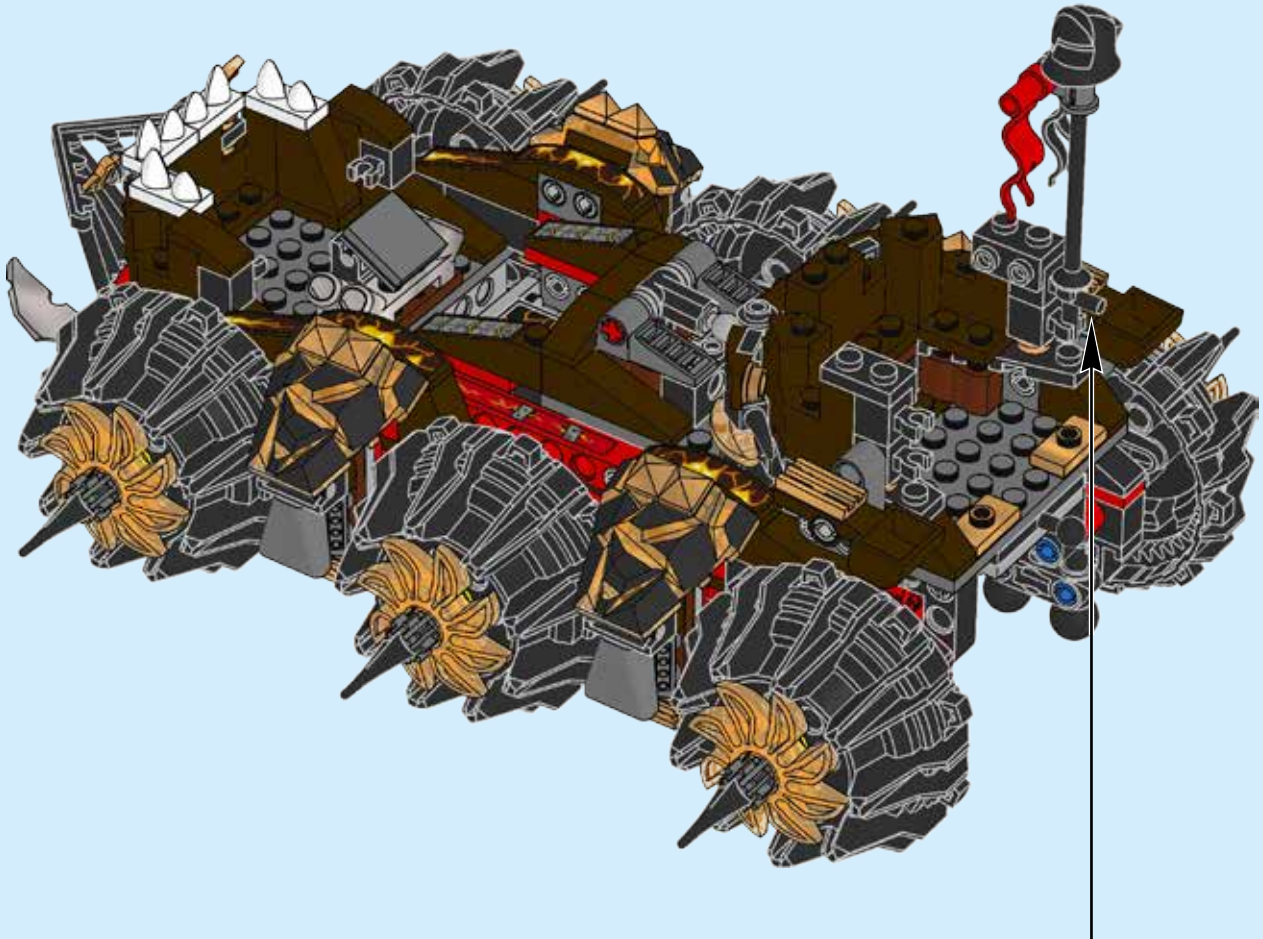
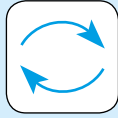

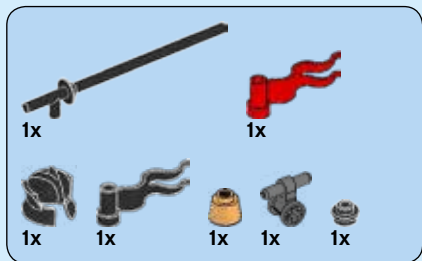

# 137

1



2

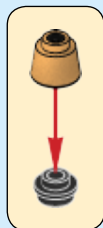

3



4



5





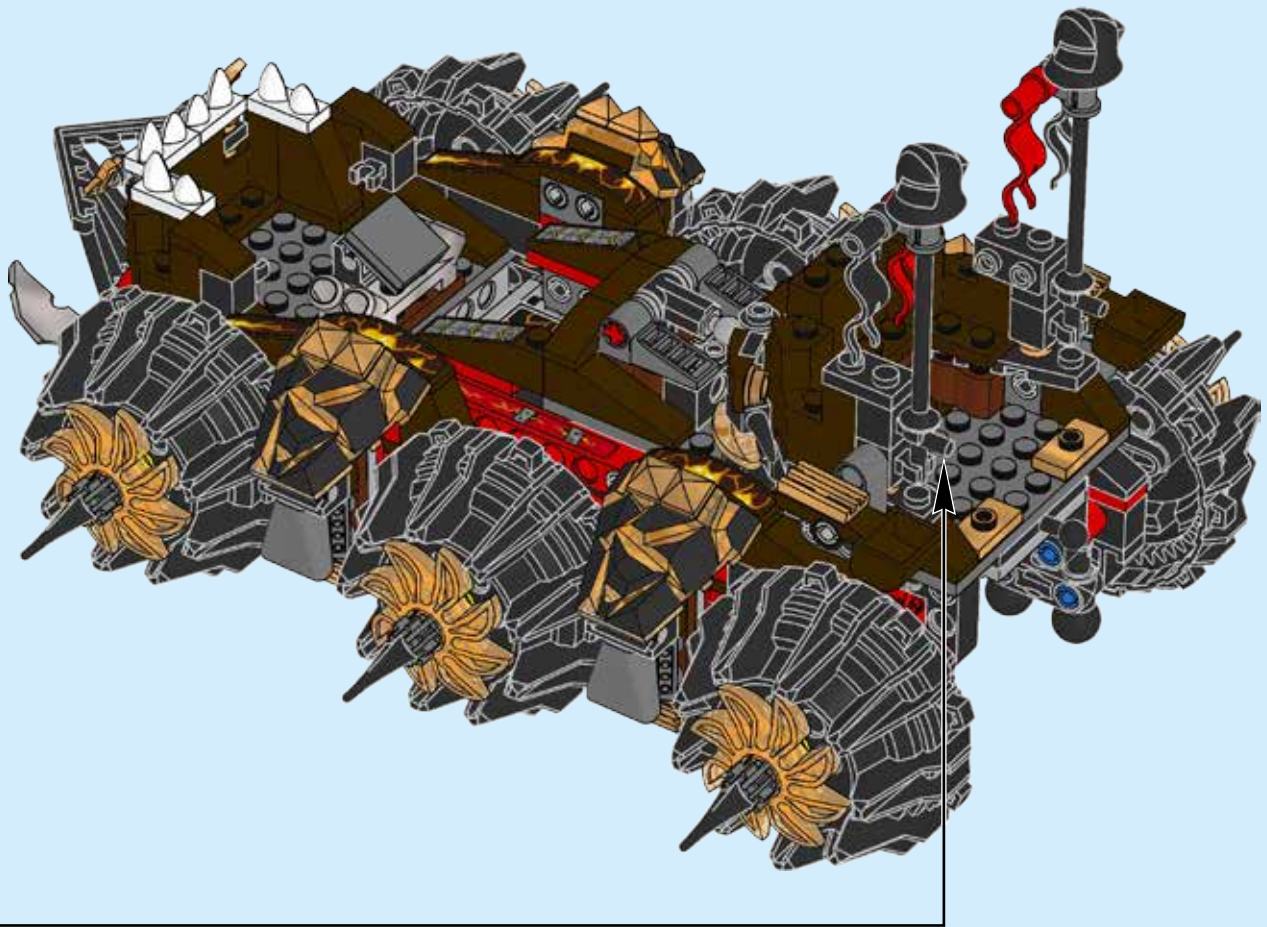



1x



2x



2x



2x

# 138

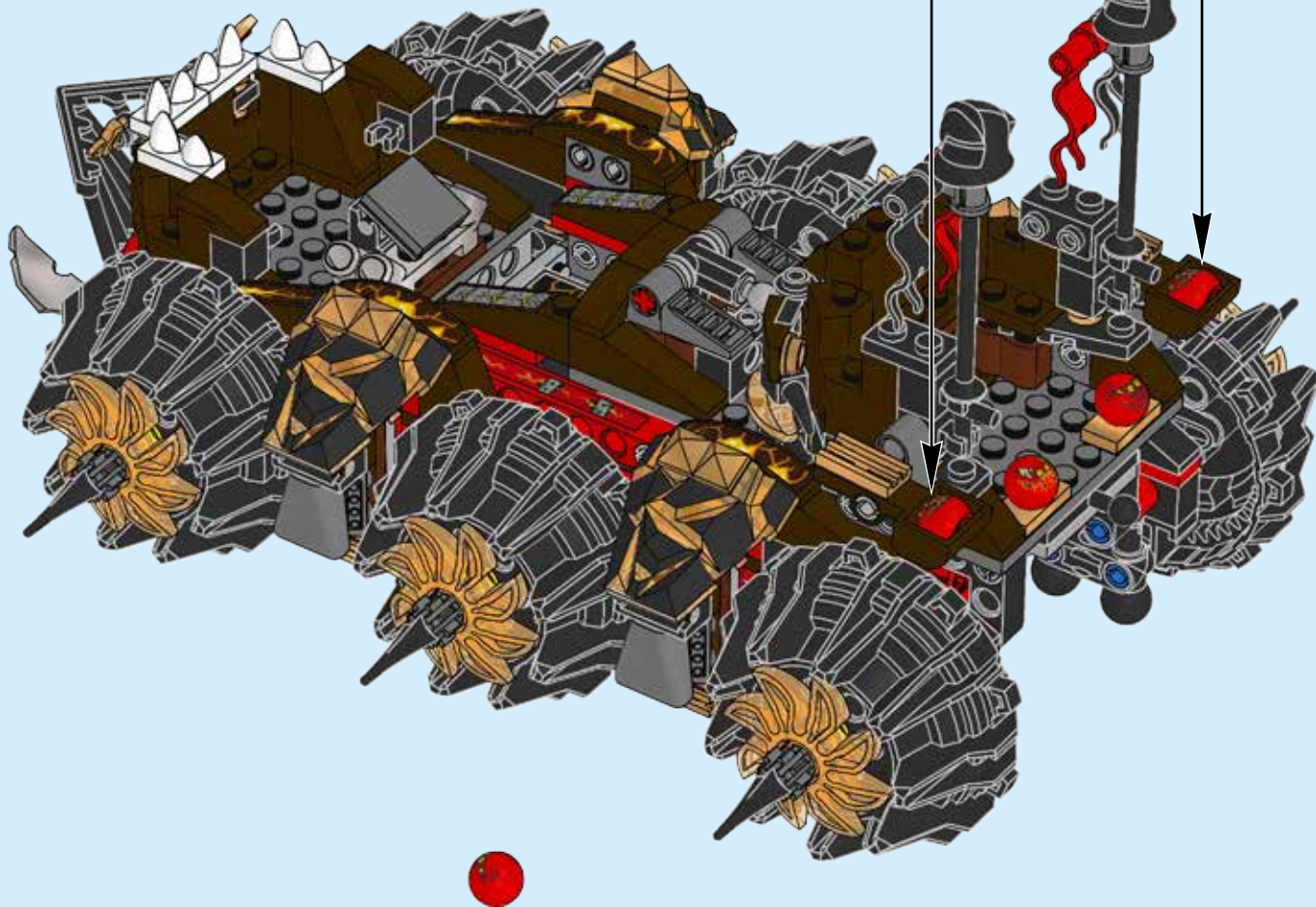



2x



2x

# 139

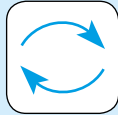

140

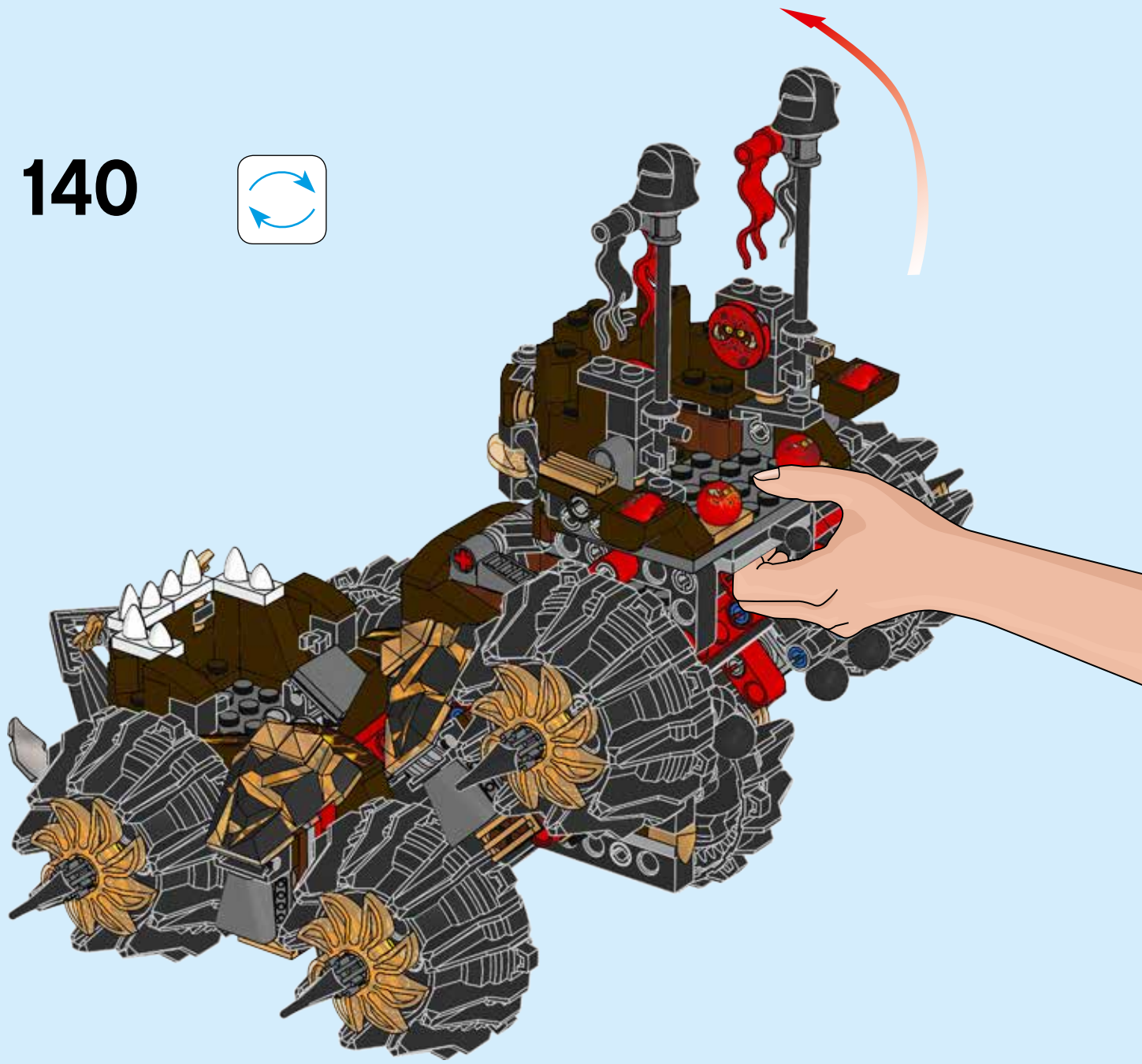
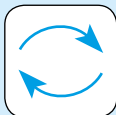



141

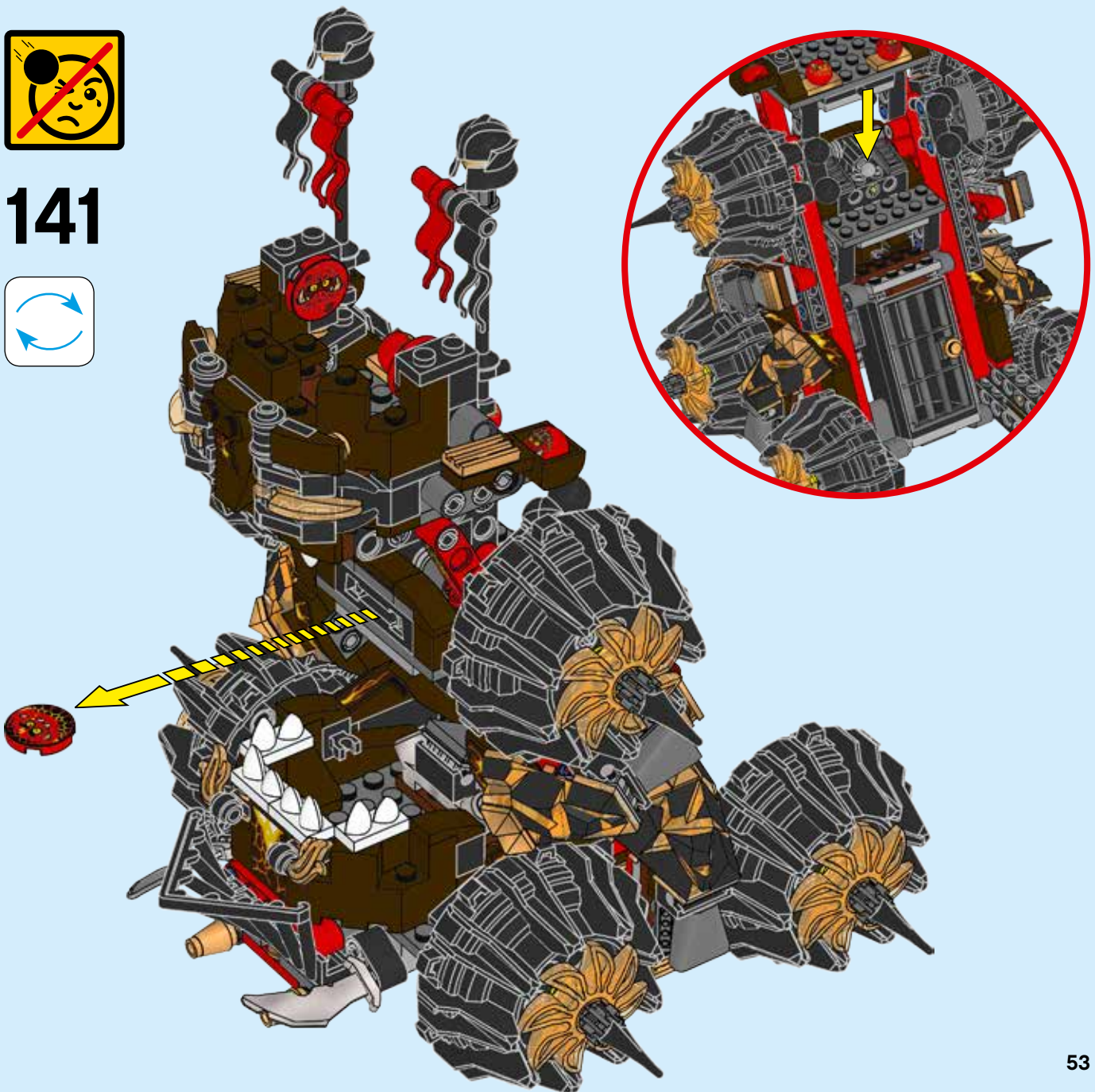

142

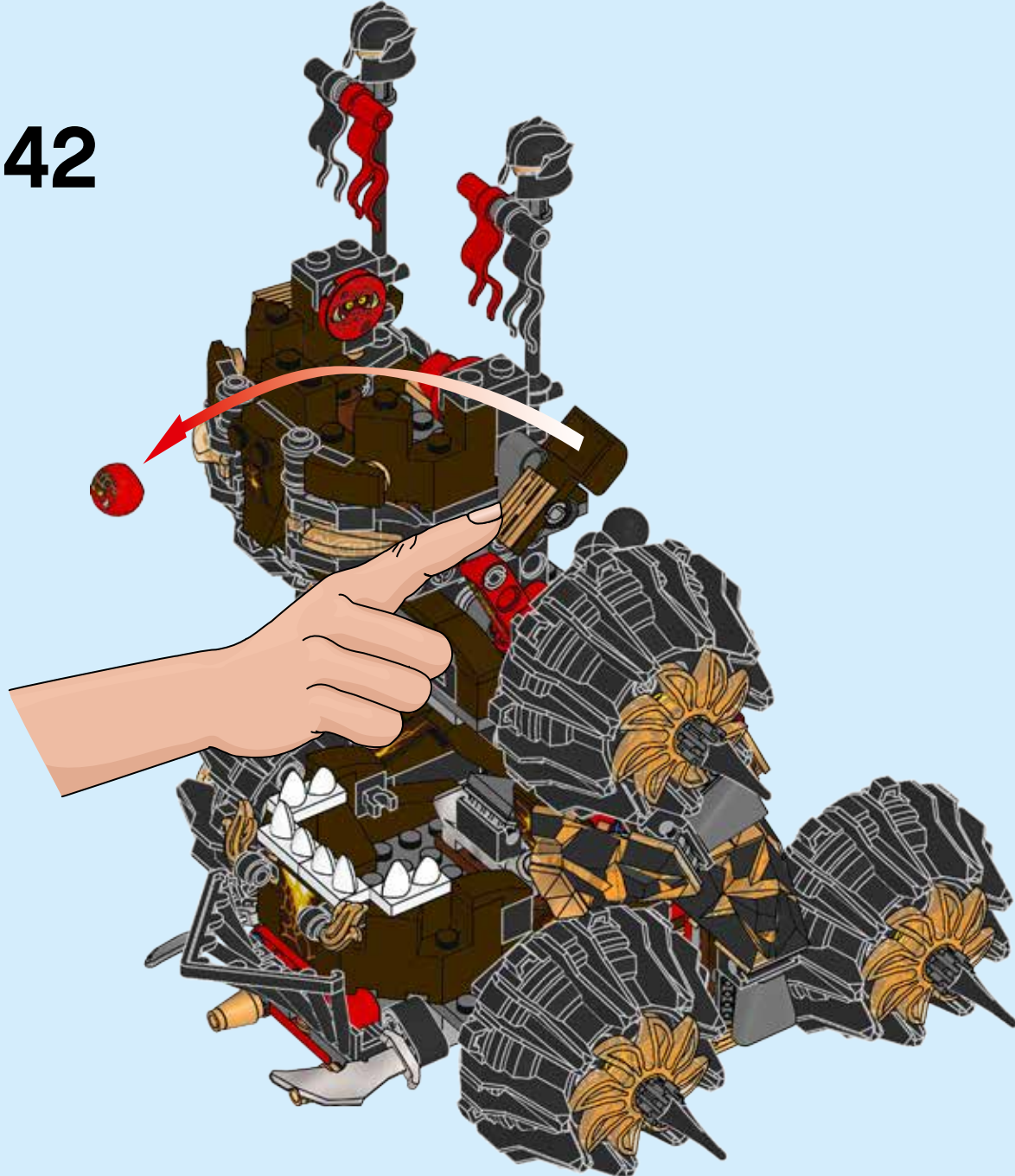

143



|                                                                                                    |                                                                                                      |                                                                                                      |                                                                                                      |                                                                                                       |                                                                                                        |                                                                                                        |
|----------------------------------------------------------------------------------------------------|------------------------------------------------------------------------------------------------------|------------------------------------------------------------------------------------------------------|------------------------------------------------------------------------------------------------------|-------------------------------------------------------------------------------------------------------|--------------------------------------------------------------------------------------------------------|--------------------------------------------------------------------------------------------------------|
| <br>2x<br>4224792     | <br>2x<br>4128594     | <br>17x<br>4514553    | <br>1x<br>6125721     | <br>4x<br>362226       | <br>1x<br>4535834     | <br>1x<br>6131162     |
| <br>4x<br>6046384   | <br>4x<br>4513987   | <br>1x<br>4520946   | <br>1x<br>4107767   | <br>2x<br>4636201    |                                                                                                        | <br>1x<br>6131162   |
| <br>1x<br>6046381   | <br>7x<br>362321    | <br>1x<br>4508613   | <br>2x<br>6006140   | <br>3x<br>302126     |                                                                                                        | <br>1x<br>6133167   |
| <br>1x<br>6013938   | <br>1x<br>6141776   | <br>2x<br>4206482   | <br>1x<br>6129476   | <br>1x<br>4516020    | <br>1x<br>4271754   | <br>1x<br>6136406   |
| <br>1x<br>6134987   | <br>1x<br>6129771   | <br>2x<br>4632567   | <br>5x<br>393726    | <br>1x<br>6133717    |                                                                                                        | <br>1x<br>6136406   |
| <br>6x<br>4514554   | <br>1x<br>6129780   | <br>1x<br>4140586   | <br>5x<br>6000650   | <br>1x<br>6133717    | <br>4x<br>4142823   | <br>1x<br>6055631   |
| <br>1x<br>6137300   | <br>1x<br>6129780   | <br>1x<br>4568990   | <br>4x<br>6016172   | <br>1x<br>370126     |                                                                                                        | <br>2x<br>4504374   |
| <br>1x<br>6137305   | <br>1x<br>6141862   | <br>2x<br>6035354   | <br>4x<br>6055630   | <br>1x<br>4160869    | <br>2x<br>384926    | <br>1x<br>6127054   |
| <br>6x<br>4239601   | <br>2x<br>449521    | <br>4x<br>4632571   | <br>2x<br>4584274   | <br>1x<br>4161332    | <br>1x<br>6097109   | <br>1x<br>4540280   |
| <br>1x<br>6124891   | <br>1x<br>6129995   | <br>4x<br>4144023   | <br>6x<br>6055630   | <br>1x<br>4160869    | <br>1x<br>6097109   | <br>1x<br>4540280   |
| <br>2x<br>6129756   | <br>1x<br>371021    | <br>6x<br>6135009   | <br>2x<br>6093525   | <br>8x<br>4533771    | <br>6x<br>4538782   | <br>1x<br>6124899   |
| <br>2x<br>6132361   | <br>5x<br>4142132   | <br>6x<br>6100627   | <br>8x<br>6089119   | <br>2x<br>4226000    | <br>6x<br>4538782   | <br>2x<br>6129858   |
| <br>1x<br>6129616 | <br>2x<br>447721  | <br>4x<br>4568385 | <br>2x<br>4593576 | <br>30x<br>4121715 | <br>2x<br>273026  | <br>1x<br>6018481 |
| <br>2x<br>6132545 | <br>4x<br>4542575 | <br>2x<br>4550017 | <br>4x<br>428626  | <br>4x<br>6006739  | <br>4x<br>4107558 | <br>1x<br>6134289 |
| <br>2x<br>6132546 |                                                                                                      |                                                                                                      |                                                                                                      |                                                                                                       |                                                                                                        |                                                                                                        |





Customer Service

Kundenservice

Service Consommateurs

Servicio Al Consumidor

LEGO.com/service or dial



: 00800 5346 5555

: 1-800-422-5346



# NEXO KNIGHTS



DOWNLOAD THE FREE APP



LEGO® NEXO KNIGHTS™: MERLOK 2.0



1



2



3

DOWNLOAD THE FREE APP/KOSTENLOSE APP HERUNTERLADEN/TÉLÉCHARGE L'APPLI GRATUITE  
DESCARGA LA APP GRATIS/DESCARREGA A APP GRATIS/TÖLTSD LE AZ INGYENES APPOT!/ 下载免费 APP  
DEVICE CHECK;/GERÁT PRÜFEN;/VERIFICATION DE COMPATIBILITE :  
COMPRUEBA TU DISPOSITIVO;/VERIFICAÇÃO DO DISPOSITIVO;/ESZKÖZELLENÖRZÉS;/设备检查:

[LEGO.com/devicecheck](http://LEGO.com/devicecheck)



# NEXO KNIGHTS



## SCANNING TIPS

Scanning Tips / Tipps zum Scannen / Conseils de scannage /  
Consejos para escanear / Dicas para o scan / Beolvasási tippek / 扫描秘诀





# NEXO KNIGHTS



LEGO  
LEGOLAND  
DISCOVERY CENTER



# LEGOLAND



DOWNLOAD THE FREE APP: /KOSTENLOSE APP  
HERUNTERLADEN; /TÉLÉCHARGE L'APPLI GRATUITE :/  
DESCARGA LA APP GRATIS; /DESCARREGA A APP GRÁTIS;/  
TÖLTSD LE AZ INGYENES ÁPPOTI; /下载免费 APP:  
LEGO® NEXO KNIGHTS™: MERLOK 2.0

ALL MATERIALS MIGHT NOT BE  
AVAILABLE IN ALL MARKETS.  
MÖGLICHERWEISE IST NICHT DAS GANZE MATERIAL IN ALLEN  
MÄRKTEN VERFÜGBAR. /CERTAINS PRODUITS PEUVENT NE  
PAS ÊTRE DISPONIBLES SUR CERTAINS MARCHÉS. /CIERTOS  
MATERIALES PODRÍAN NO ESTAR DISPONIBLES EN TODOS  
LOS MERCADOS. /OS MATERIAIS PODERÃO NÃO ESTAR TODOS  
DISPONÍVEIS EM TODOS OS MERCADOS. /ELKEPZELHETŐ,  
HOGY BIZONYOS KIEGÉSZÍTŐK A TE ORSZÁGODBAN NEM  
ELÉRHETŐEK. /部分内容可能不适用于某些国家/地区

[LEGO.COM/NEXOKNIGHTS](http://LEGO.COM/NEXOKNIGHTS)

  
**LEGOLAND**  
RESORTS

BILLUND • DEUTSCHLAND  
WINDSOR • MALAYSIA • DUBAI



**NEU LEGO® NEXO KNIGHTS™ 4D-Film**

**NOUVEAU LEGO® NEXO KNIGHTS™  
Film 4D**

**NUEVO LEGO® NEXO KNIGHTS™  
Película 4D**

**NOVO LEGO® NEXO KNIGHTS™  
4D filme**

LEGO, the LEGO logo and NEXO KNIGHTS are trademarks of the LEGO Group. ©2016 The LEGO Group. LEGOLAND is a part of Merlin Entertainments plc.

  
**NEXO KNIGHTS** 

**NEW**



**LEGO® NEXO KNIGHTS™  
4D Movie**

**ÚJ LEGO® NEXO KNIGHTS™ 4D film**

**全新LEGO® NEXO KNIGHTS™4D电影**

**NY LEGO® NEXO KNIGHTS™ 4D film**

**新しいLEGO® NEXO KNIGHTS™  
の4D映画!**

**Yeni LEGO® NEXO KNIGHTS™ 4D film!**

  
**LEGOLAND**  
DISCOVERY CENTRE

Manchester • Berlin  
Oberhausen • Istanbul • Osaka





# NEXO KNIGHTS





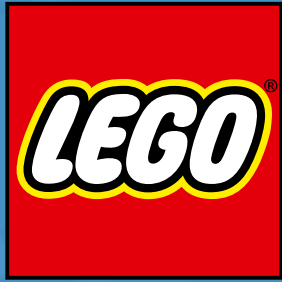

# club™

