



# Architecture

21045

## Trafalgar Square

London, Great Britain



Booklet available in English on  
Heft in deutscher Sprache erhältlich auf  
Livret disponible en français sur  
Libretto disponibile in italiano su  
Folleto disponible en español en  
Folheto disponível em português em  
A füzet magyarul ezen a honlapon olvasható:  
Buklets latviešu valodā pieejams vietnē  
如需中文版手册, 请访问

[LEGO.com/architecture](http://LEGO.com/architecture)





# A Part of the Fabric of London

Think of a “London landmark” and Trafalgar Square will quickly come to mind. A public square in the City of Westminster, it is a space that has played a key part in the history and culture of London since the thirteenth century.

Originally called the Royal Mews, the area was re-developed by architect John Nash as a public space for culture and arts and named Trafalgar Square in 1830, to commemorate the British naval victory at the Battle of Trafalgar.

Trafalgar Square remains an arena for national democracy, protests and demonstrations. However, it is also home to festive Christmas and New Year’s Eve celebrations, where people gather around the giant tree that has been donated by Norway every year since 1947.

# The National Gallery

The National Gallery houses collections of important paintings from the mid thirteenth century until 1900. William Wilkins designed and built the imposing building between 1832 and 1838 on the site of the former Royal Mews; the location was important as it allowed all classes and neighborhoods to access the art.

Although the front façade remains almost the same, the building itself has changed and evolved since then, including the development of the post-modern Sainsbury Wing extension to the west.



# Nelson's Column

This monument was created by architect William Railton to honor Admiral Horatio Nelson, who led the British to victory and died at the Battle of Trafalgar. The iconic Corinthian column was completed in 1854, but the four majestic lions that guard the sculpture were installed many years later, in 1867.





## The Fountains

Charles Barry originally created the fountains as a way of offsetting the glare and heat reflected on the large amounts of asphalt surface on the square. The centerpieces were replaced in the 1930s as memorials to naval officers, Lord Jellicoe and Lord Beatty, with the old centerpieces being gifted to the Canadian government.

# The Plinths and Sculptures

The eastern plinth has a bronze statue of George IV (nicknamed "the first gentleman of England") on a horse, created by English sculptor Francis Chantrey and installed in 1844. In 1855 the plinth in the southwest corner received a statue of British Army veteran, Charles James Napier, by sculptor George Gammon Adams. The statue of Sir Henry Havelock, by William Behnes, was placed on the southeast plinth in 1861.

After many years of debate about the fate of the empty 'Fourth Plinth', it has since been used for a rotation of temporary modern artworks, a concept initiated by the Royal Society of Arts.



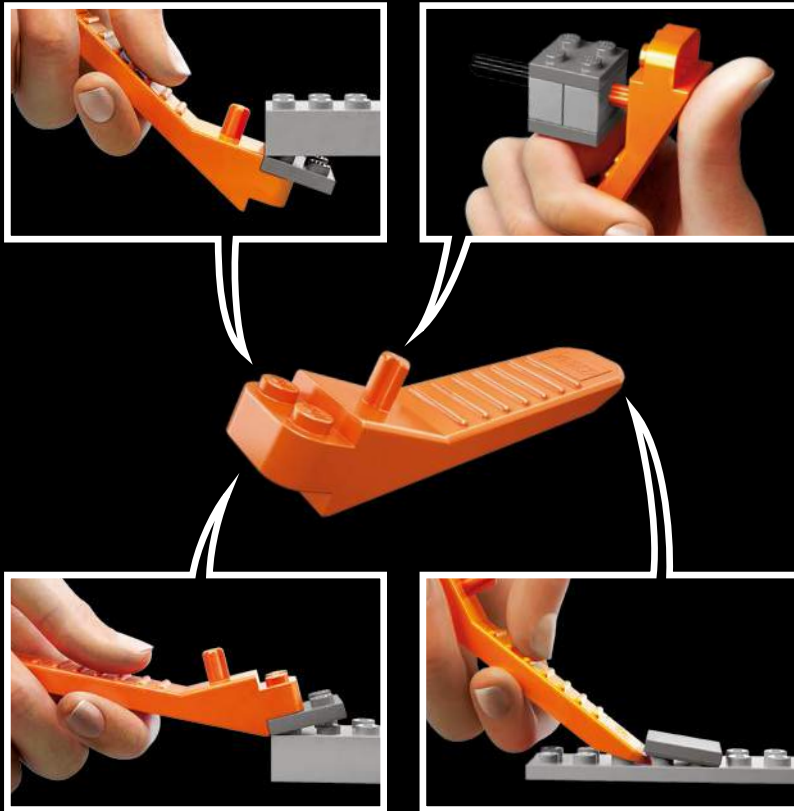





- 1** Download the LEGO® Life App  
 Lade dir die LEGO® Life App herunter  
 Télécharge l'application LEGO® Life  
 Télécharger l'application LEGO® Life  
 Scarica l'app LEGO® Life  
 Descarga la app LEGO® Life  
 Descarrega a App LEGO® Life  
 Töltsd le a LEGO® Life Appot!  
 Lejupielādē lietotni LEGO® Life  
 下載 LEGO® Life 应用程序



- 2** Scan the code on the front cover  
 Scanne den Code auf der Titelseite  
 Scanne le code sur la page de  
 couverture  
 Scanner le code sur la page  
 couverture  
 Scansiona il codice sulla copertina  
 Escanea el código de la portada  
 Faz scan do código na frente da capa  
 Olvasd be a borítón látható kódot!  
 Noskenē kodu uz priekšējā vāka  
 扫描封面上的二维码



- 3** Get the Building Instructions  
 Hol dir die Bauanleitung  
 Obtens les instructions de montage  
 Obtenir les instructions de montage  
 Scarica le istruzioni per la  
 costruzione  
 Consulta las instrucciones de  
 construcción  
 Obtém as Instruções de Construção  
 Szerezd be az építési útmutatókat!  
 Saņem būvēšanas instrukcijas  
 获取拼搭说明

**LEGO.com/apps**

Check for compatibility  
 Kompatibilität prüfen  
 Vérifier la compatibilité  
 Controlla la compatibilità  
 Comprueba tu compatibilidad

Verificar a compatibilidade  
 Ellenőrizd a kompatibilitást  
 Pārbaudīt saderību  
 检查兼容性

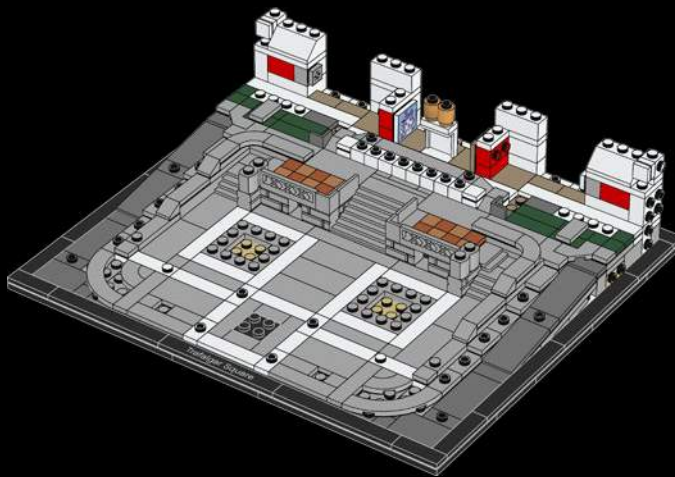
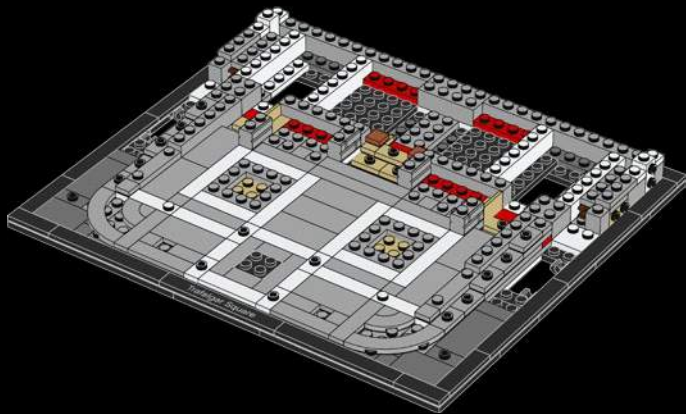

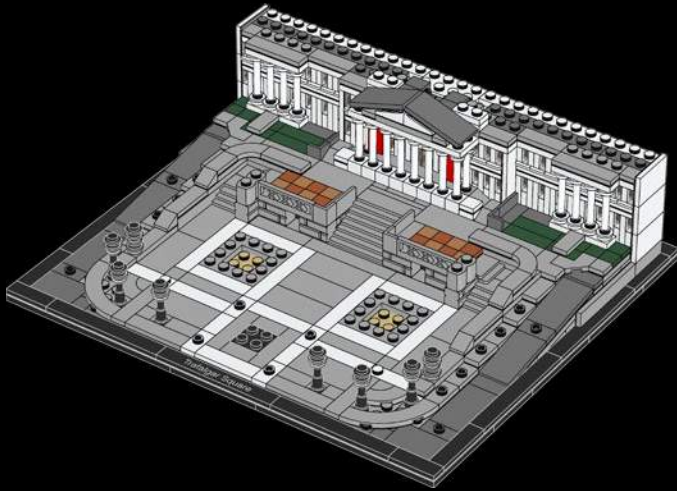

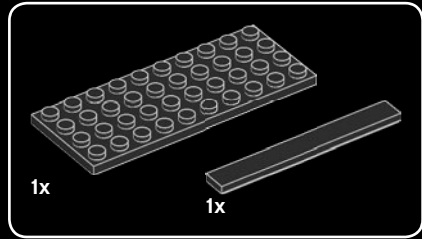
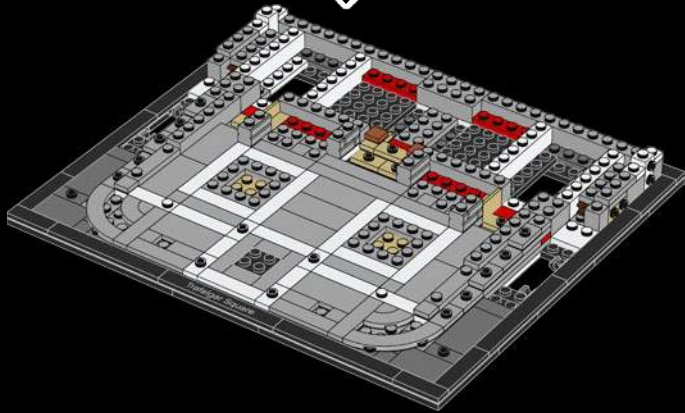
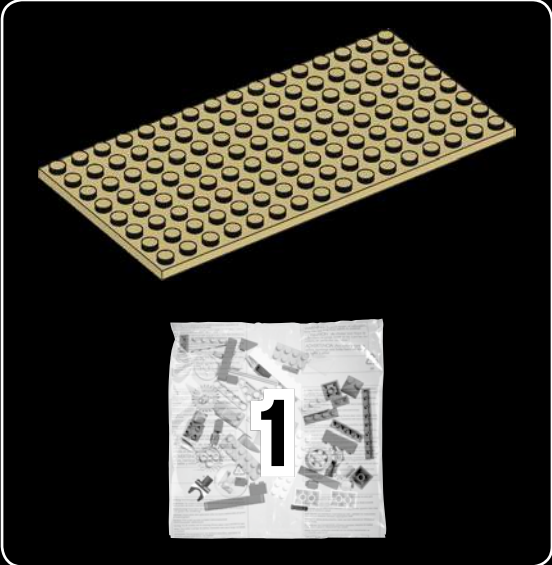

1

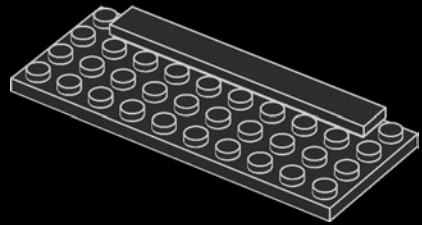

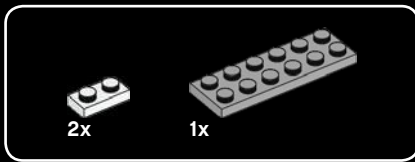

2

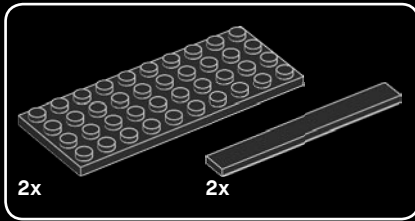
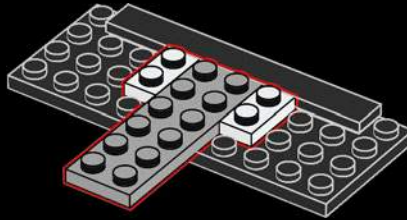

3

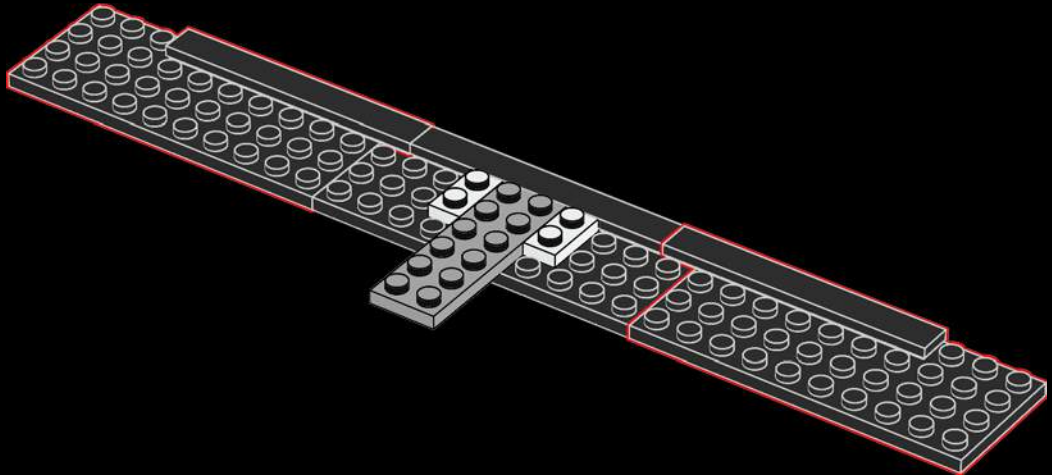

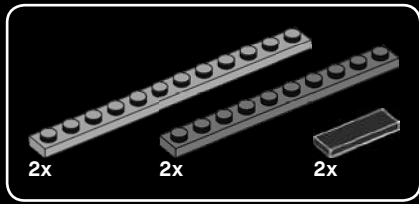

4

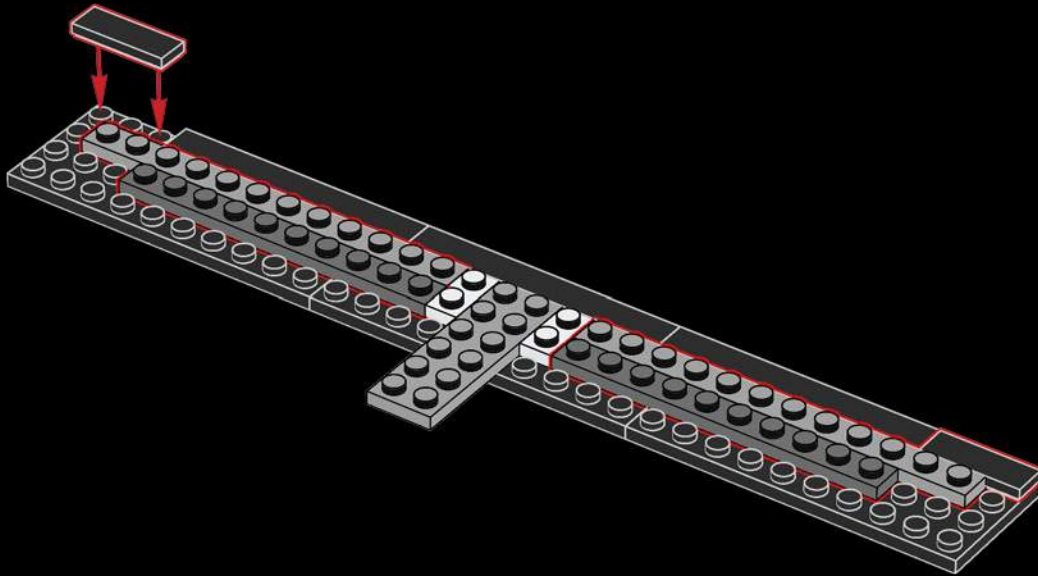

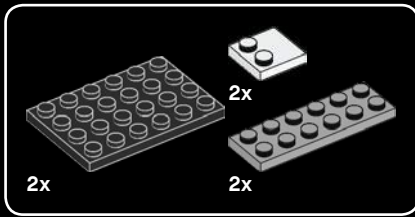

5

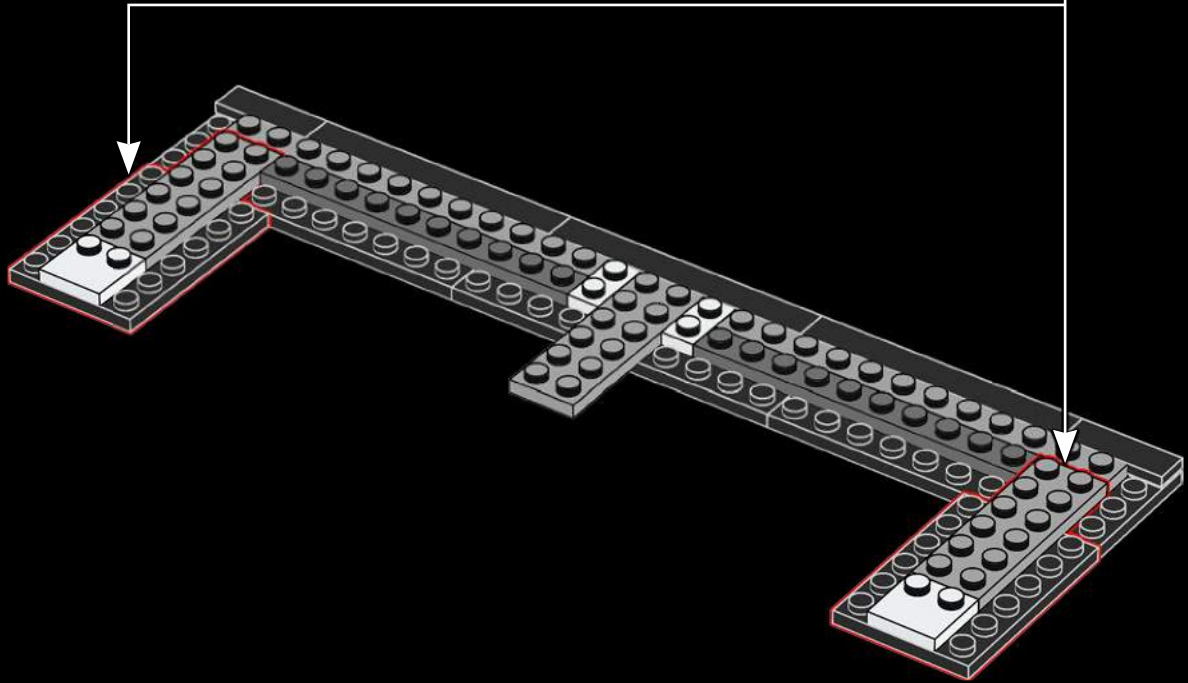
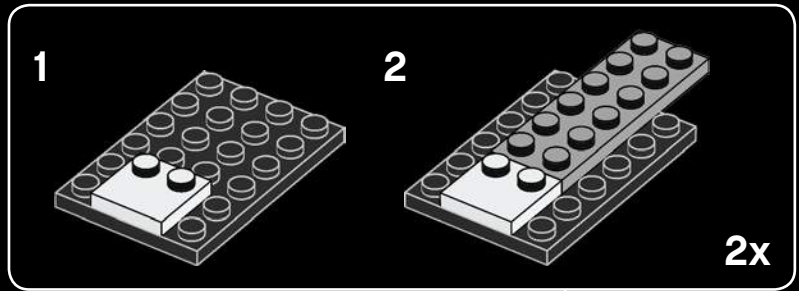

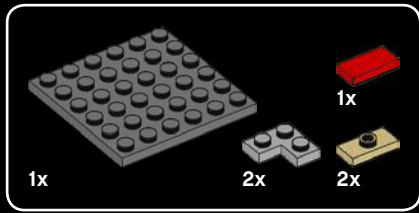

6

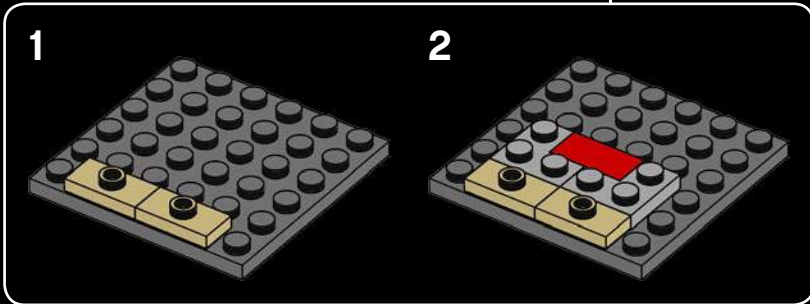
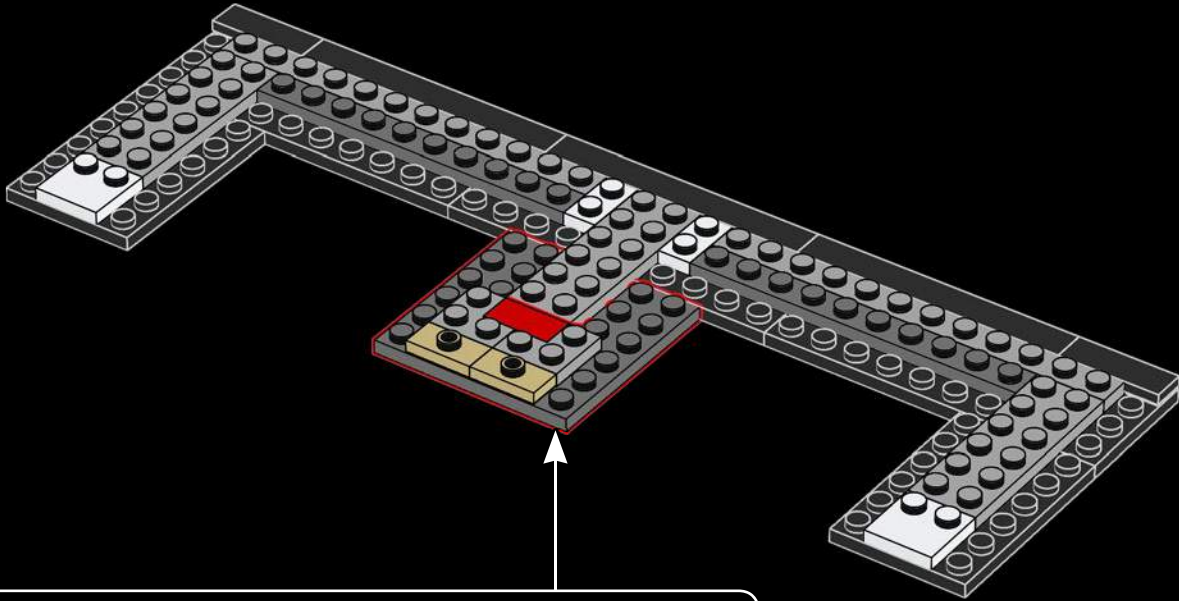



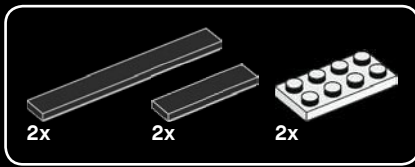

7

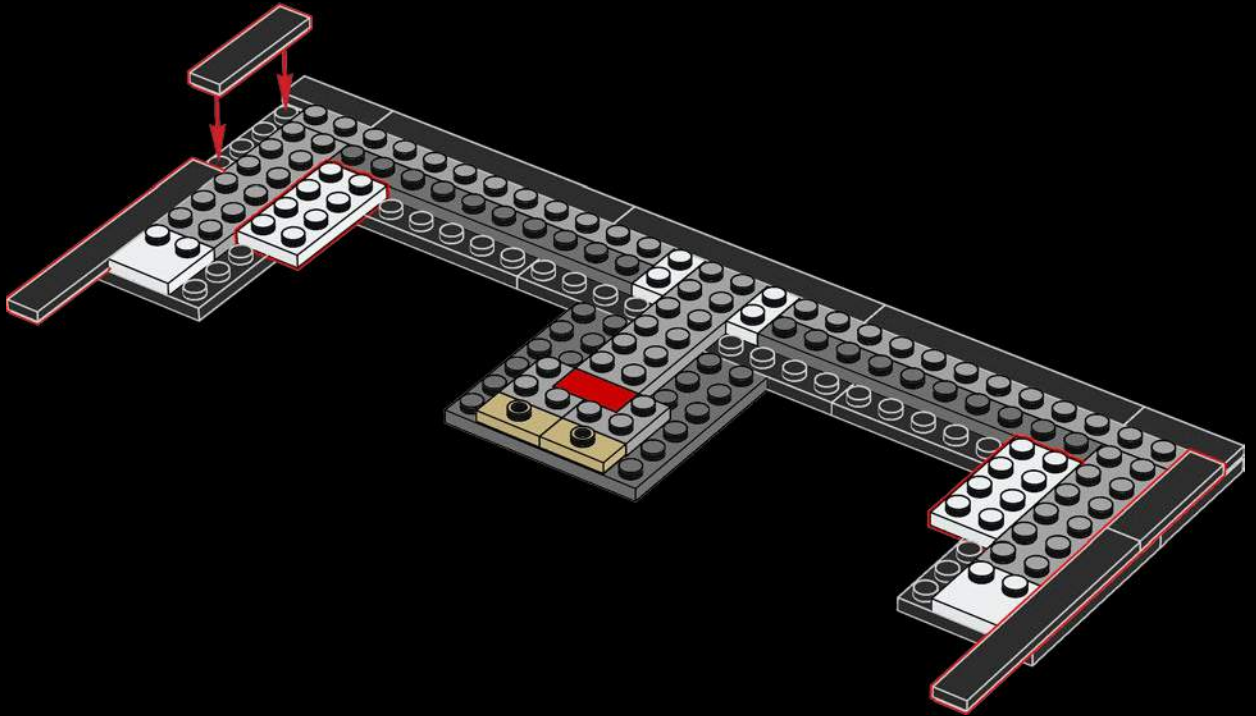

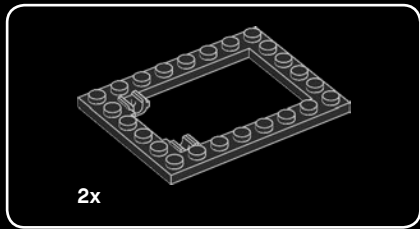

8

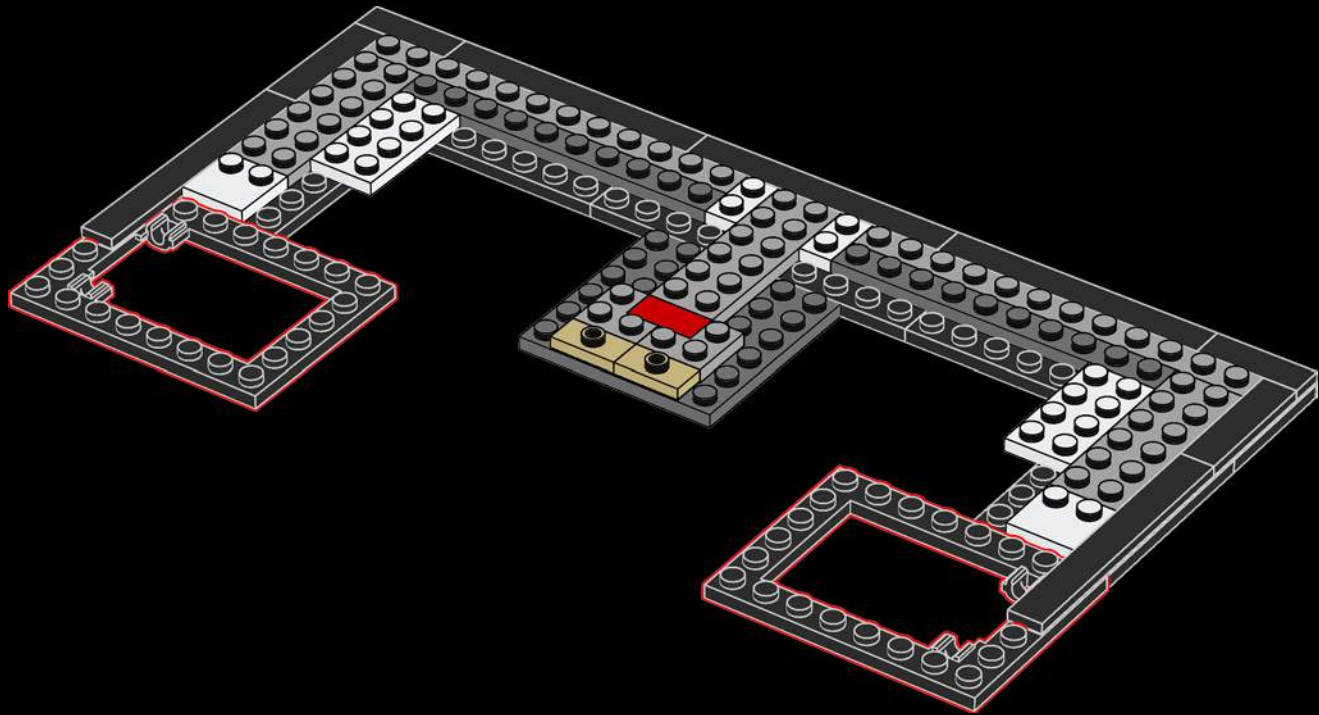

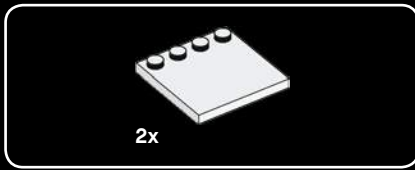

9

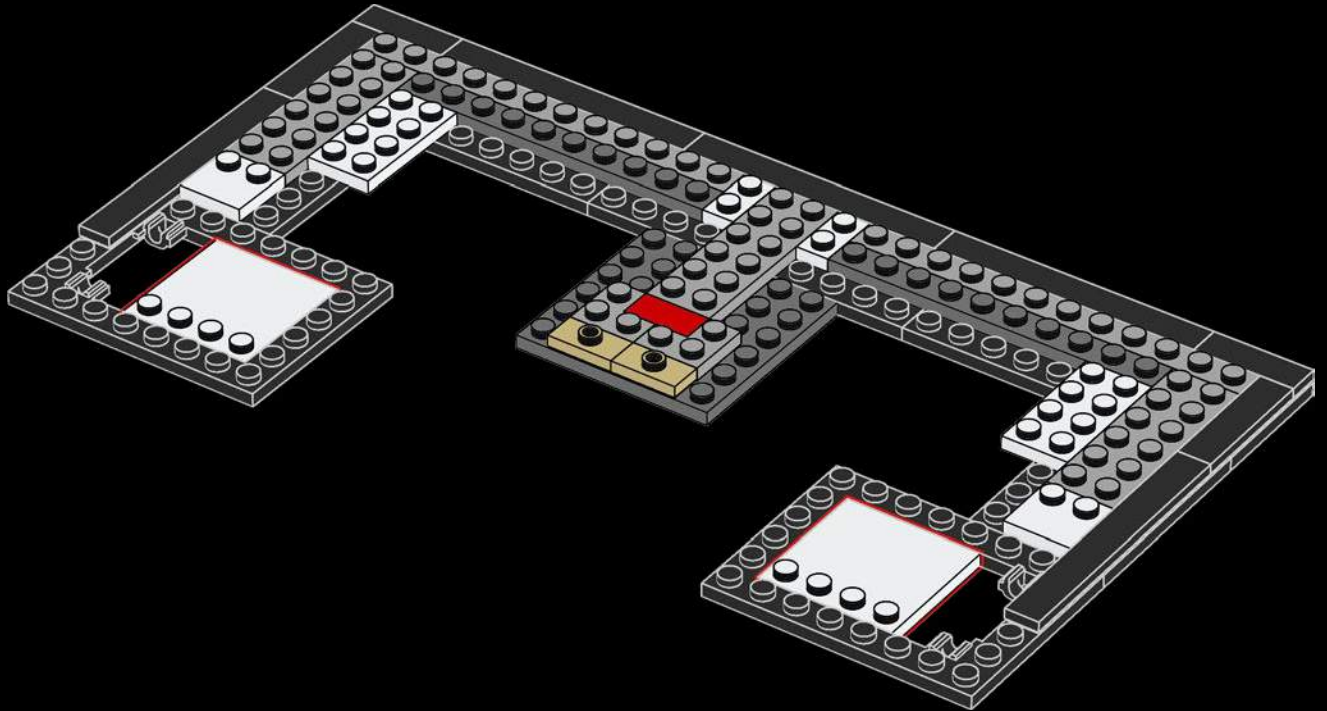

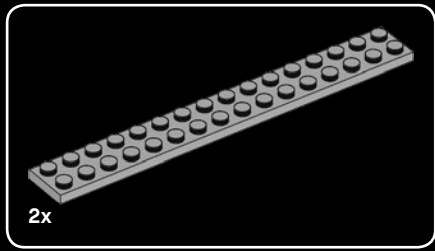

10

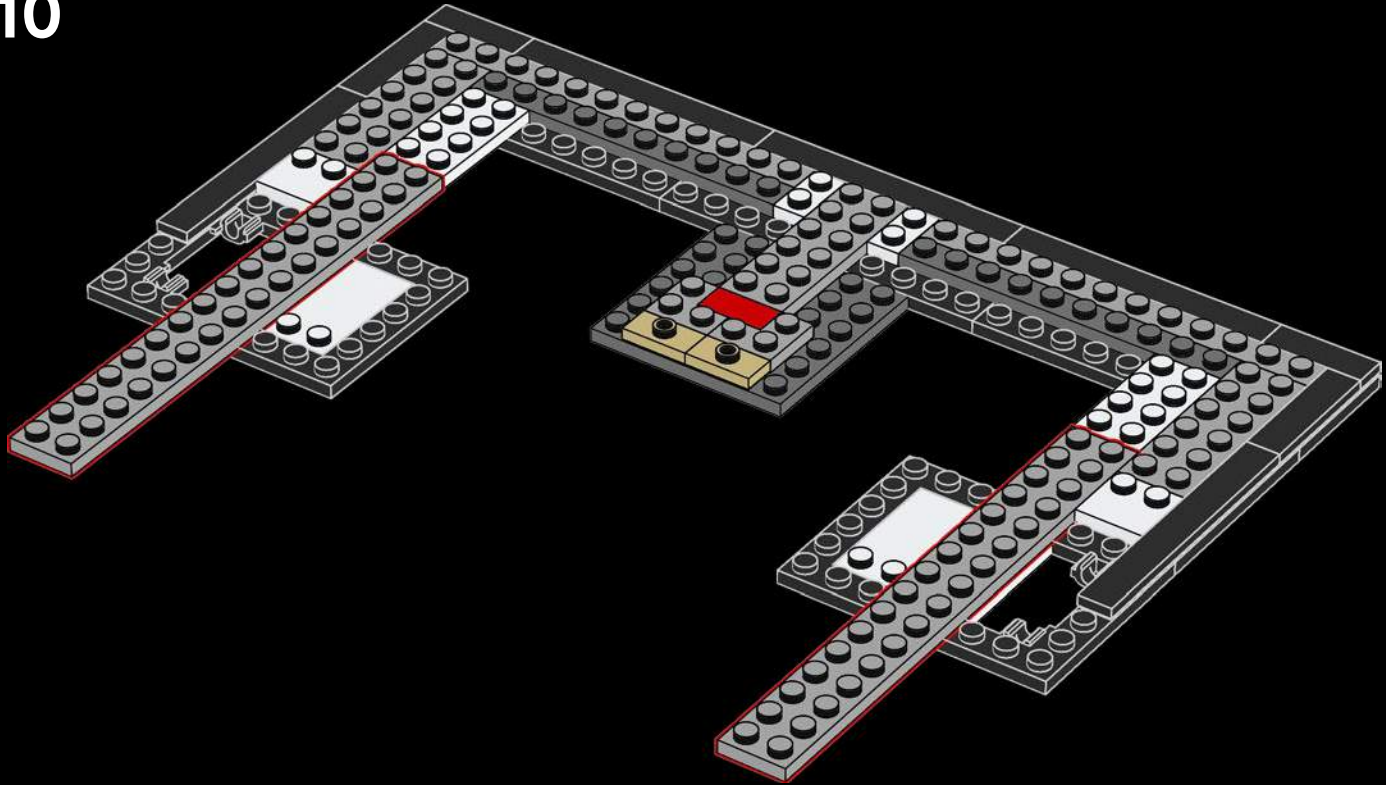

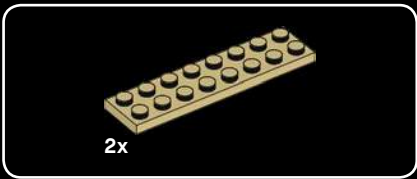

11

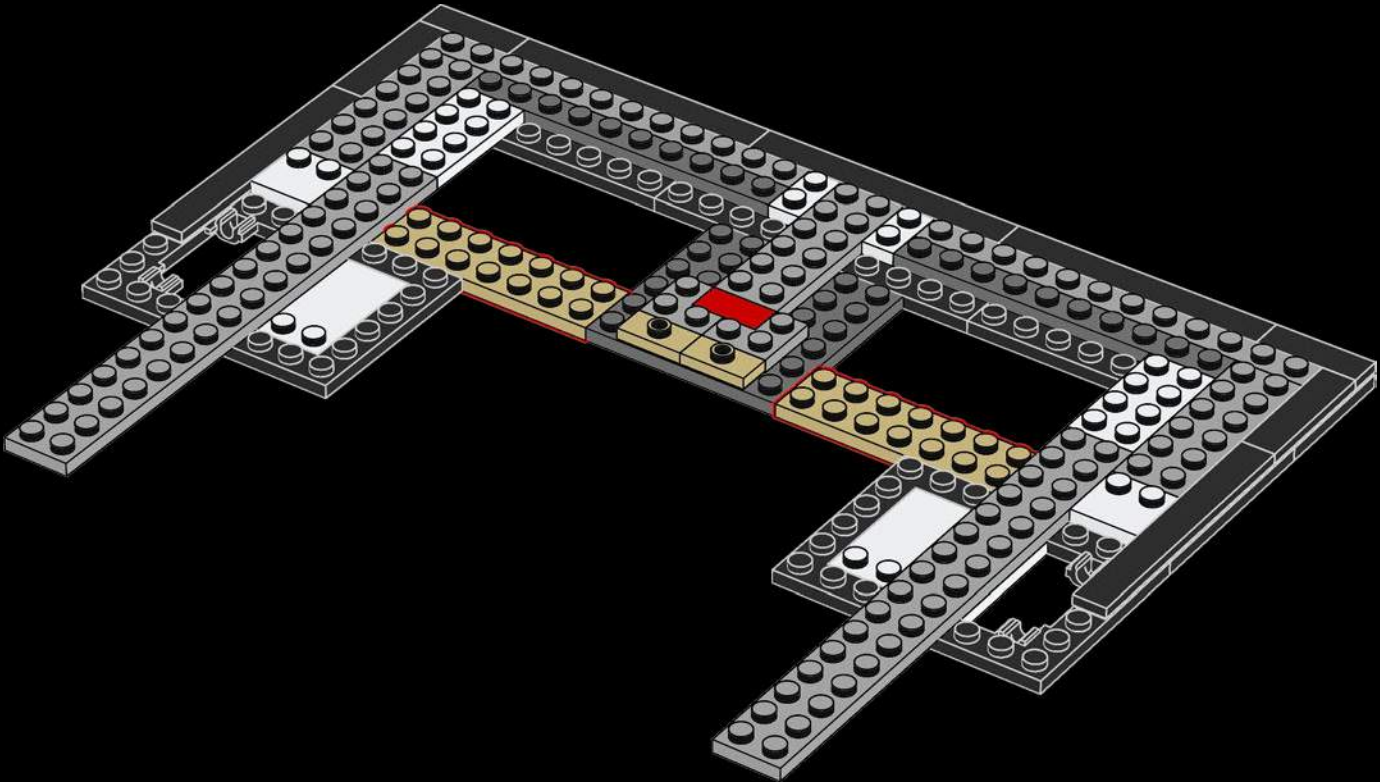

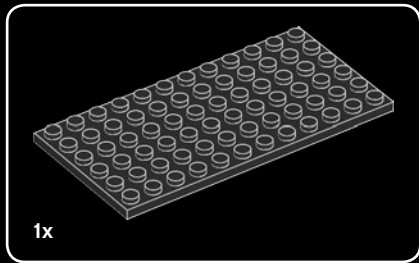

12

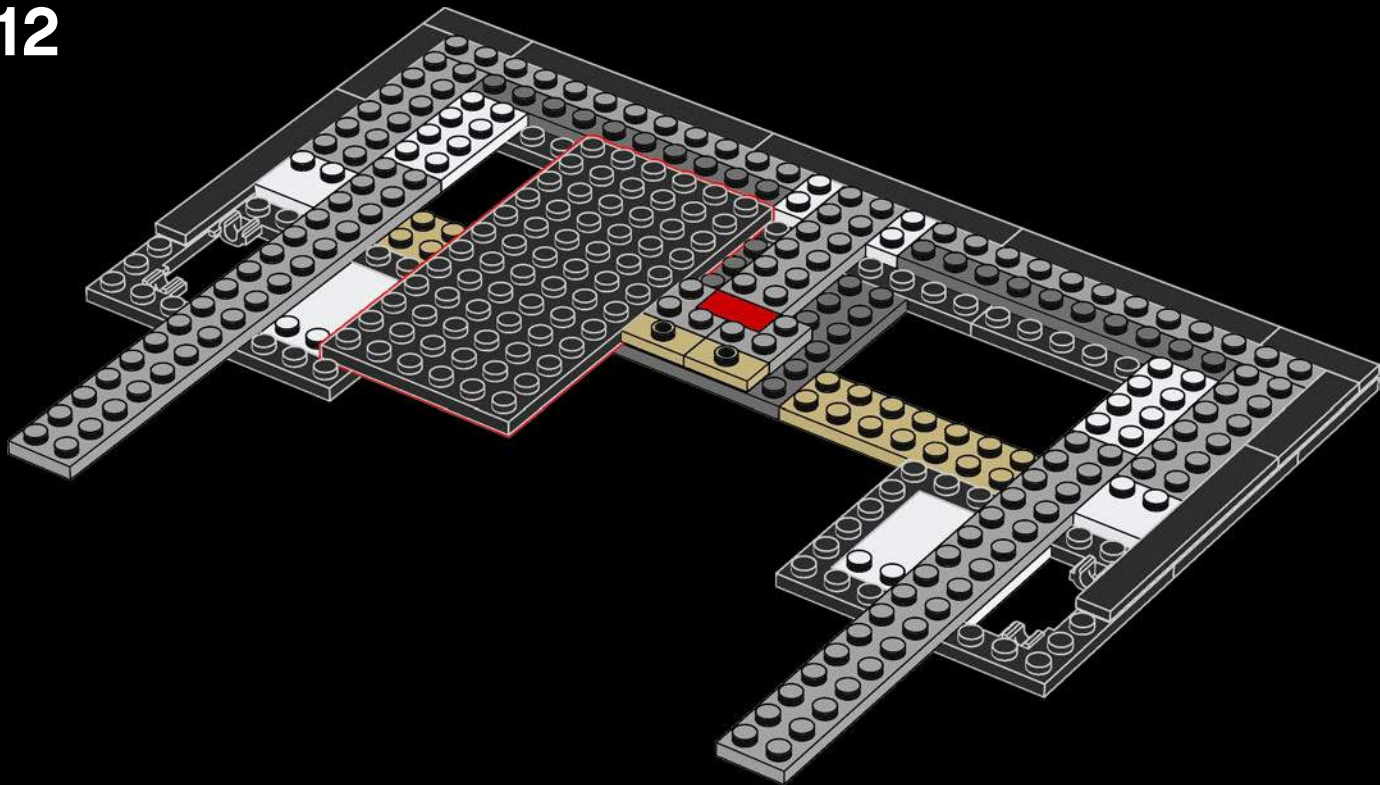

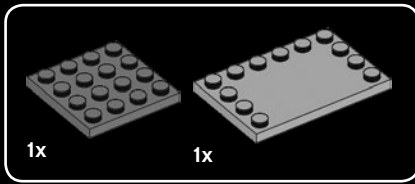

13

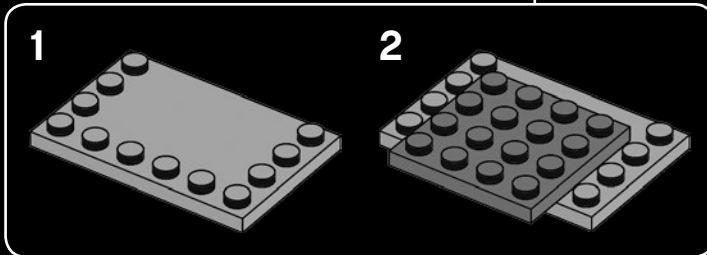
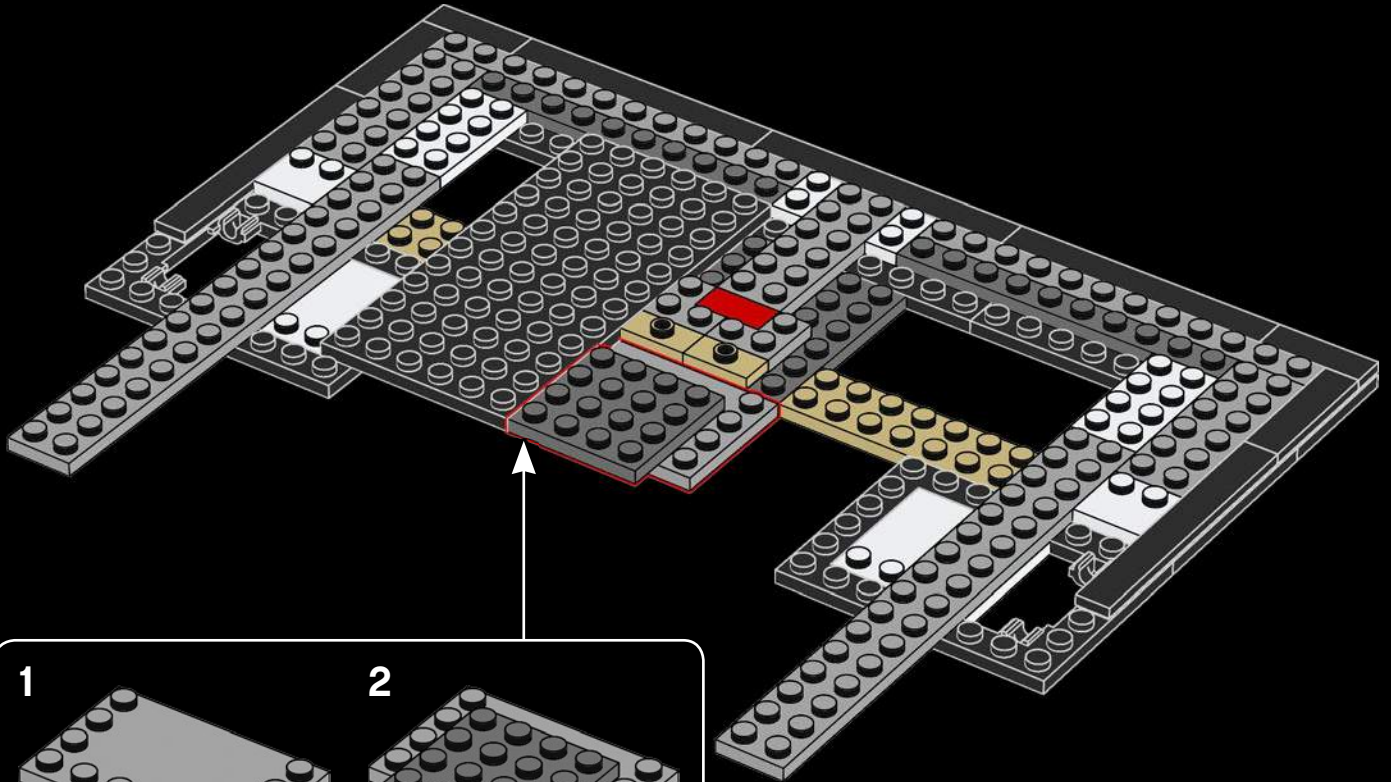

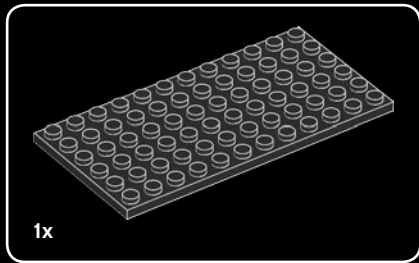

14

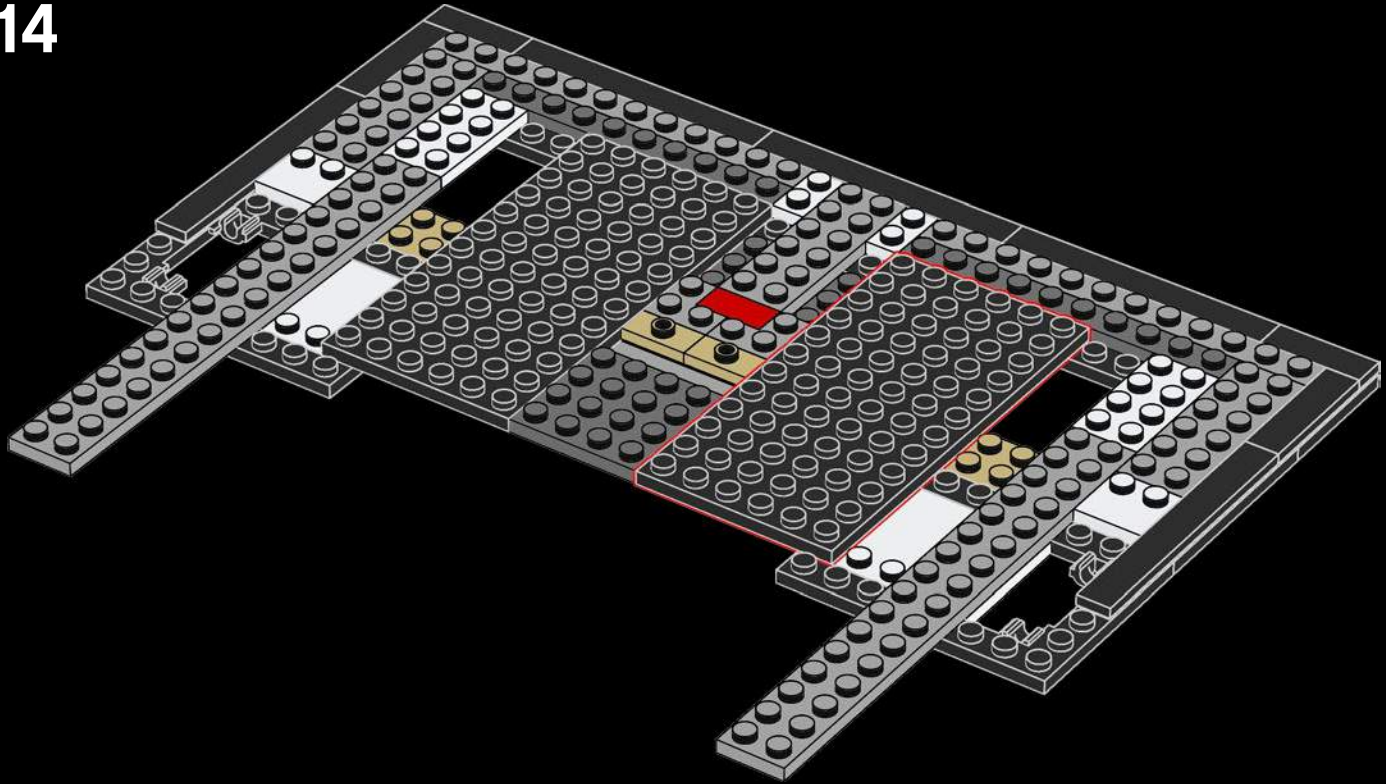





15

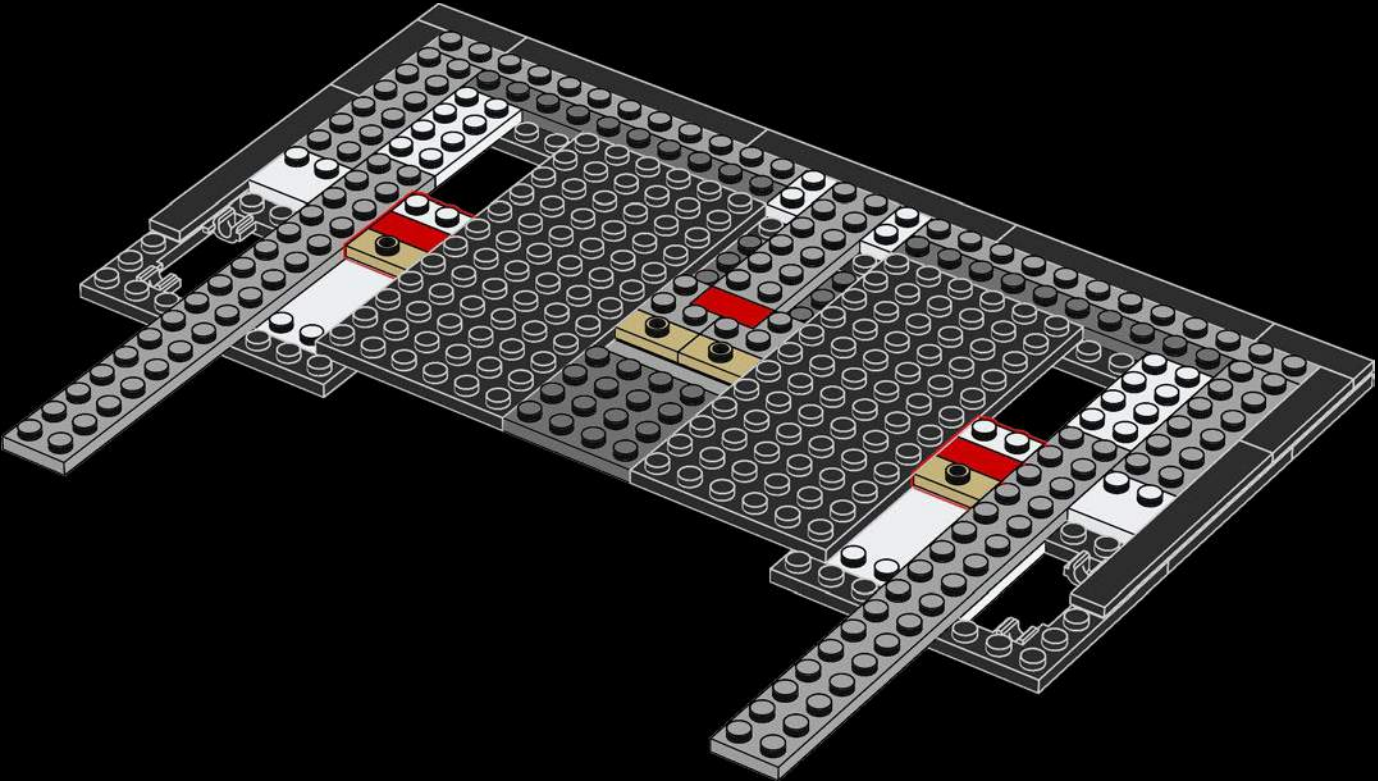

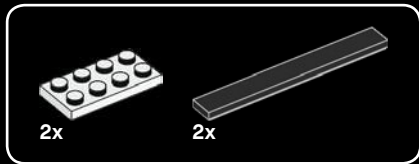

16

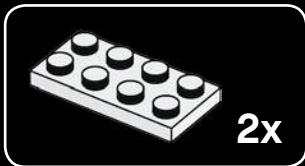
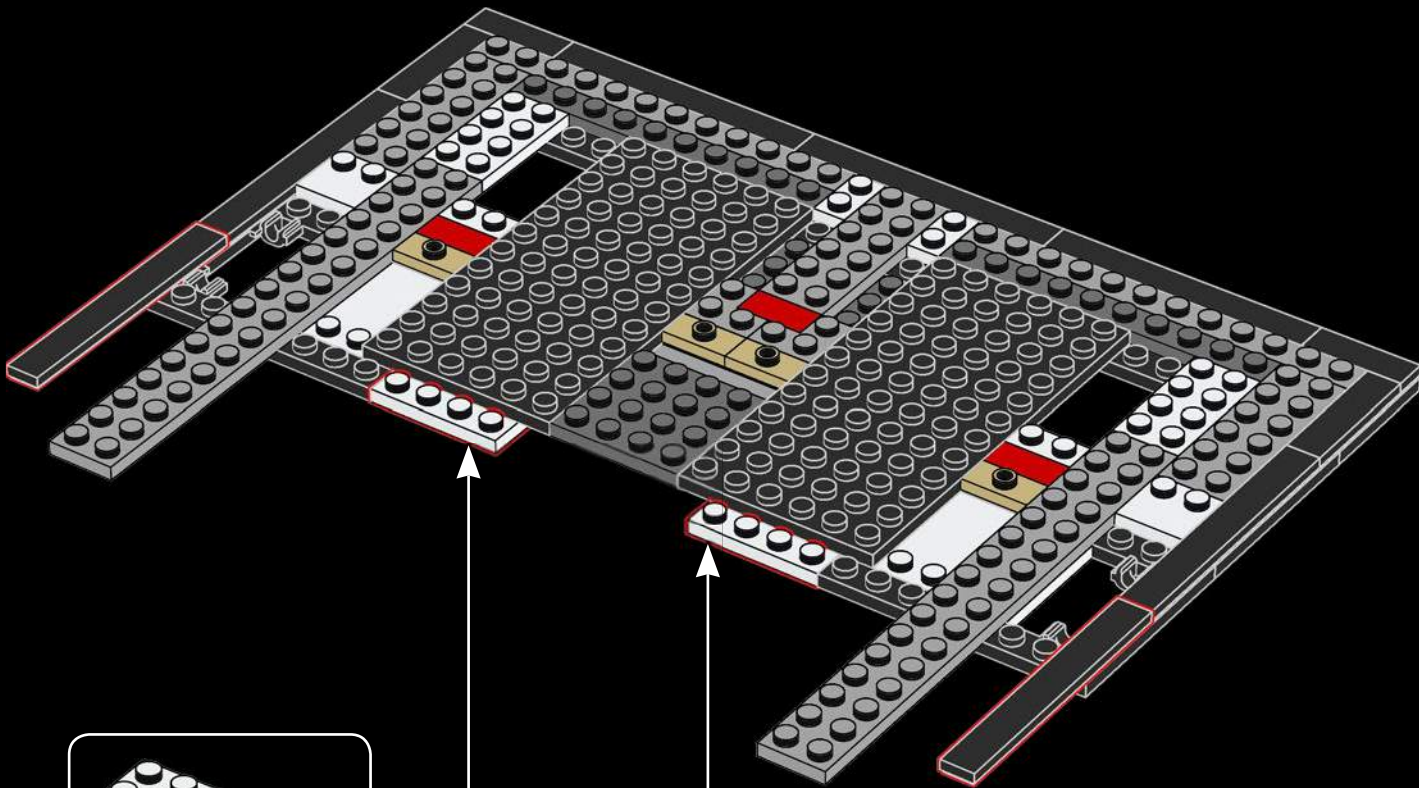

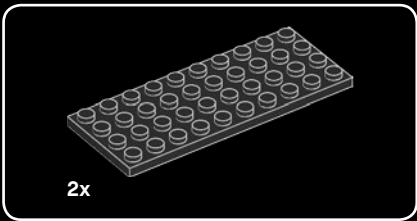

17

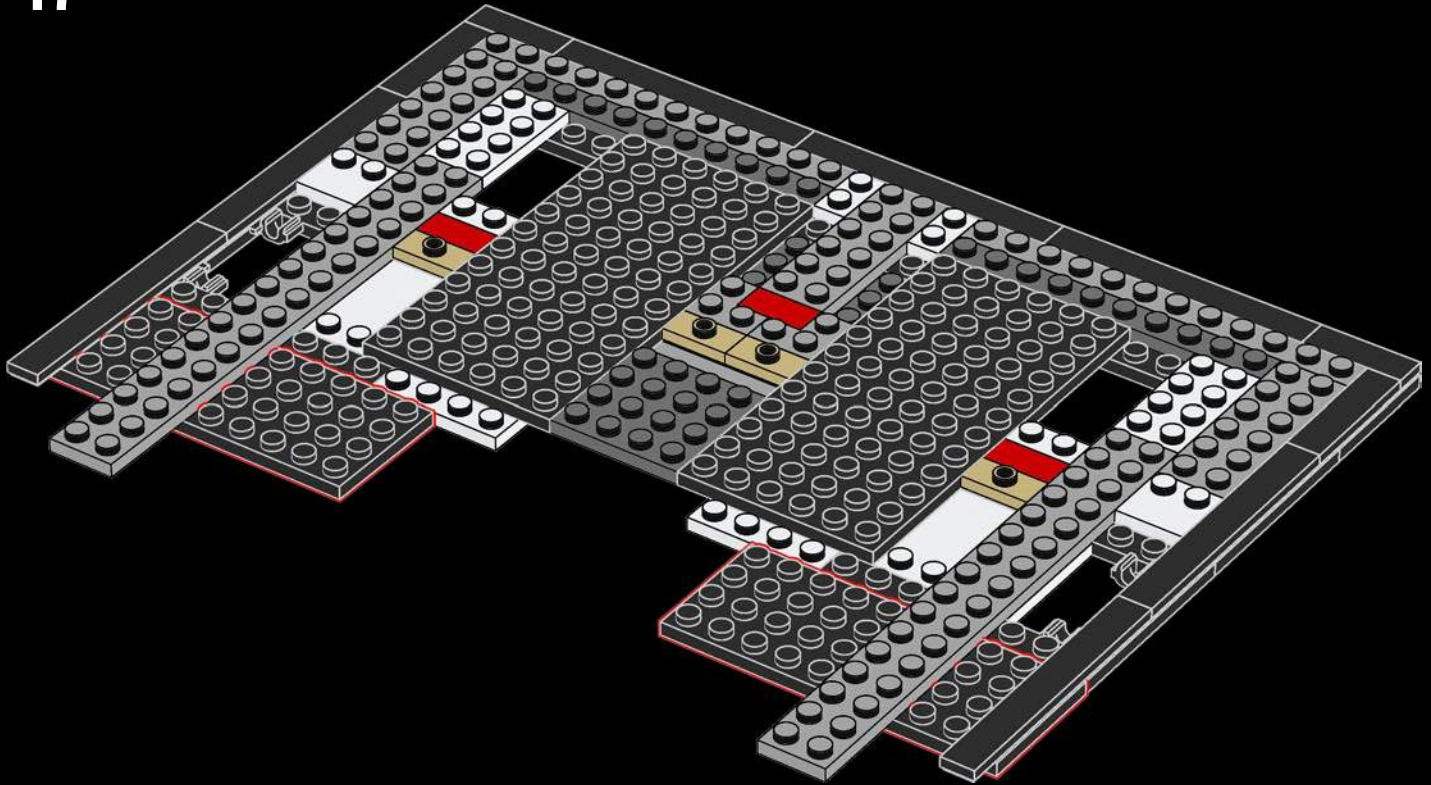

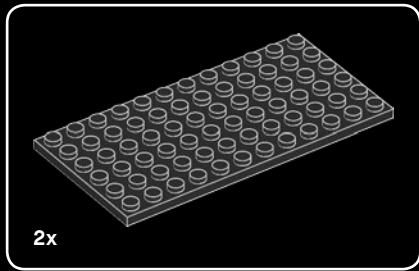

18

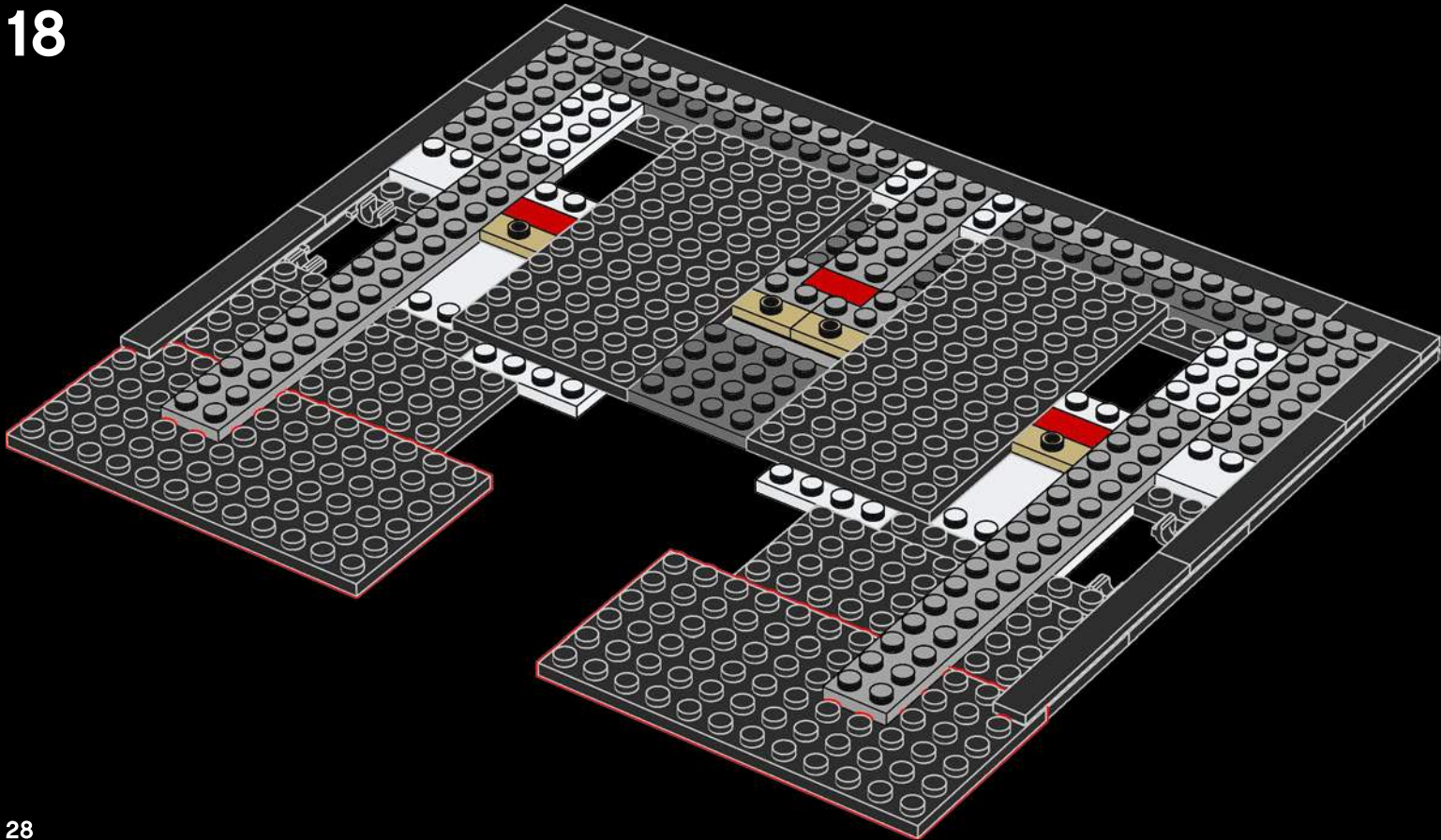

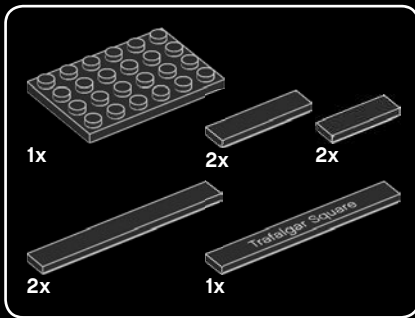

19

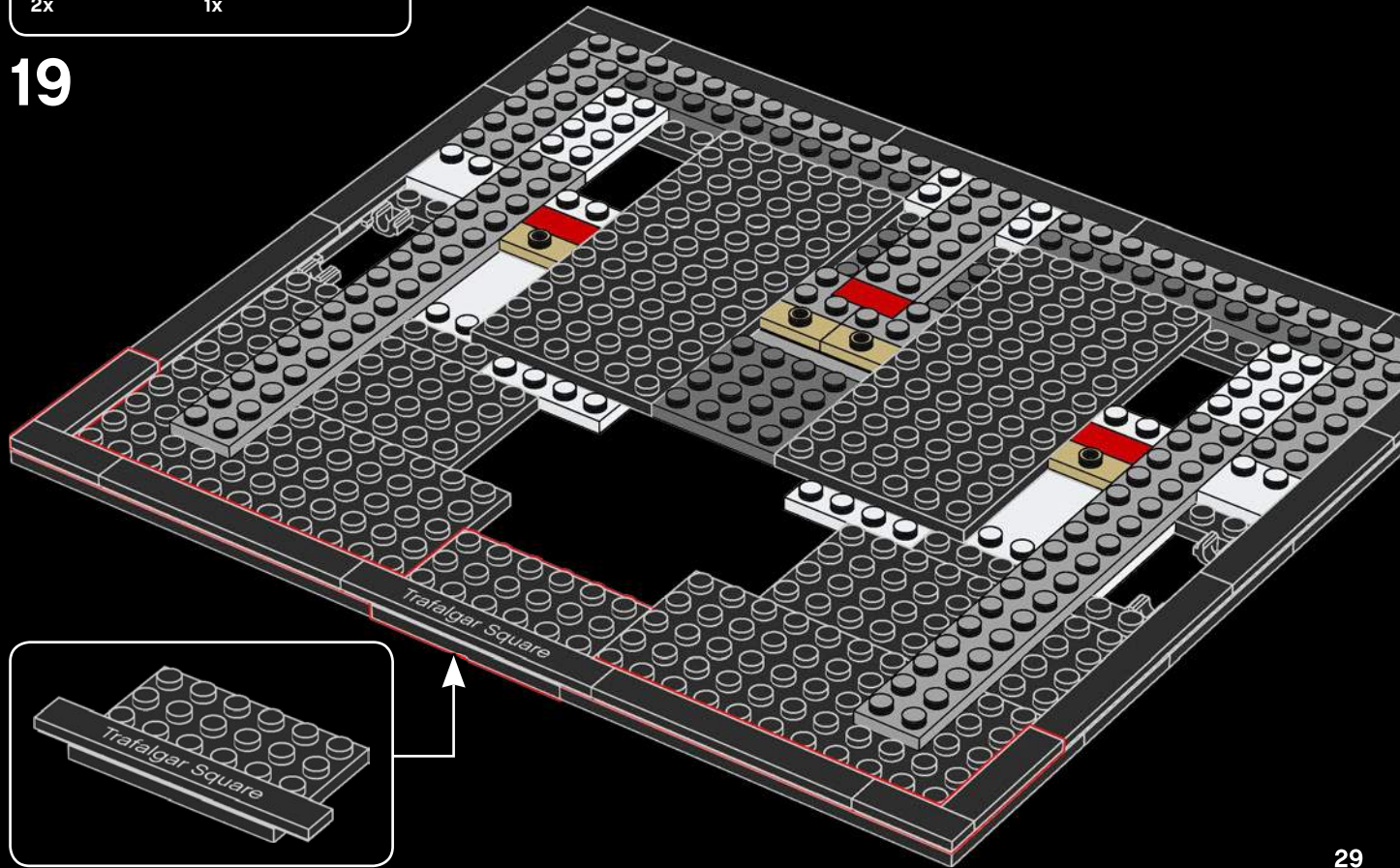

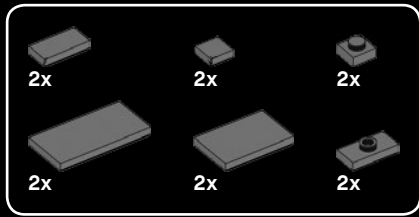

20

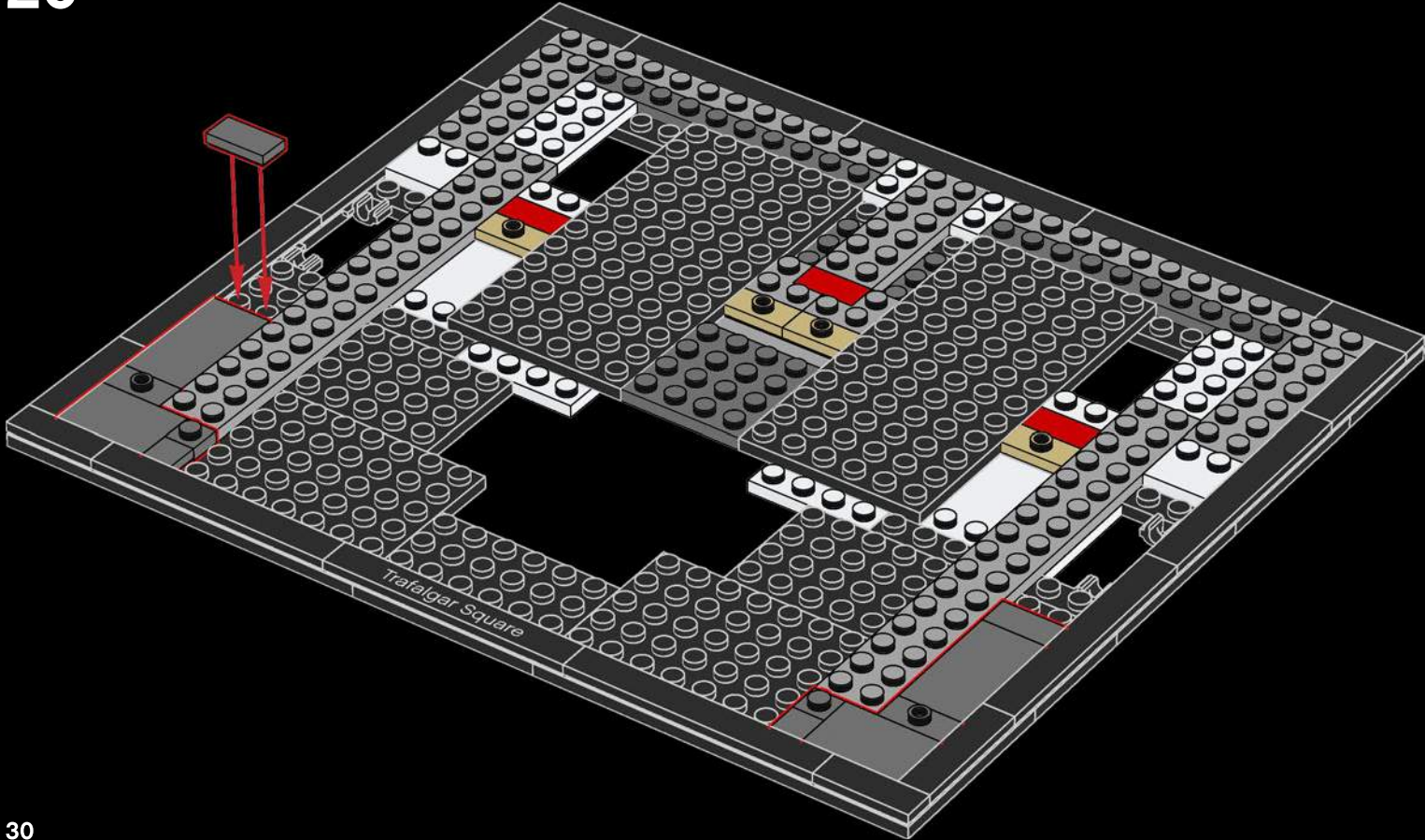

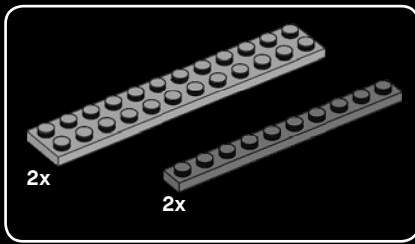

21

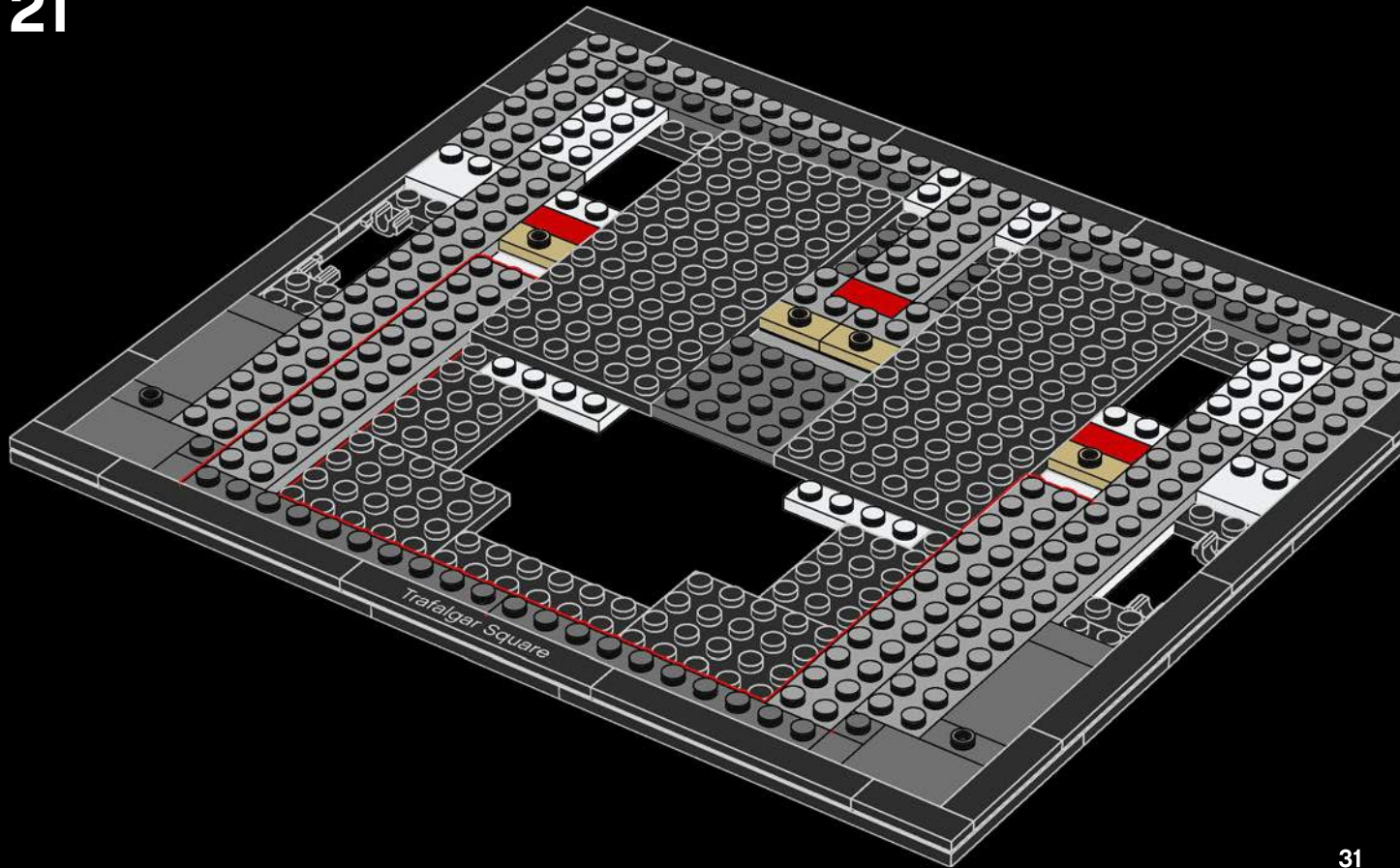

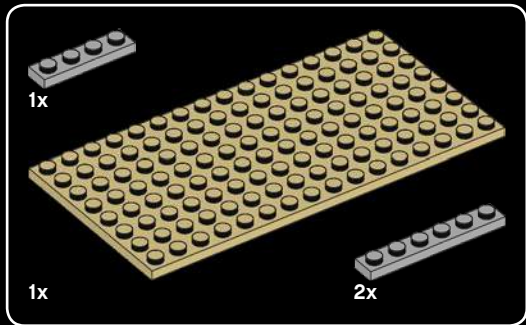

22

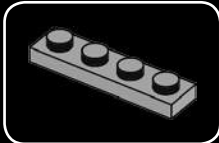
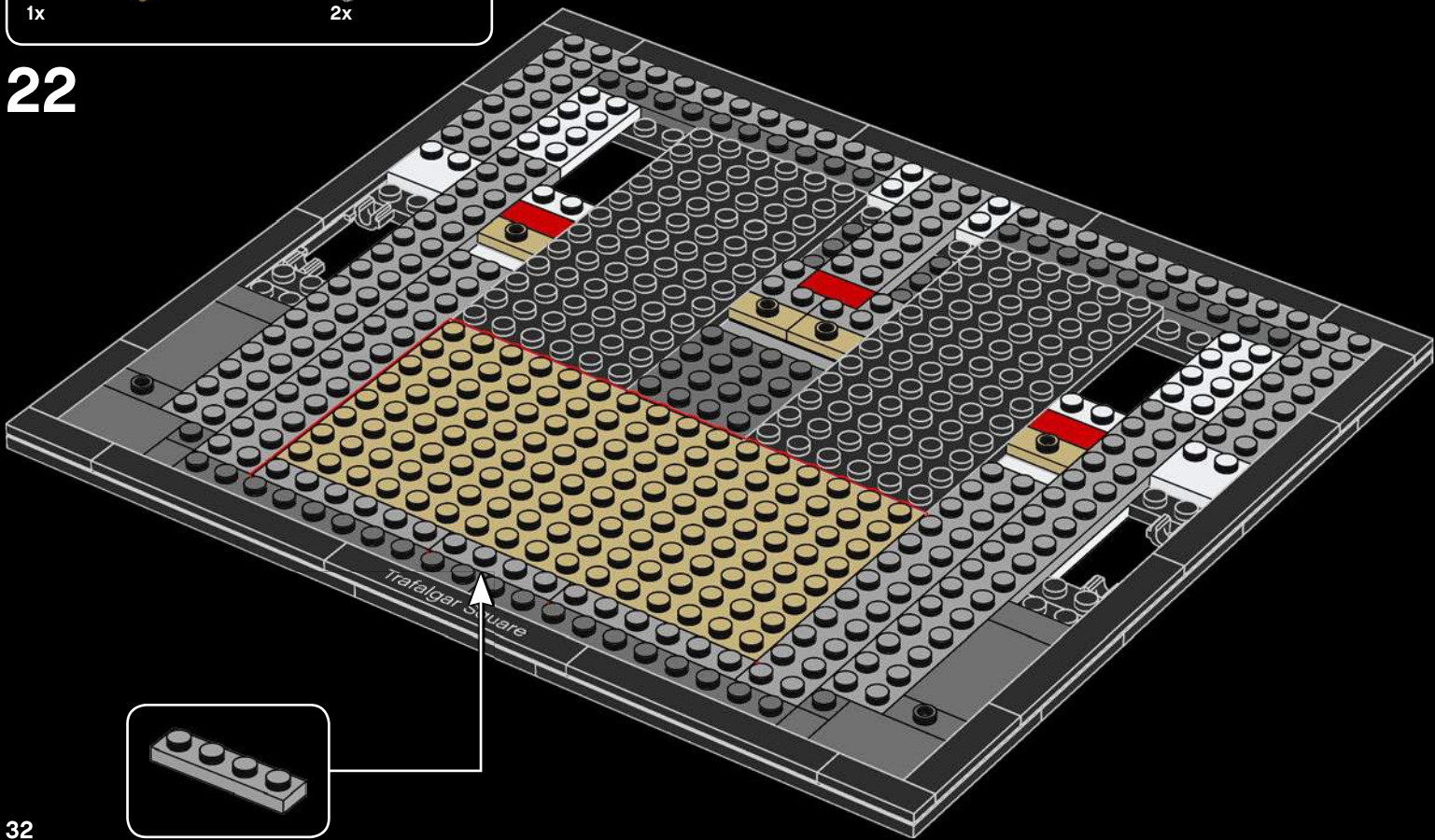



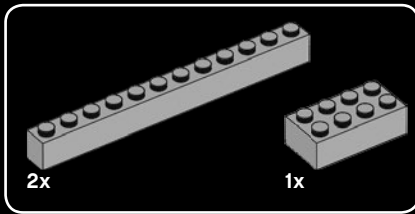

23

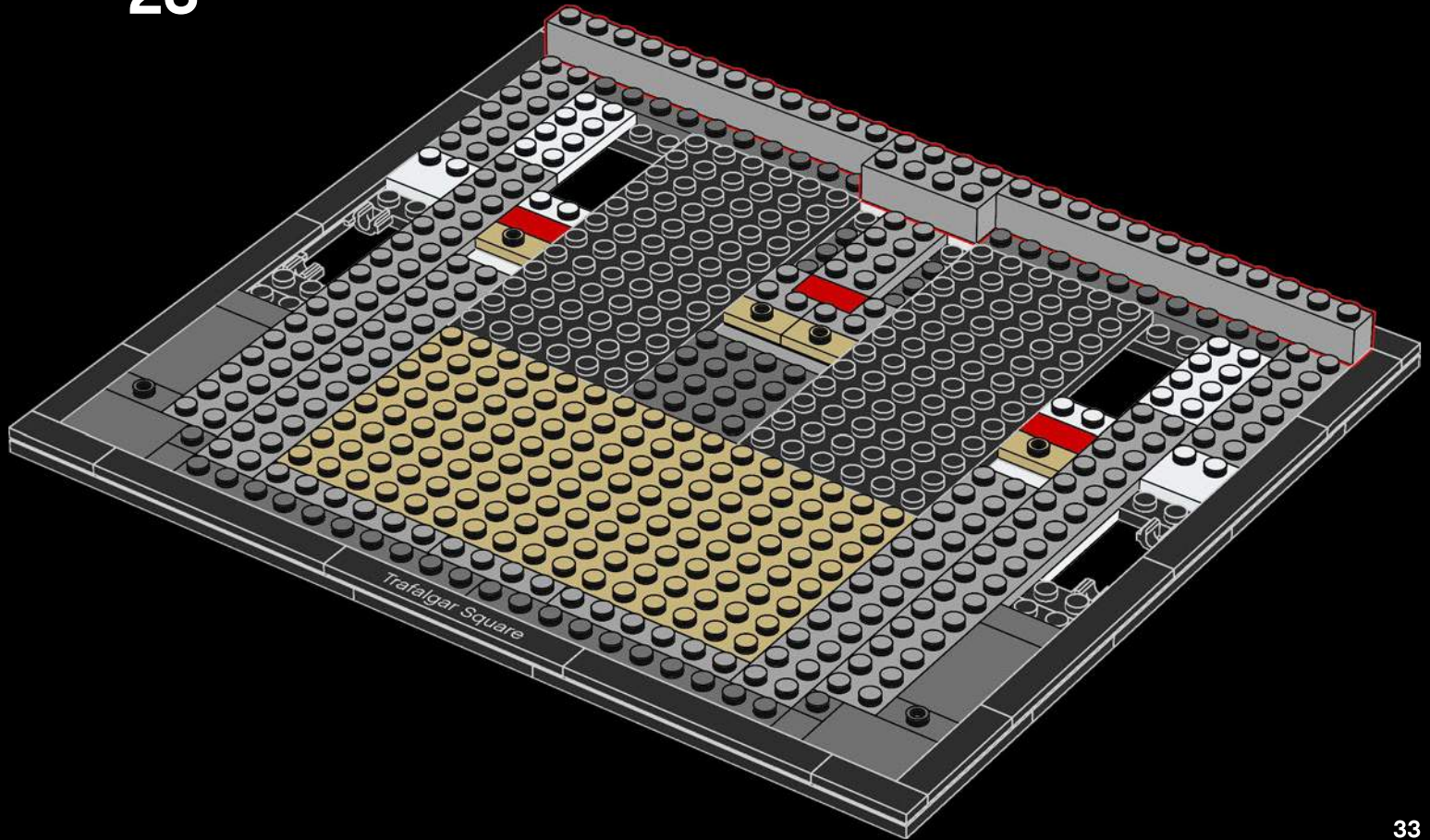

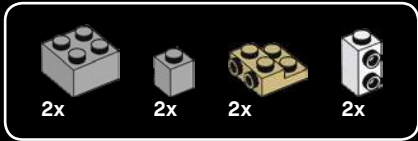

24

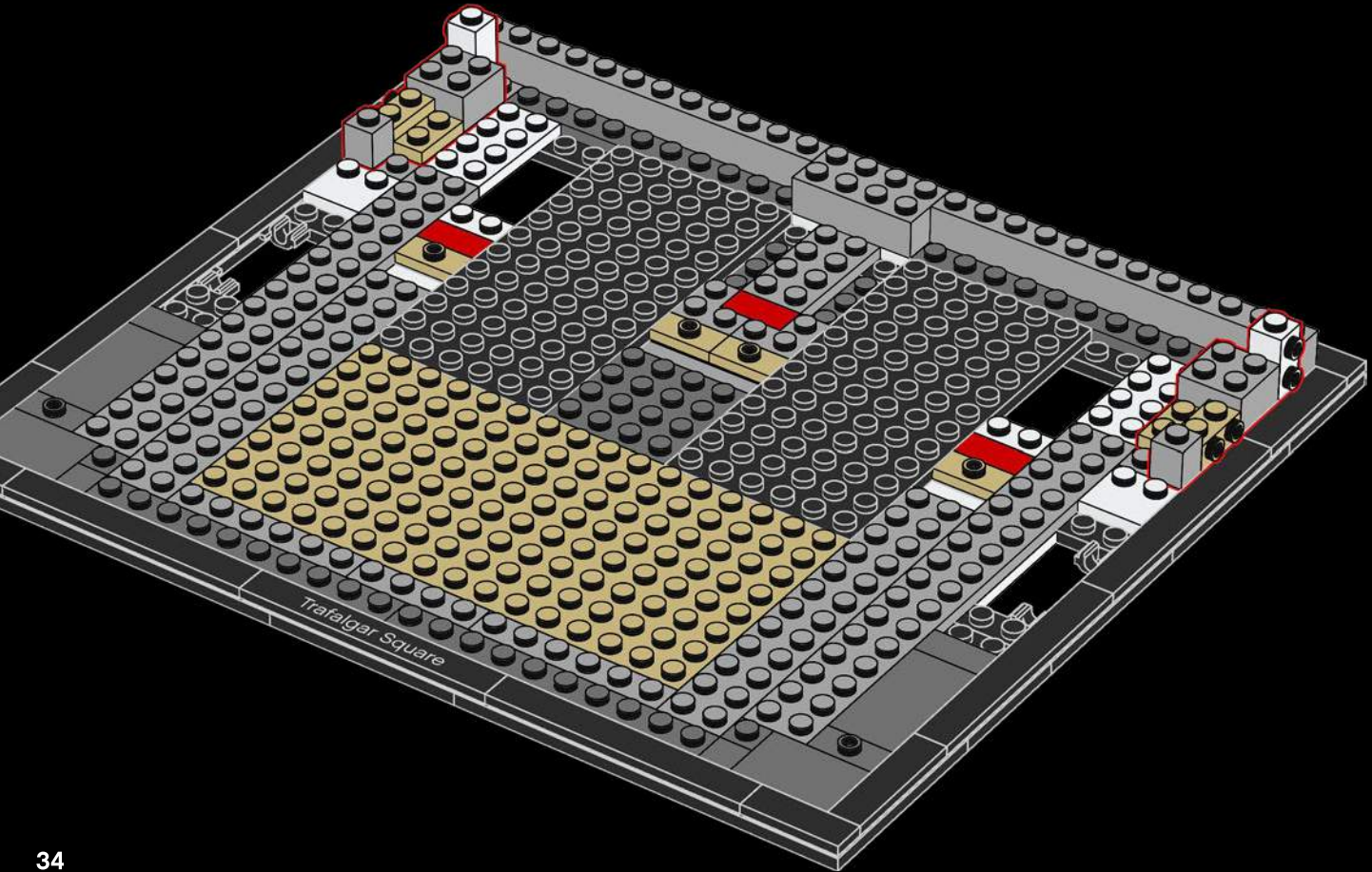



25

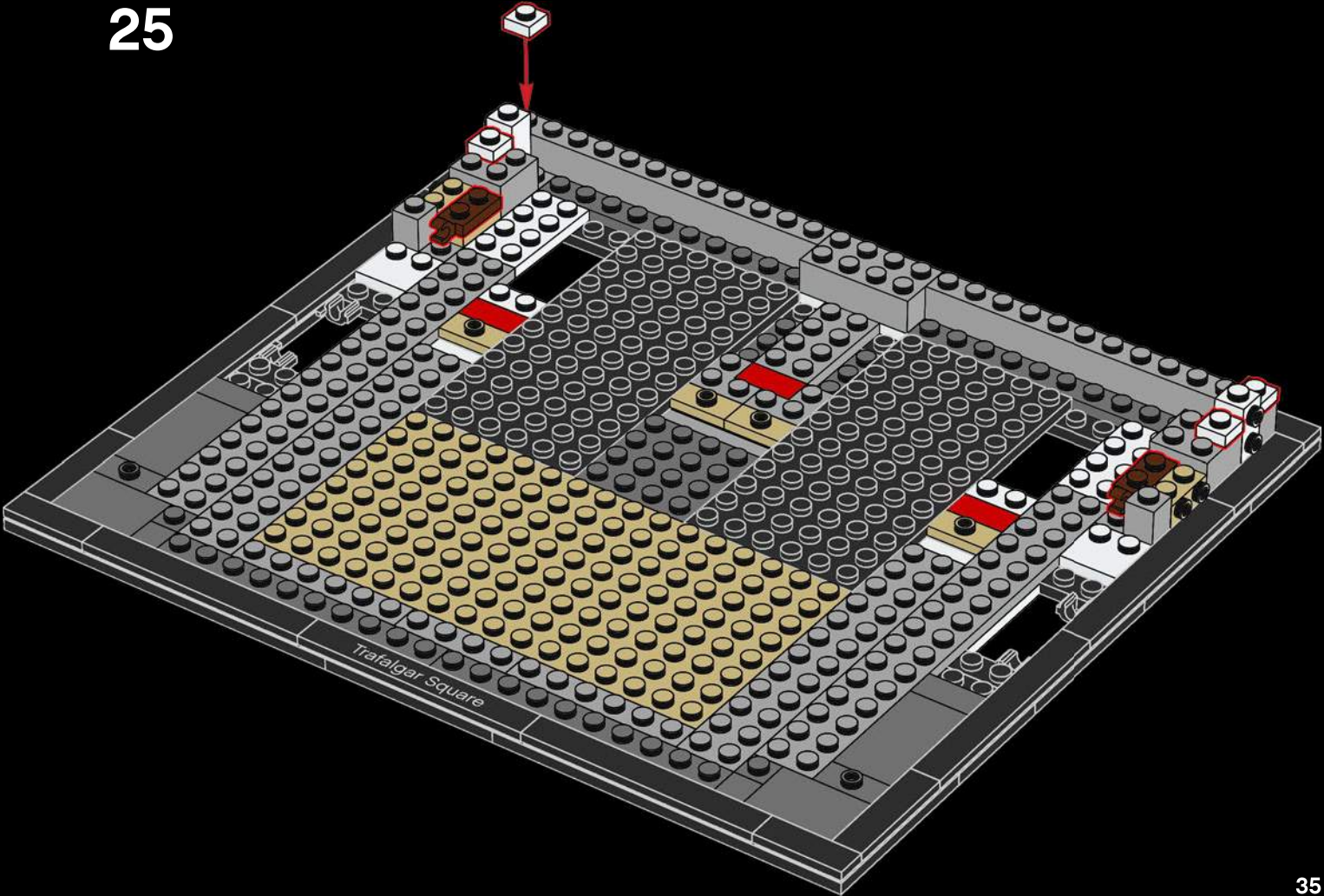



26

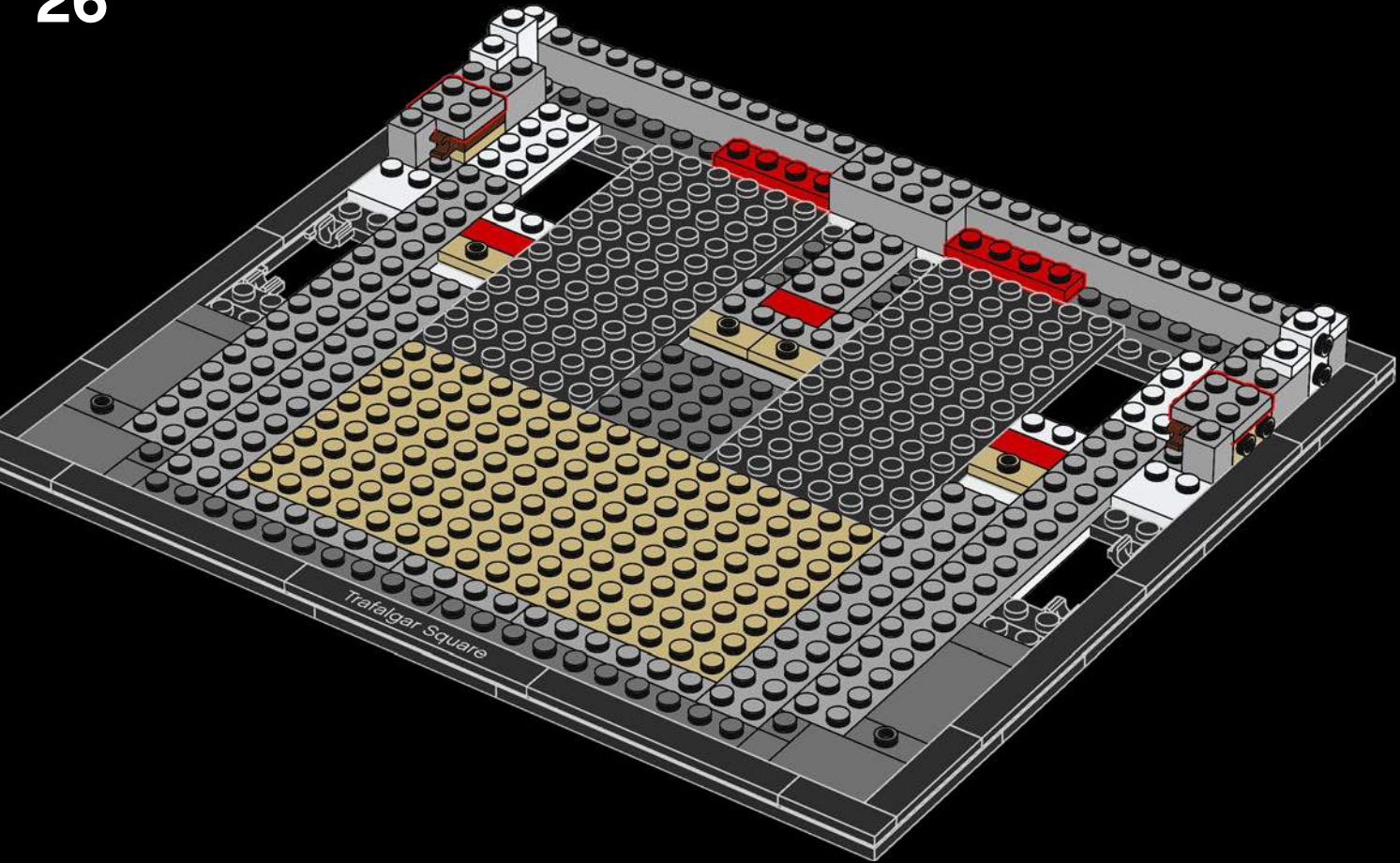

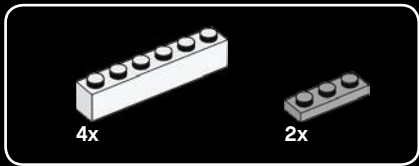

27

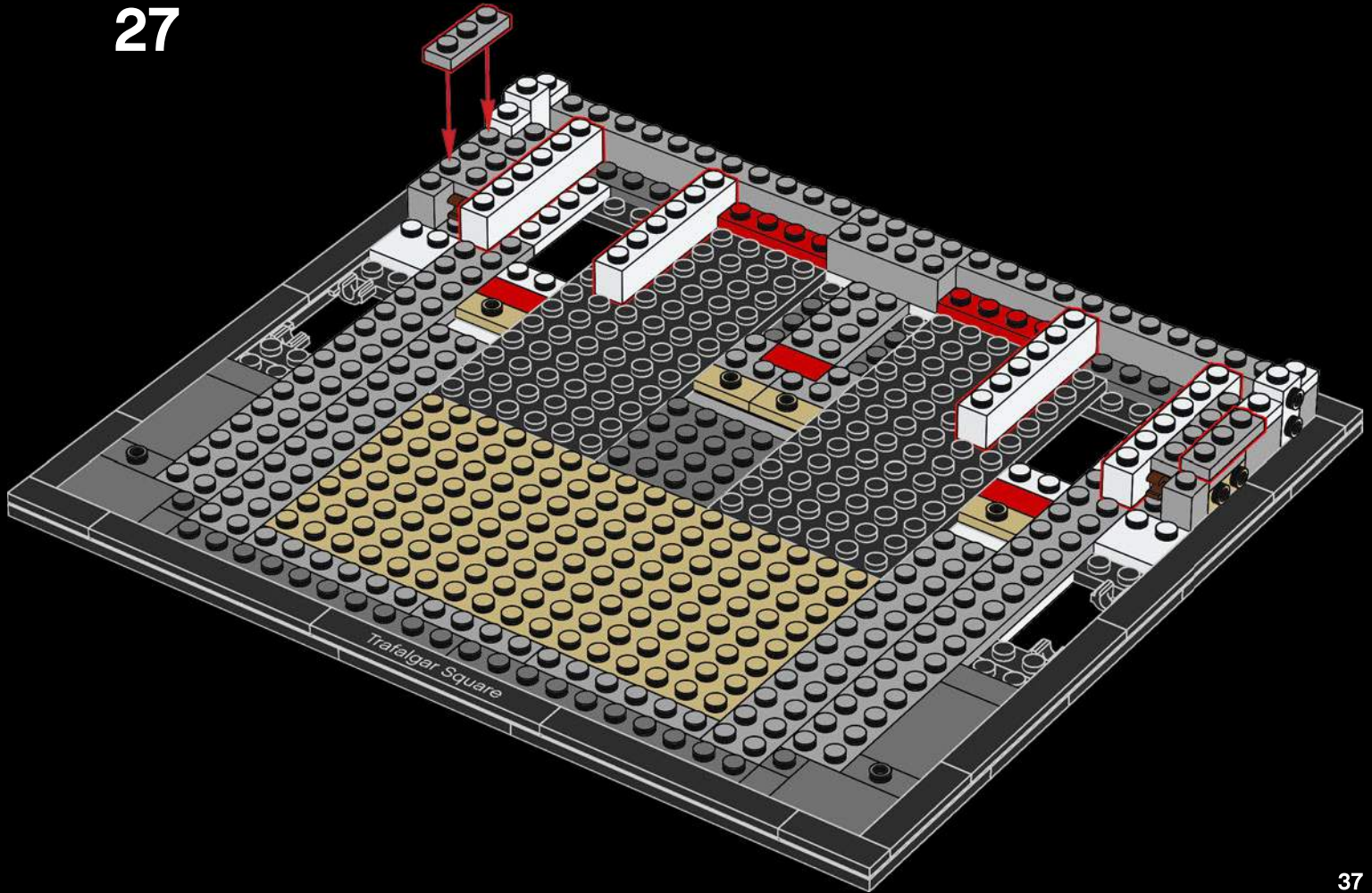

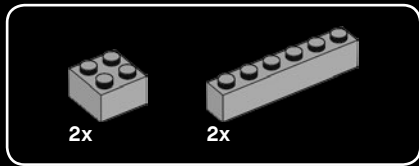

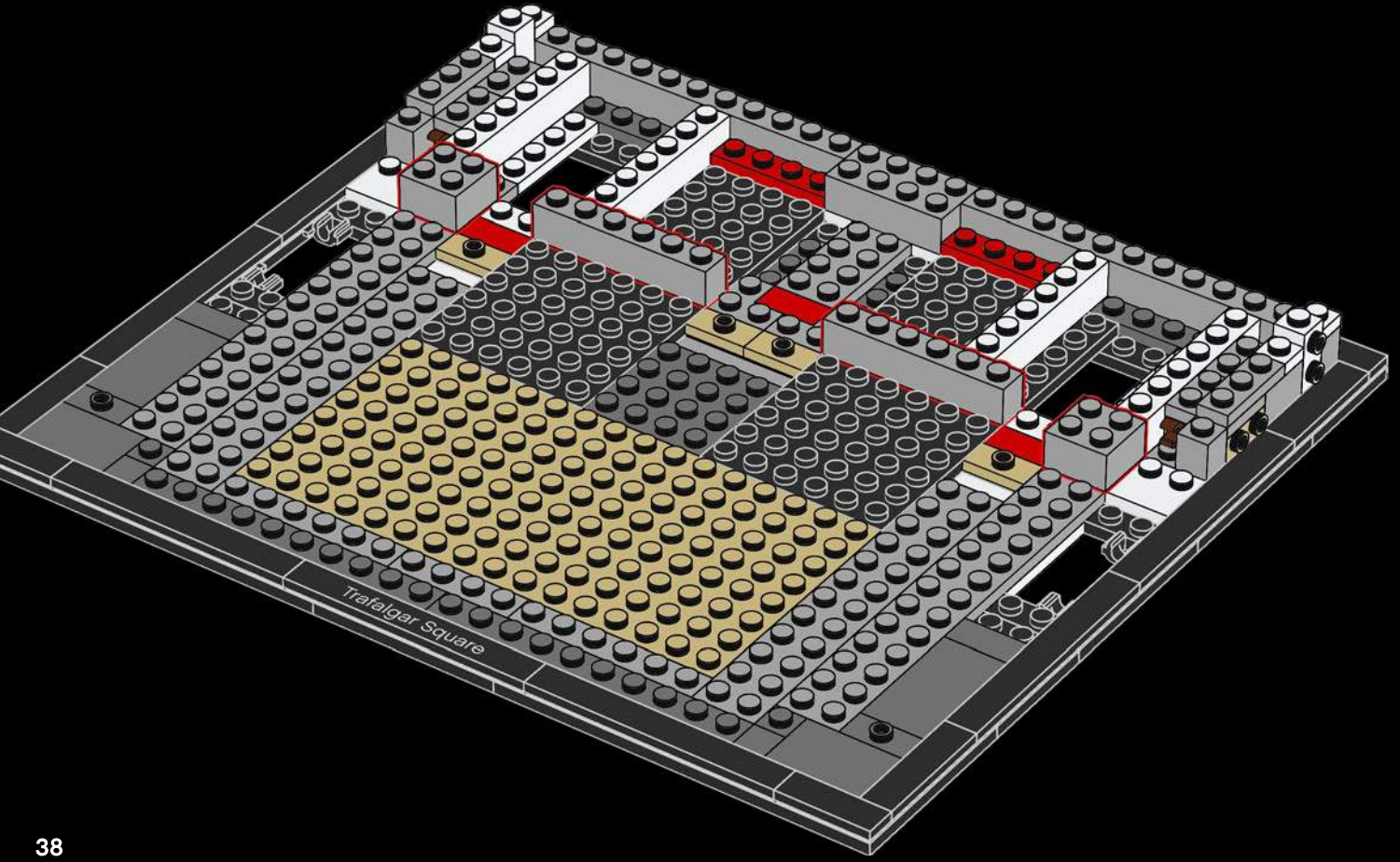

28

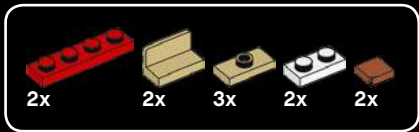

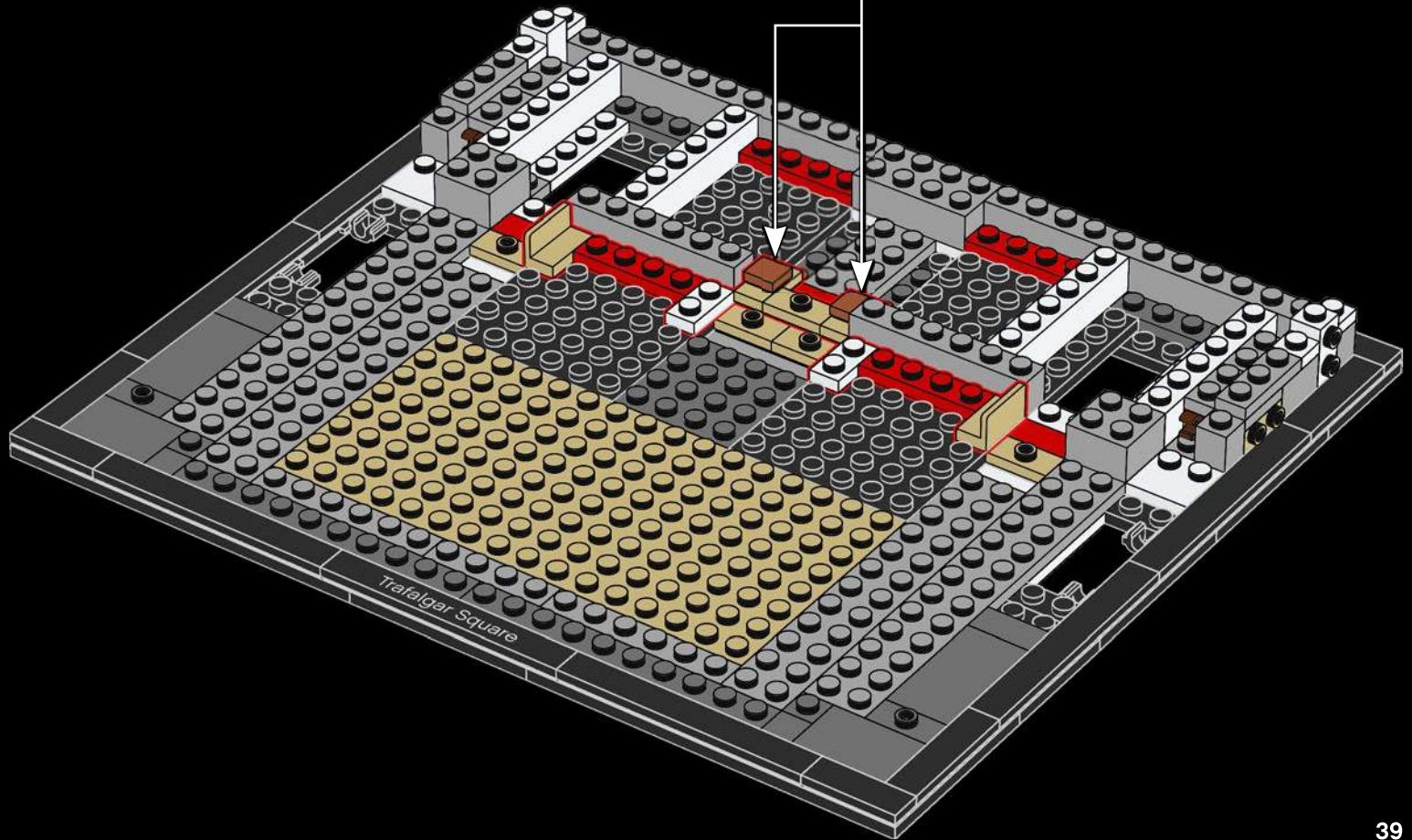
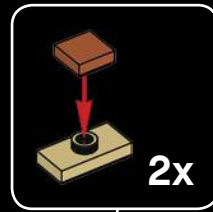

29



6x  2x 

30

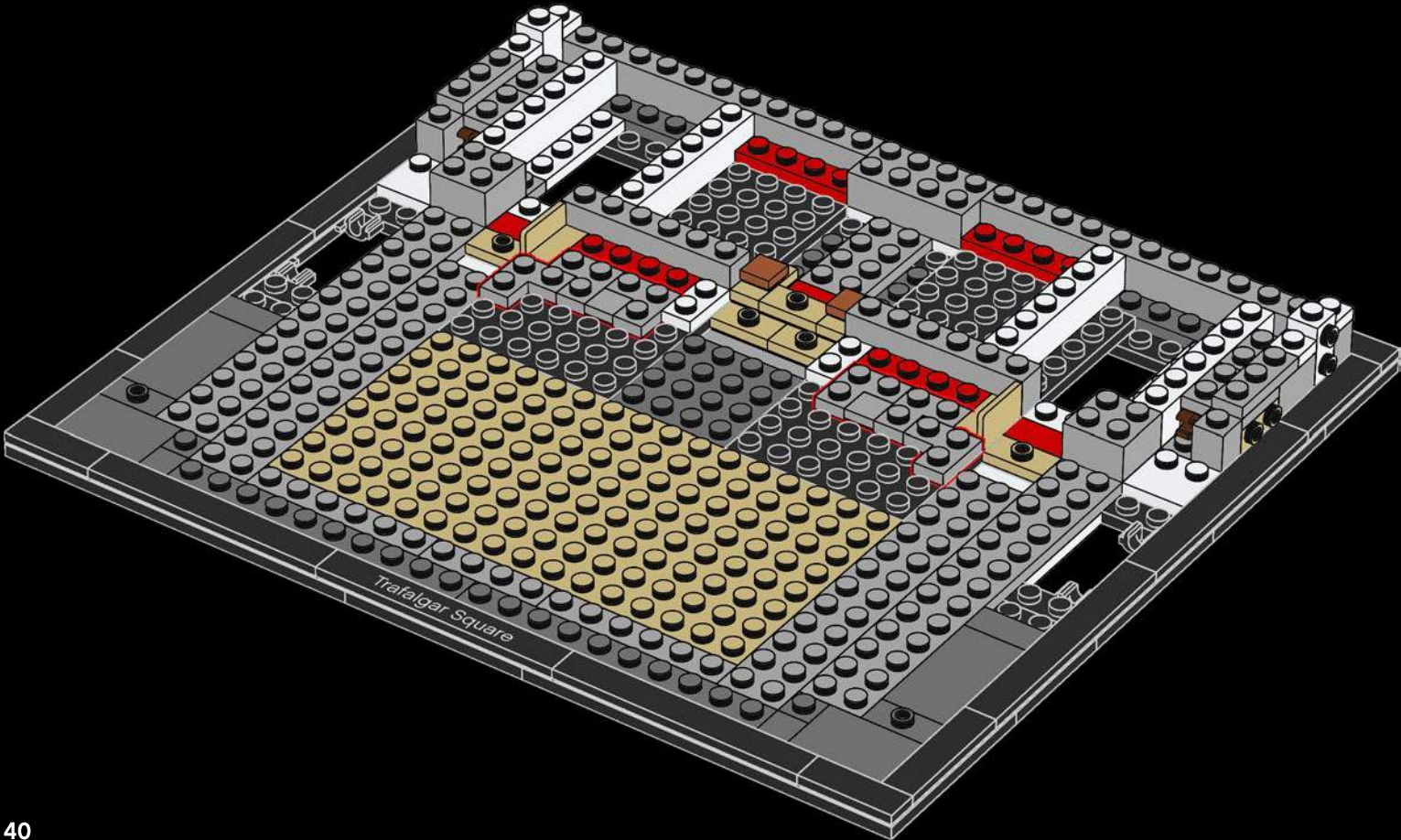

40



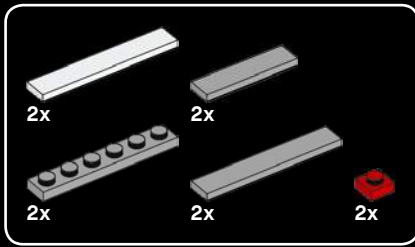

31

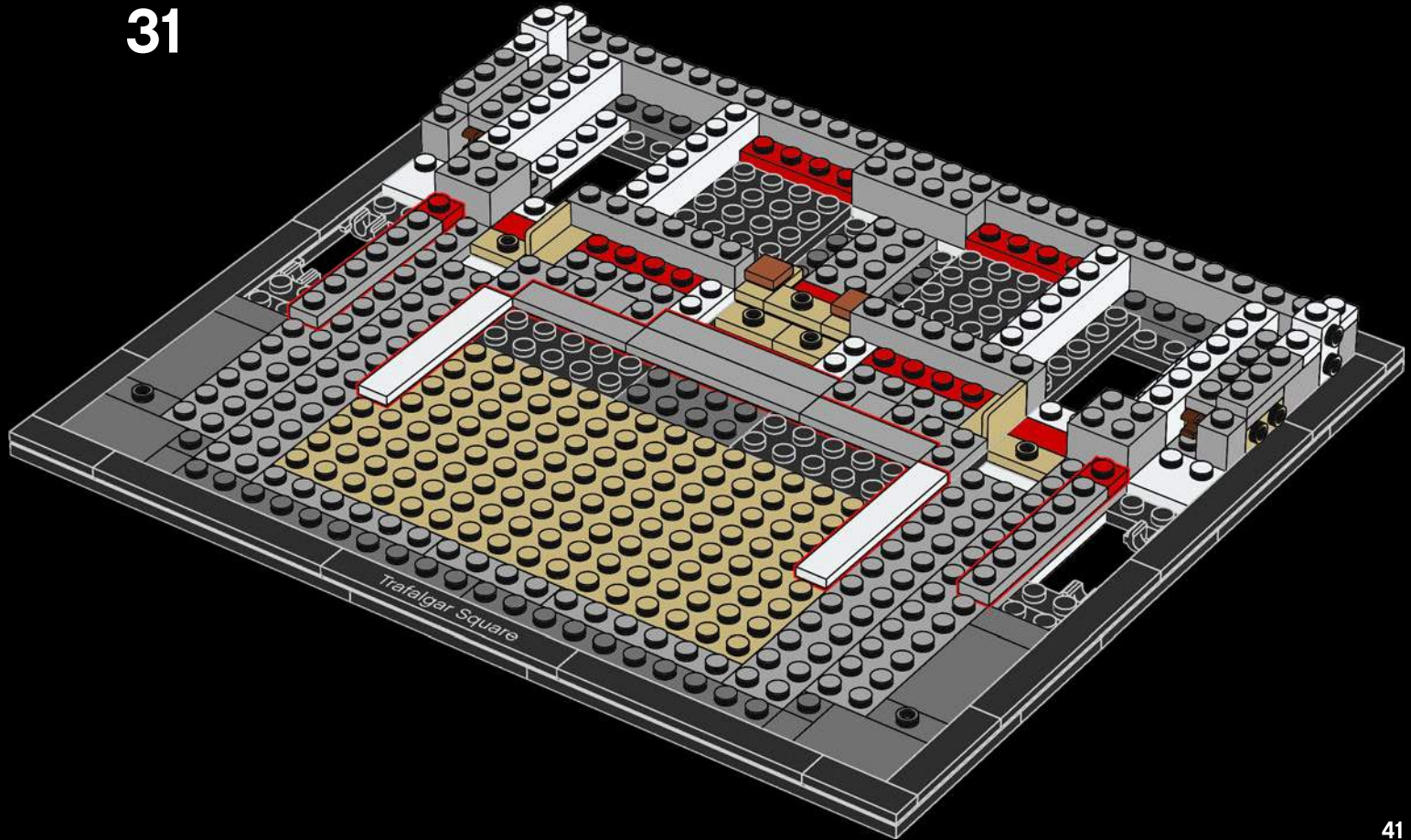



32

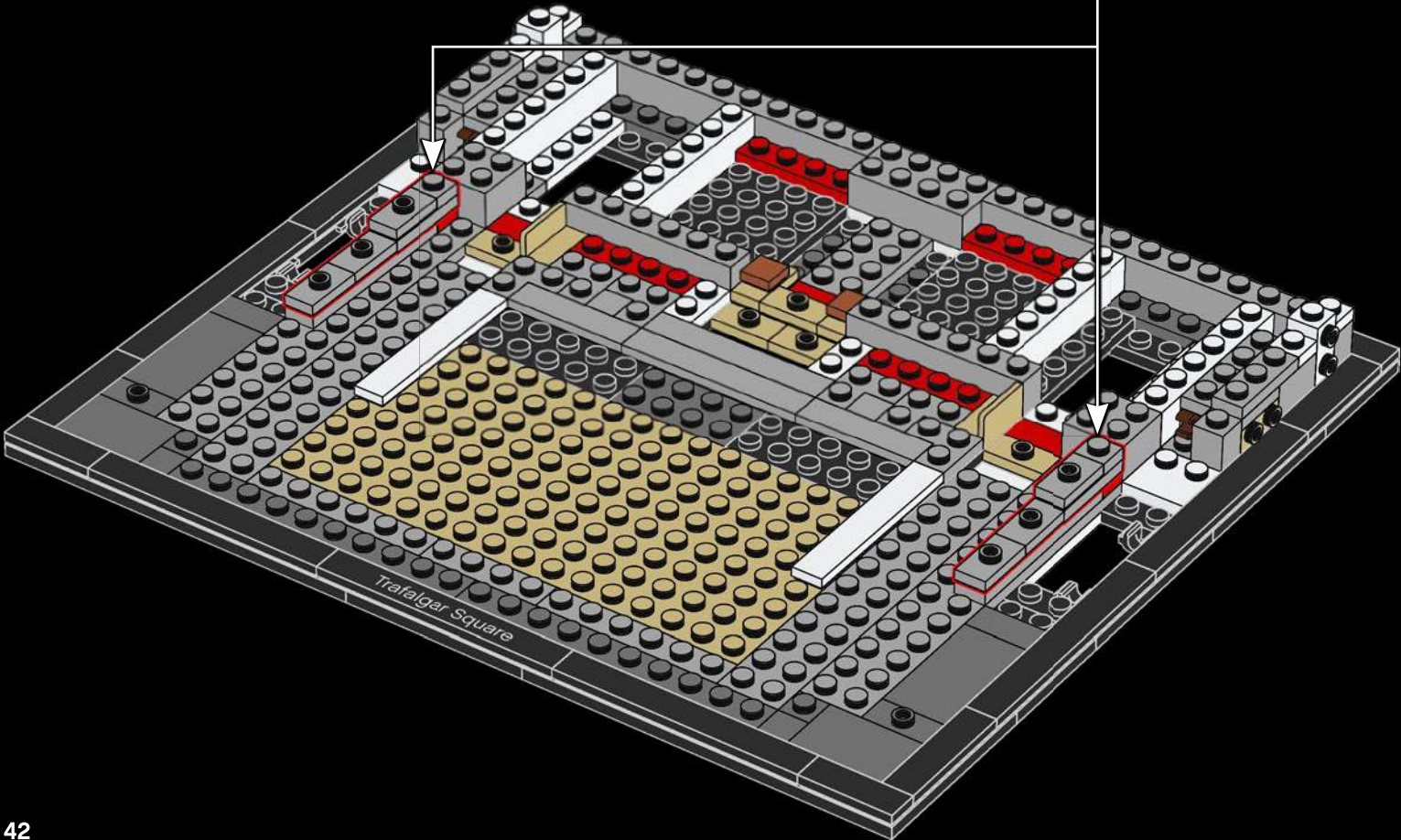
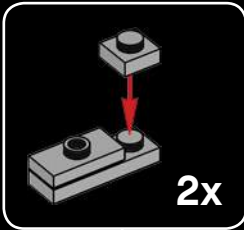

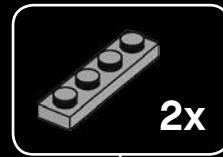
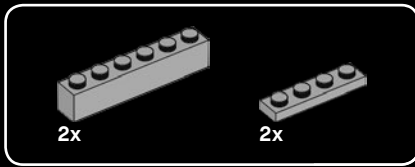

33

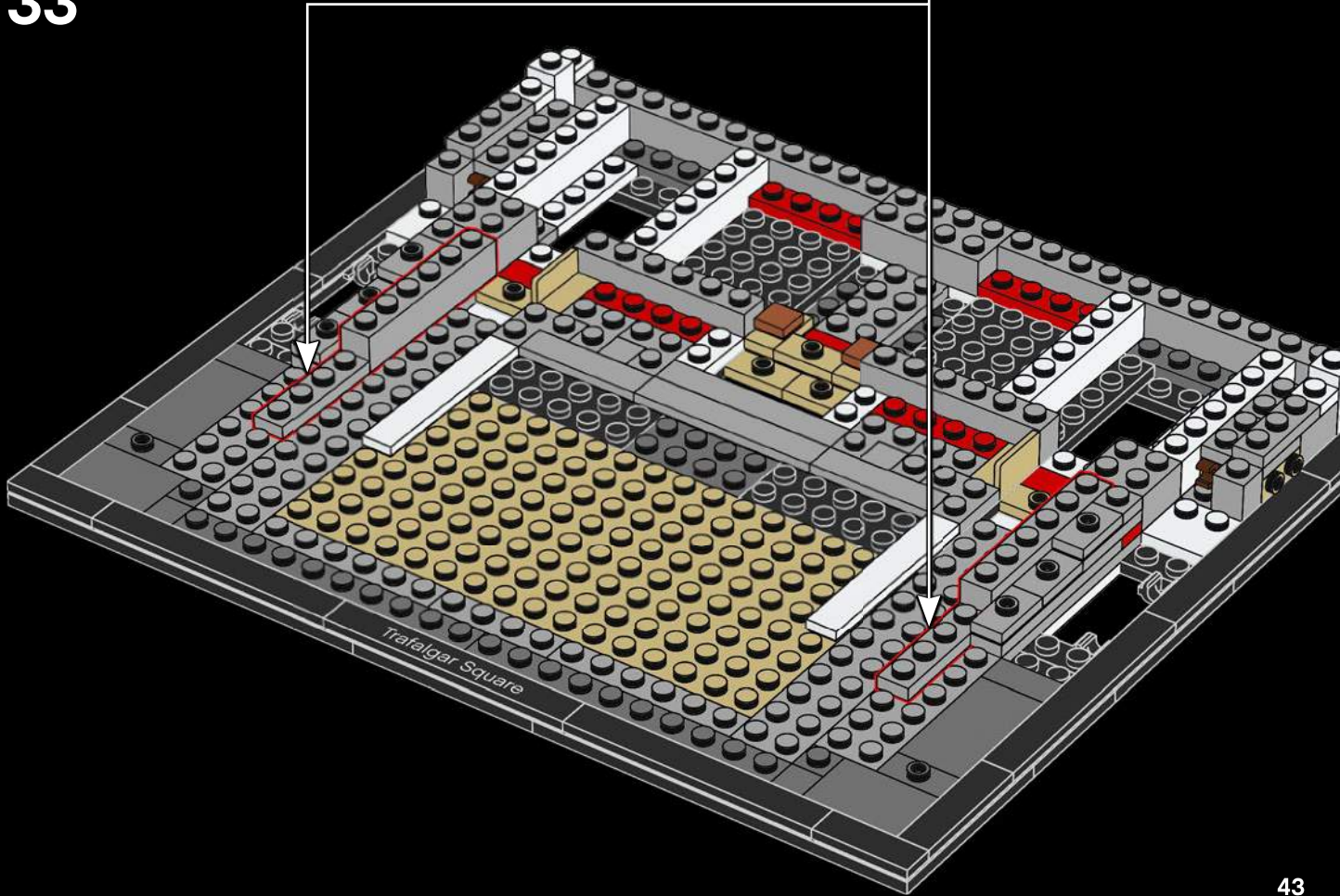

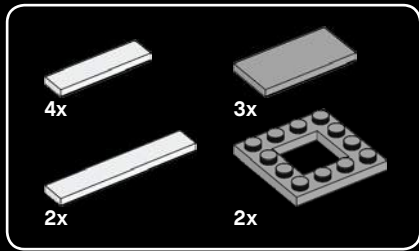

The square was known for the feral pigeons that would congregate in the space. That was until London Mayor Ken Livingstone banned the feeding of them and employed a hawk to keep them away.



# 34

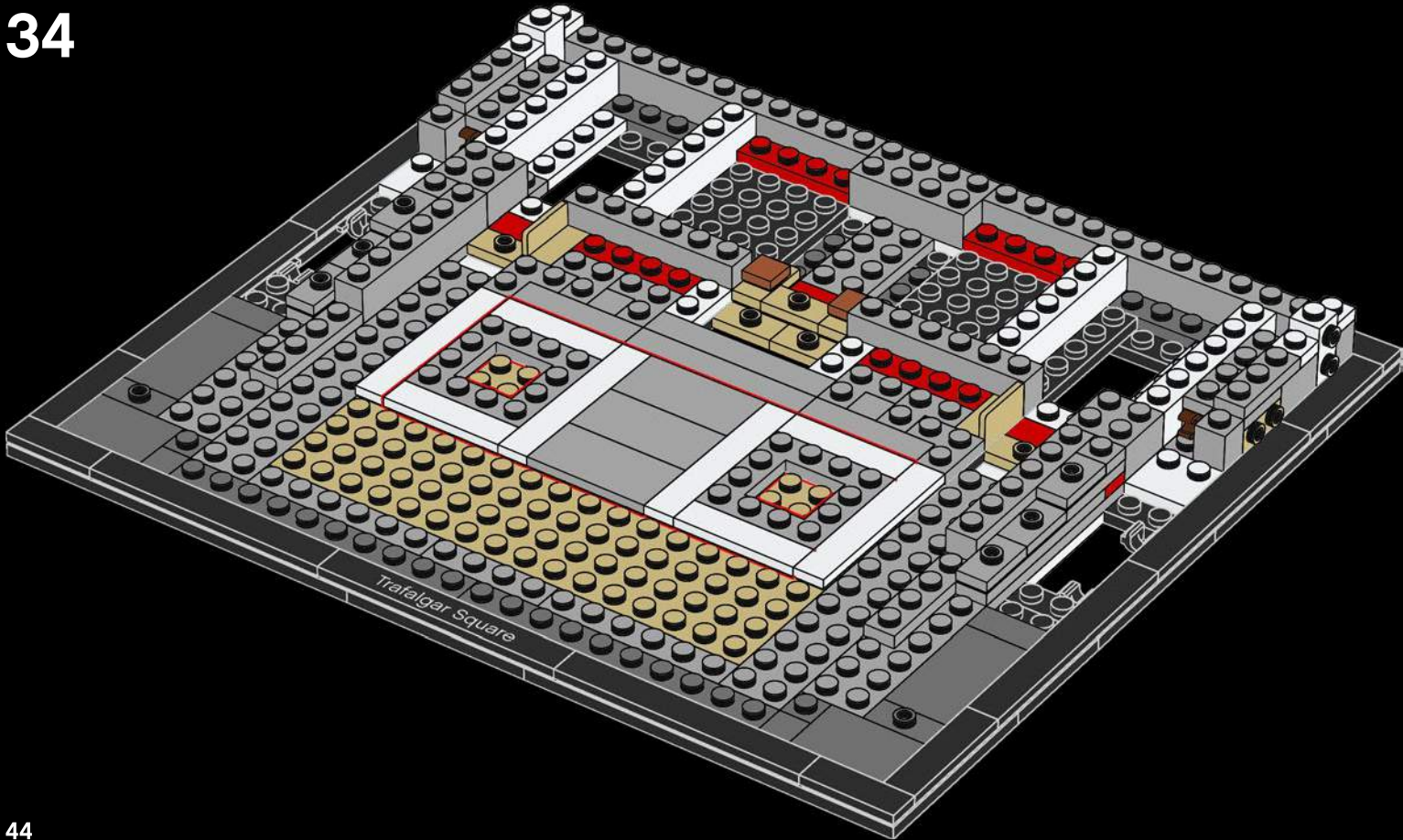

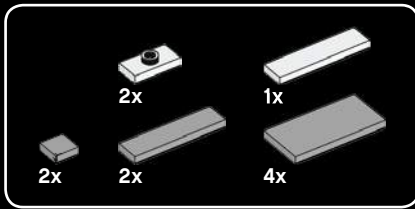

35

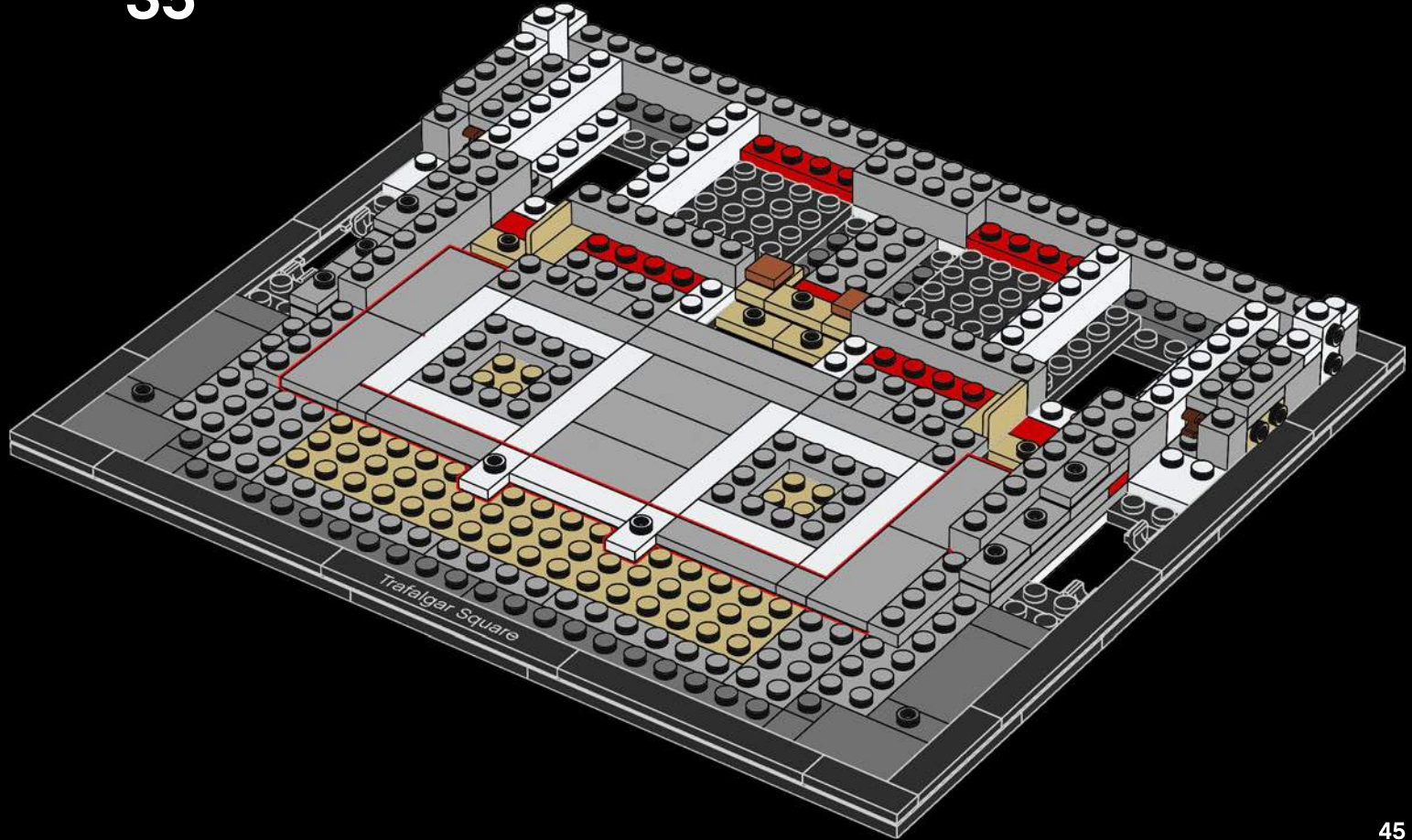

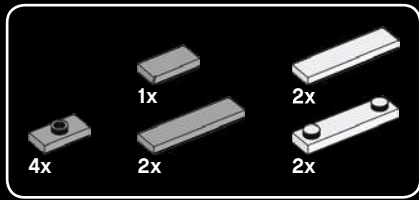

36

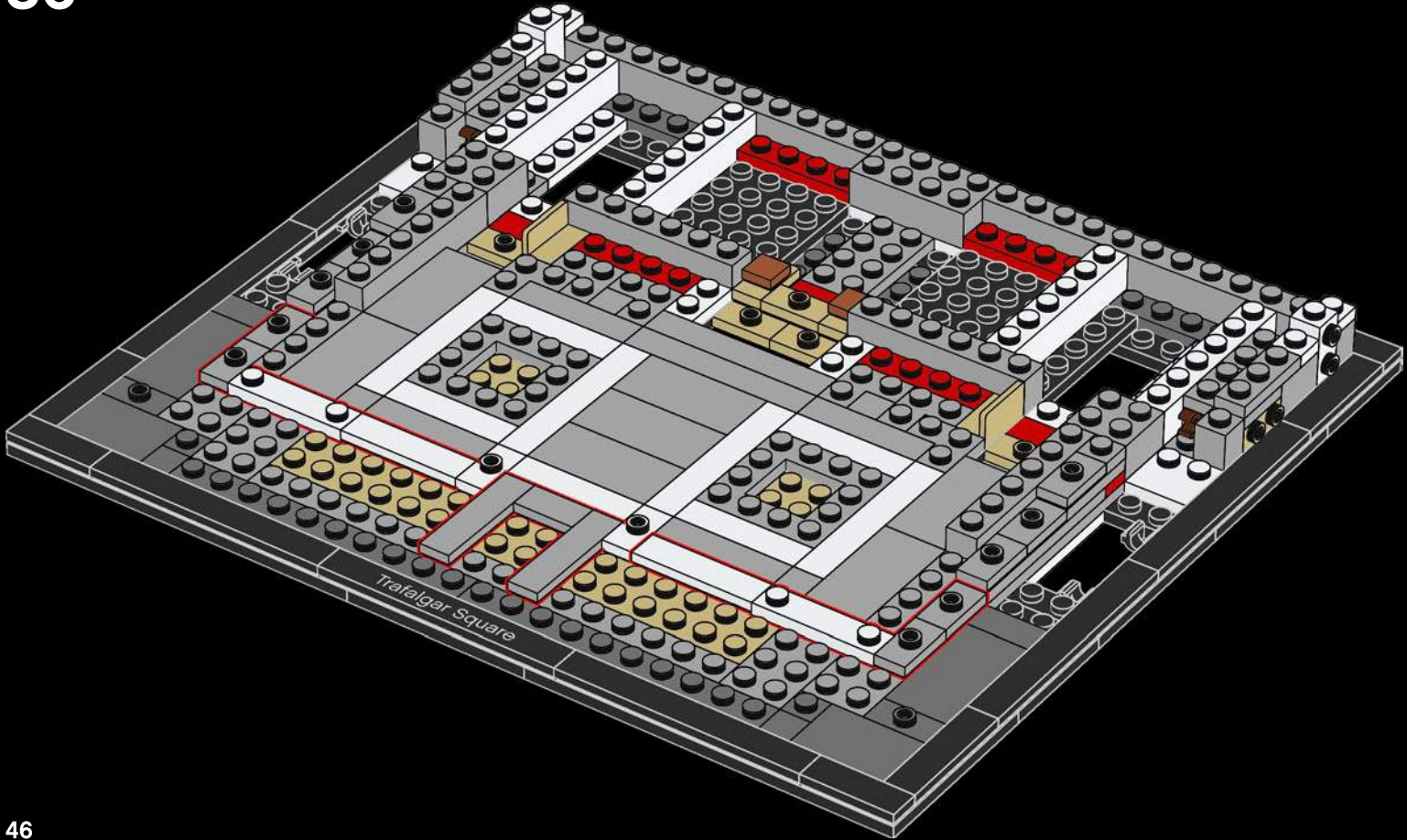

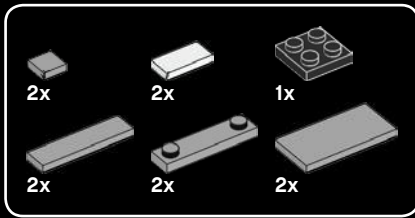

37

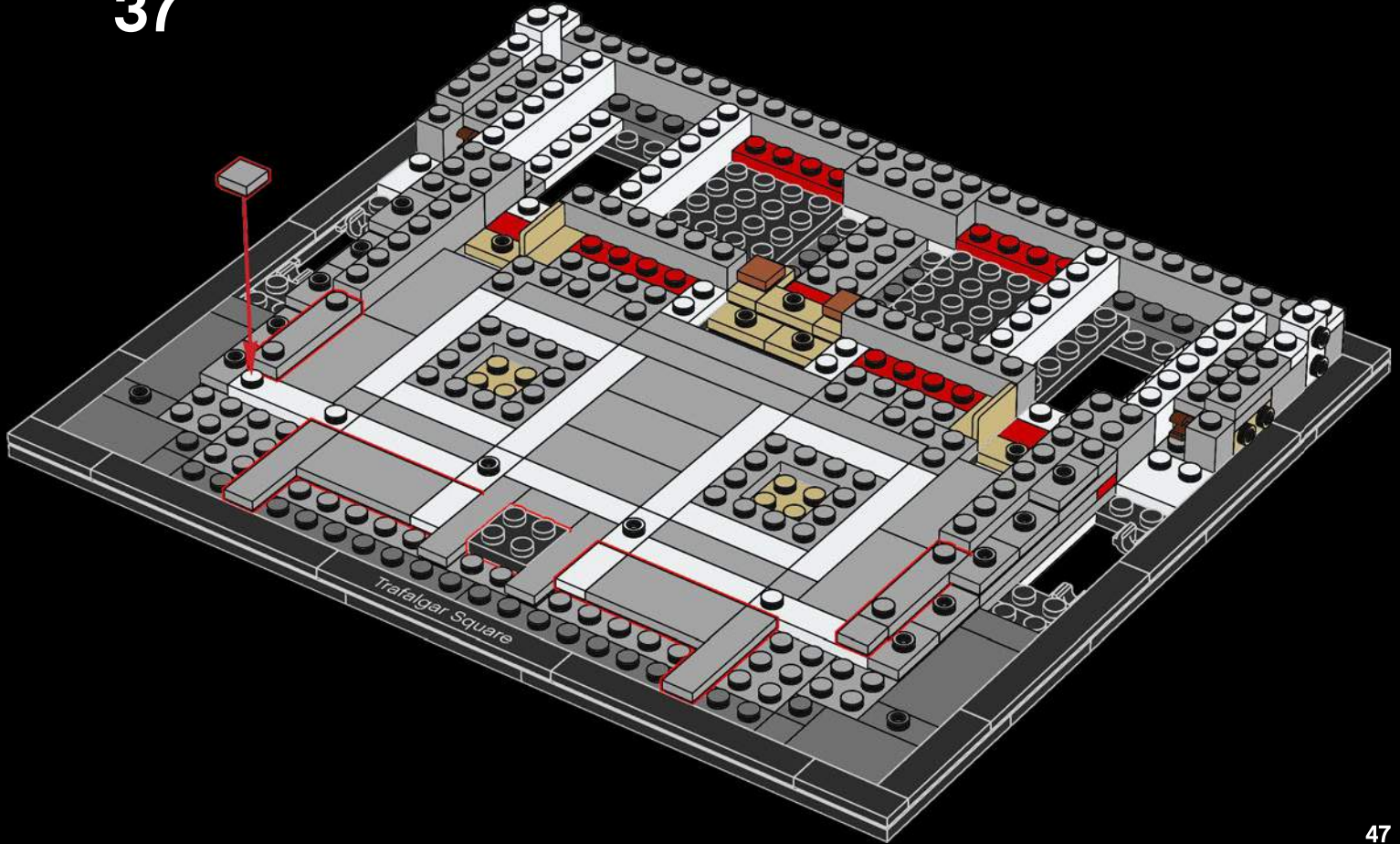

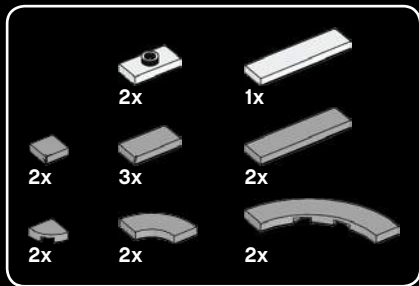

38

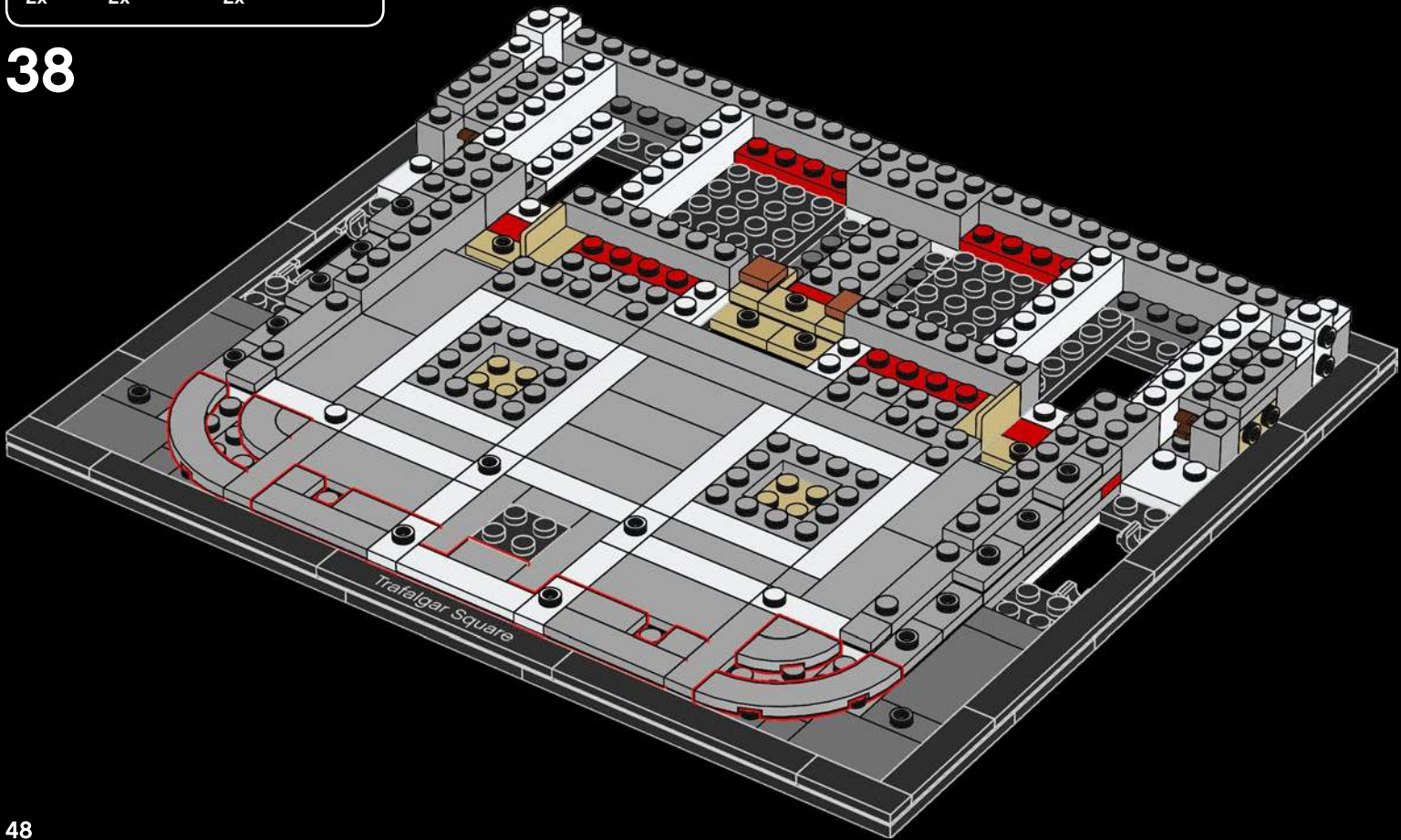





39

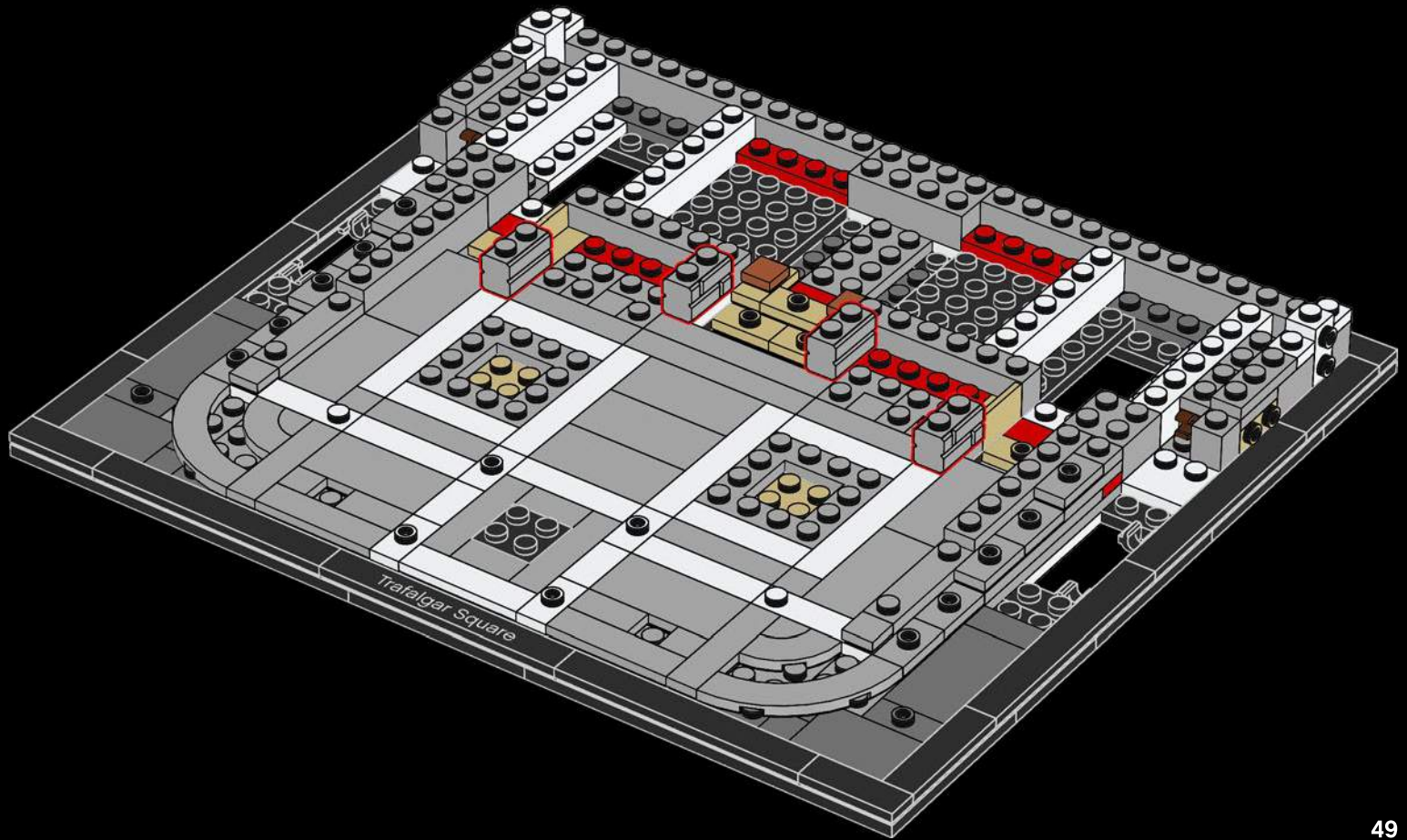

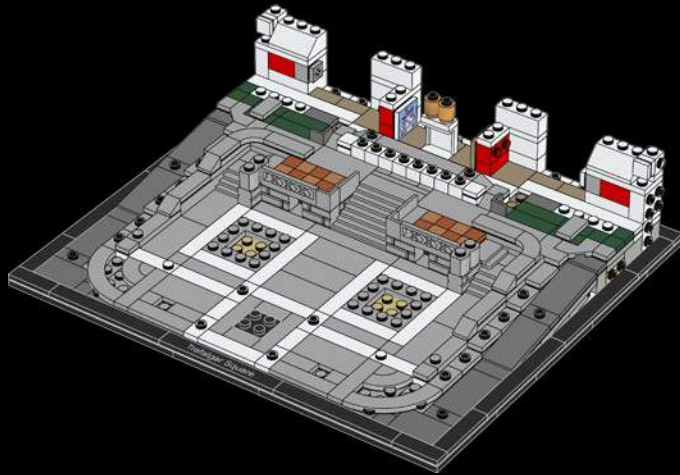



40

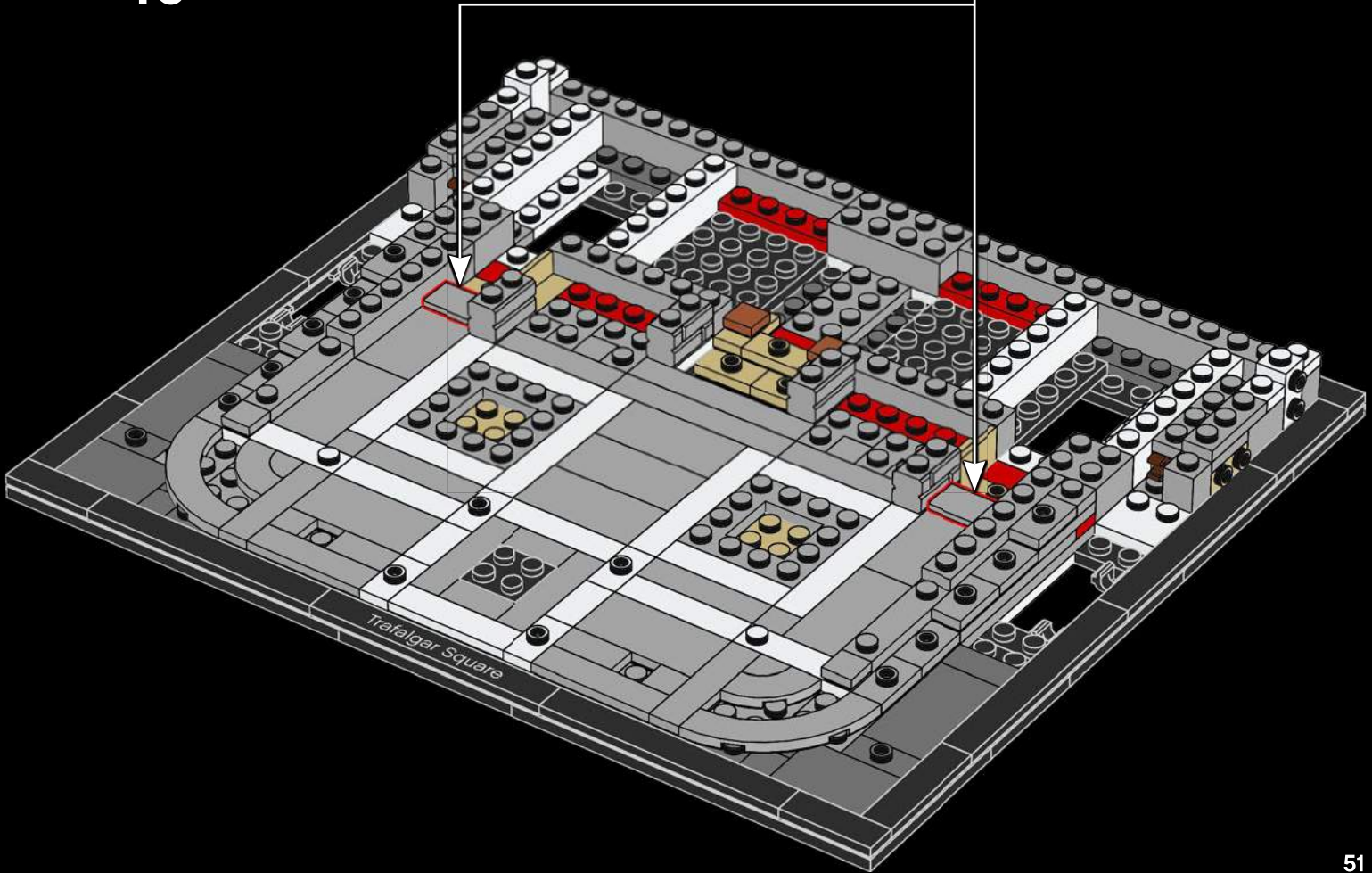



41

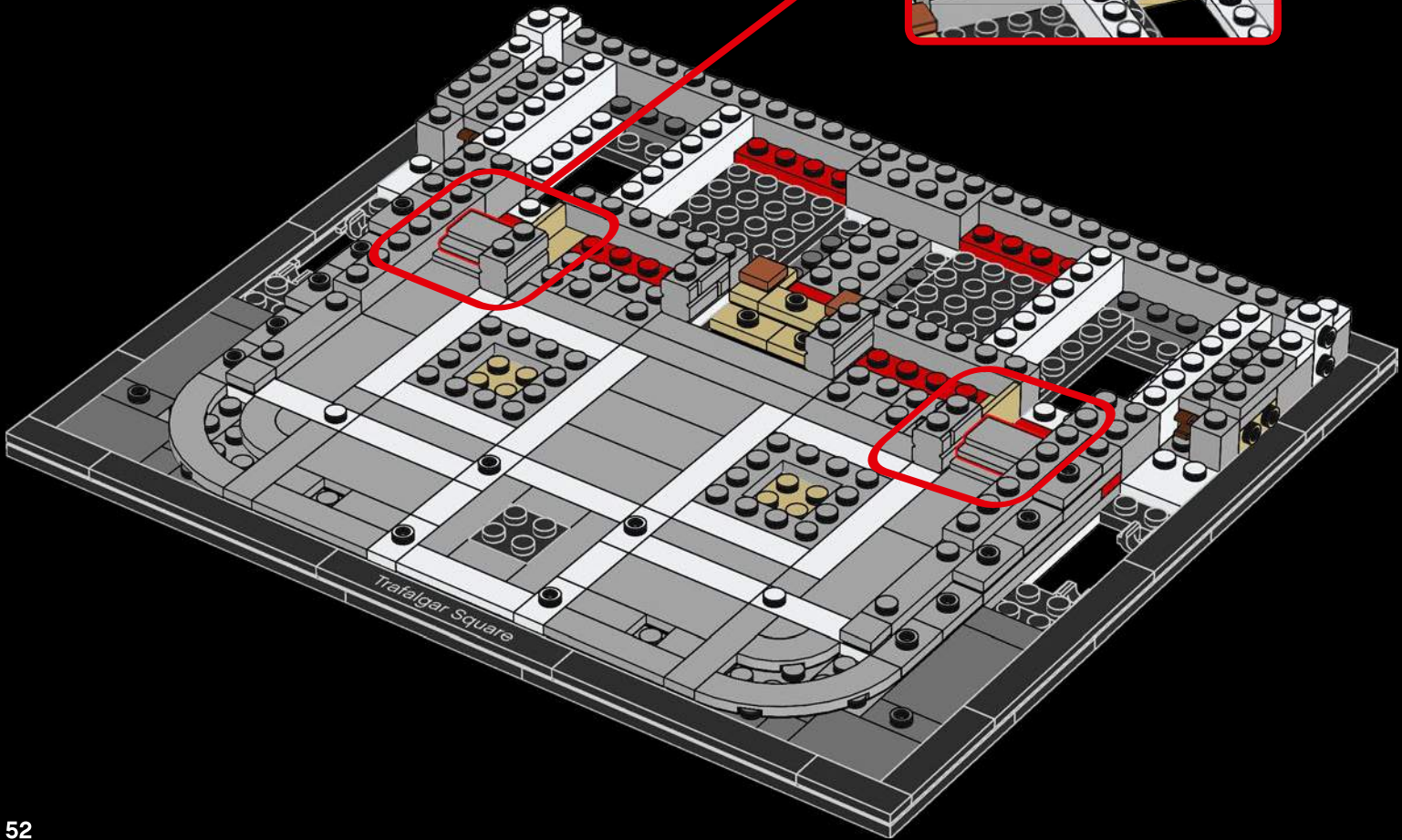
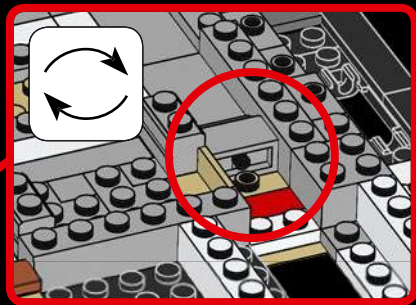
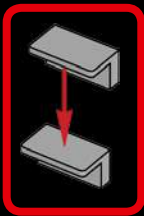

52

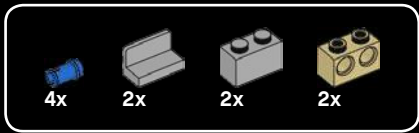

42

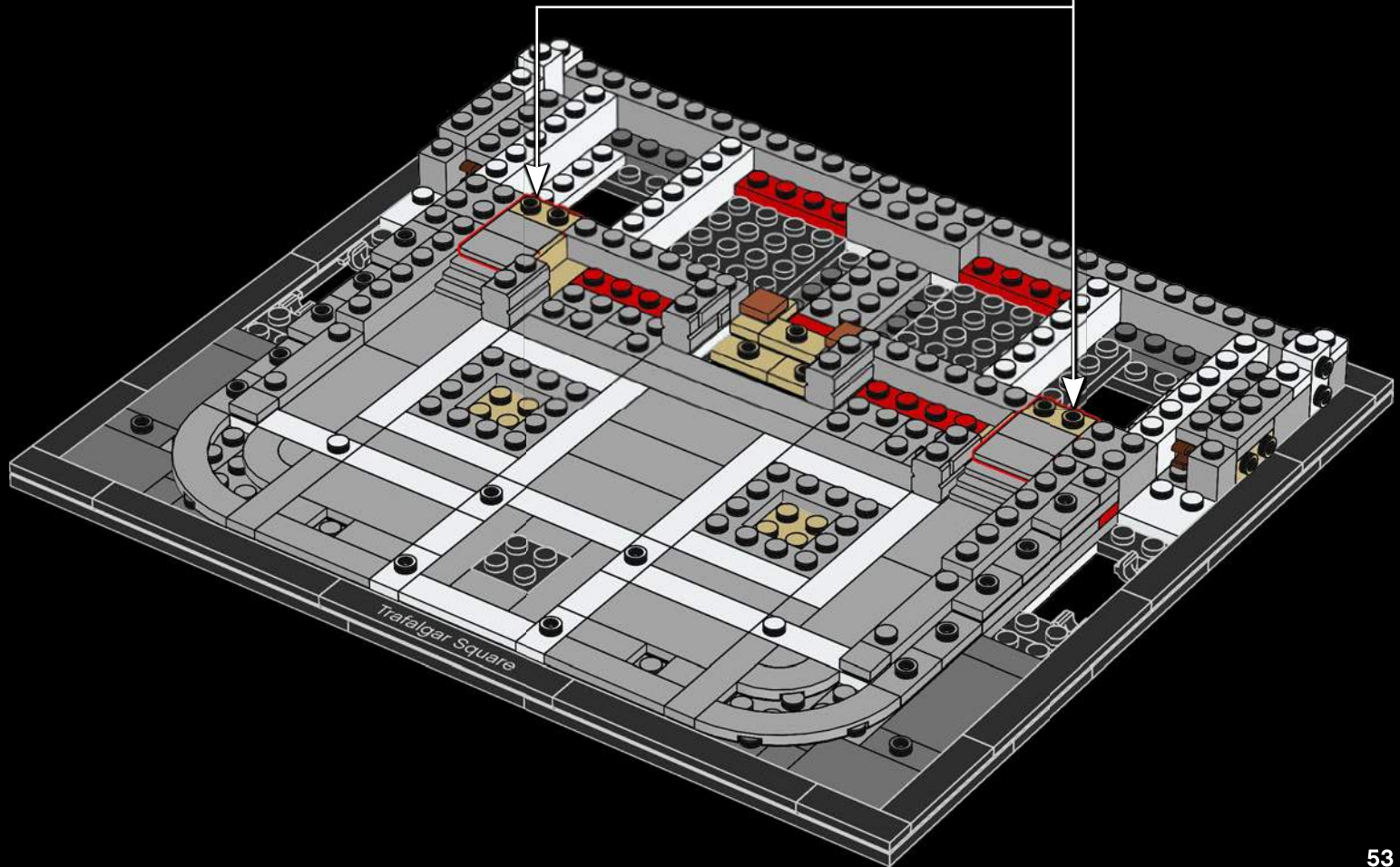
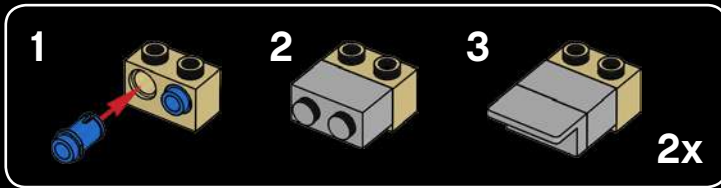



2x



2x

43

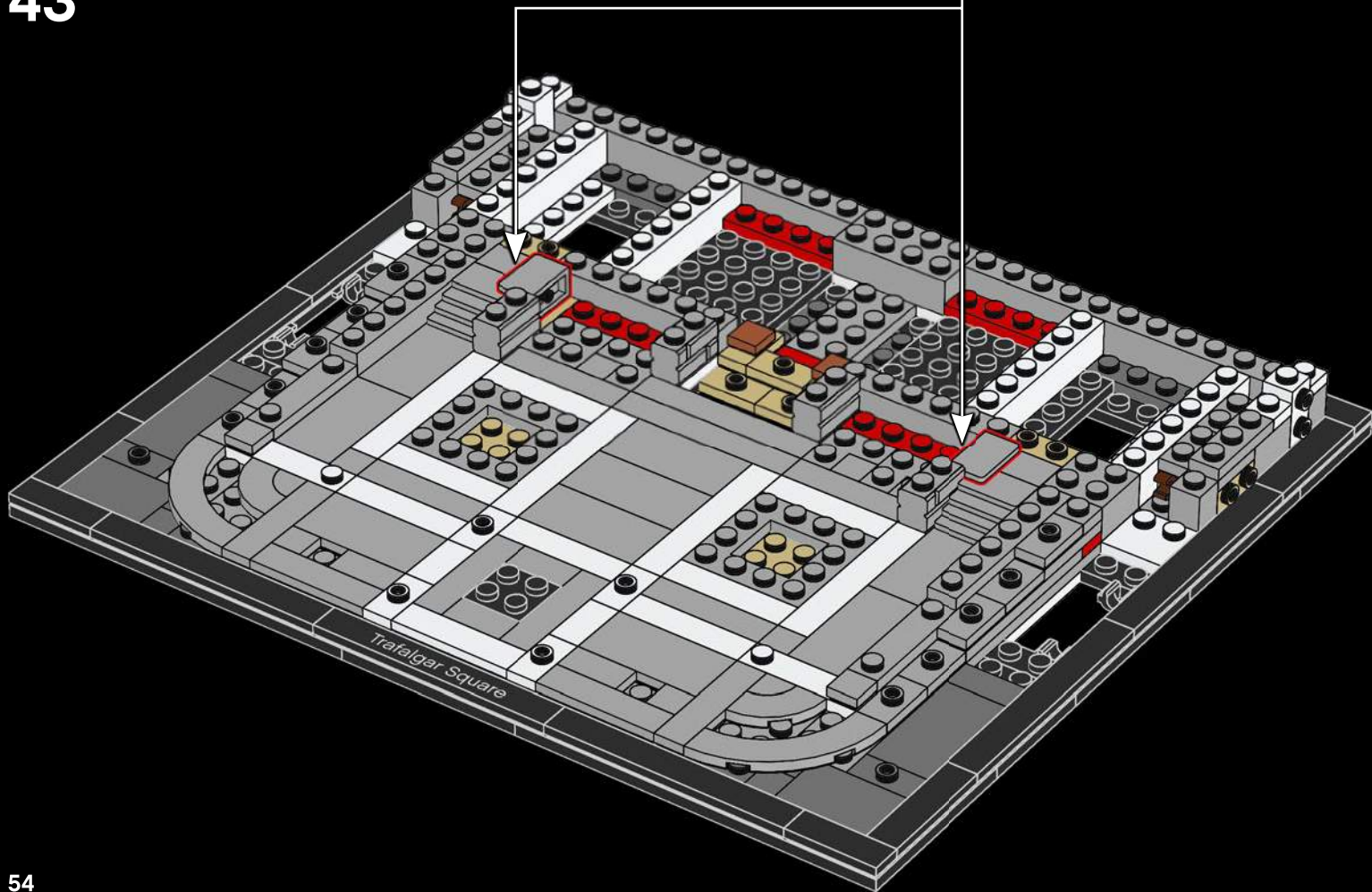

54



44

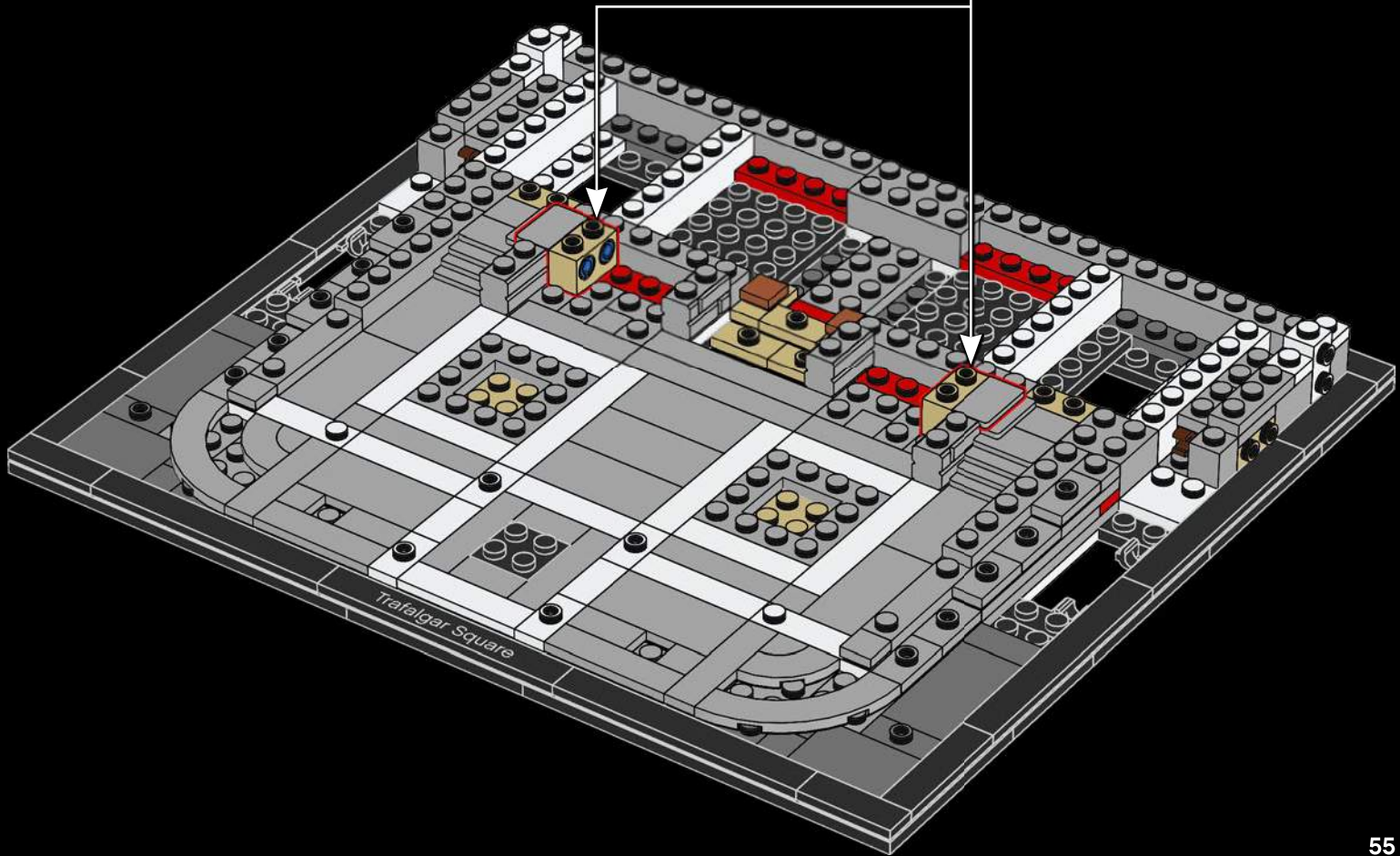
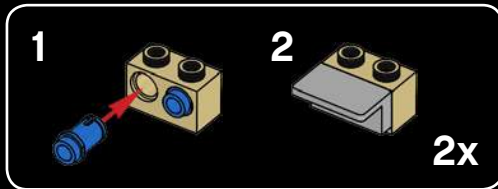

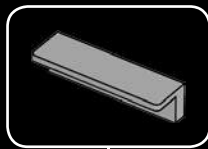
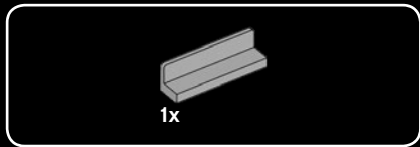

45

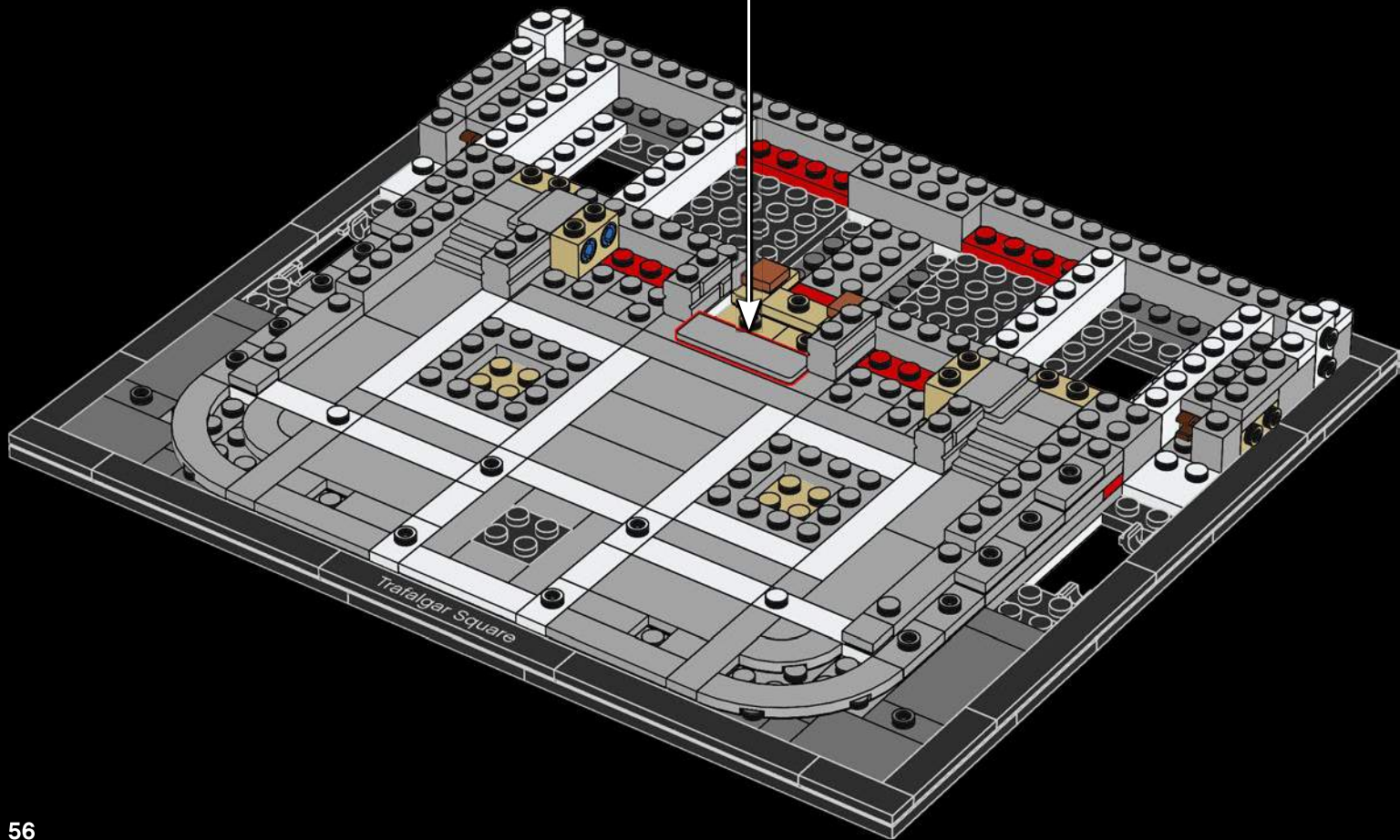



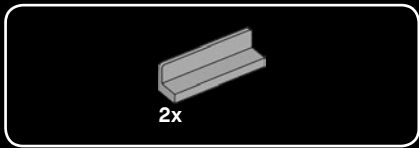

46

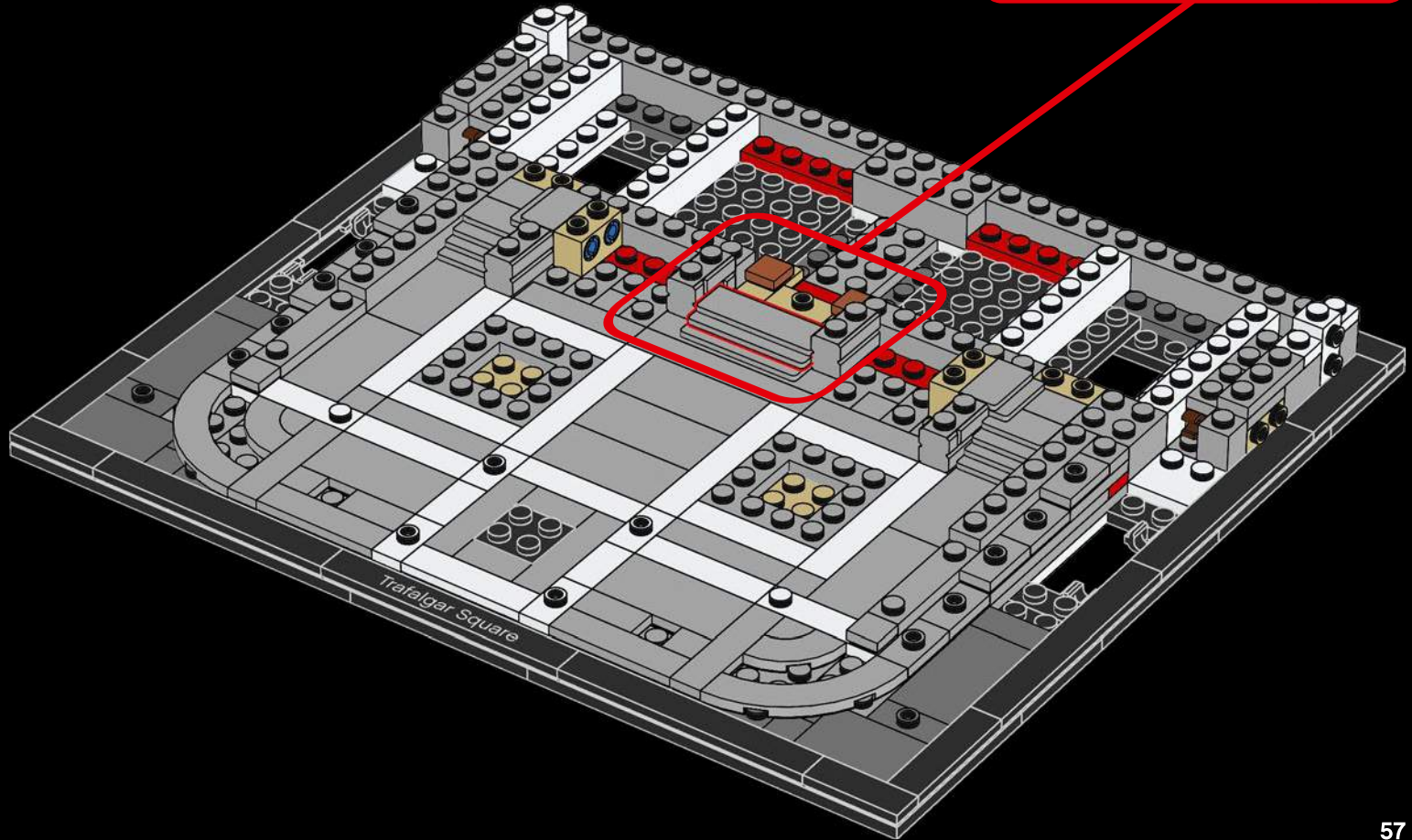
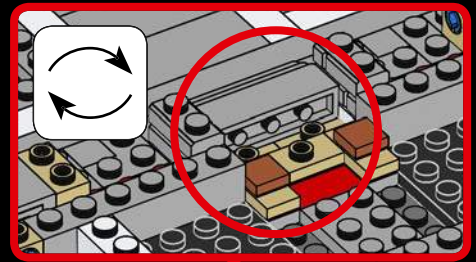
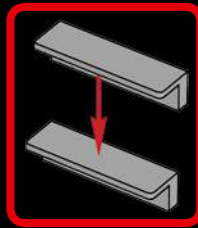

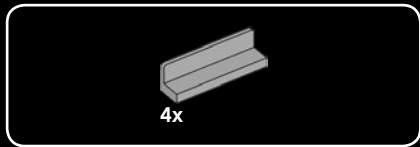

47

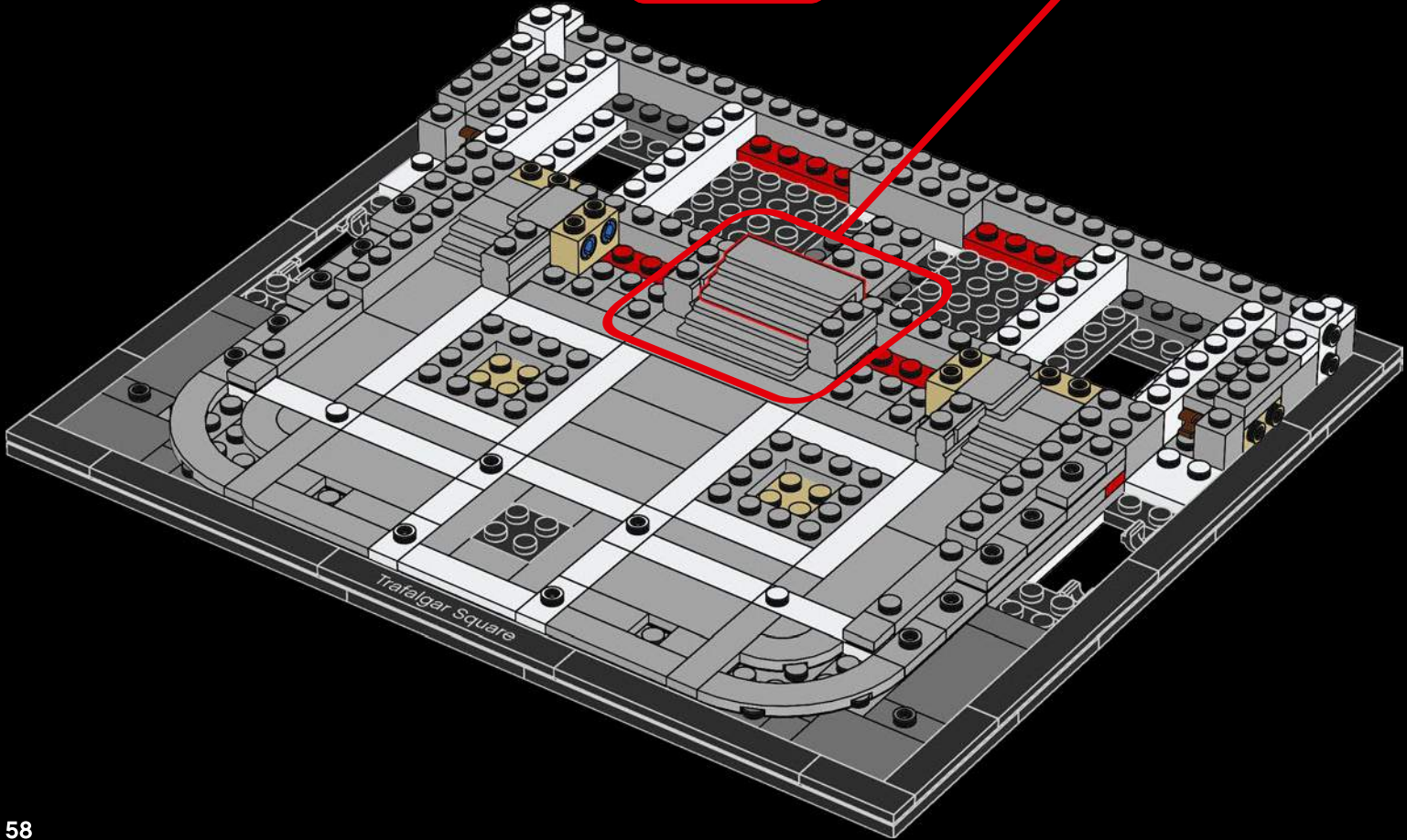
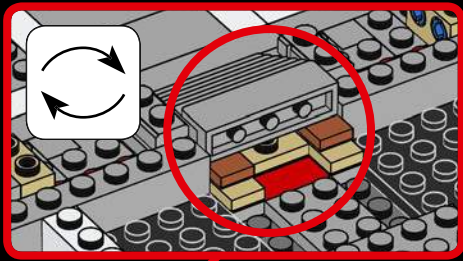
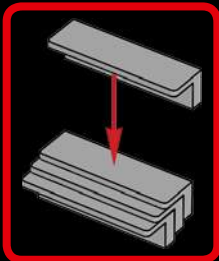

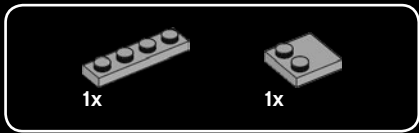

48

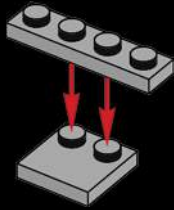

49

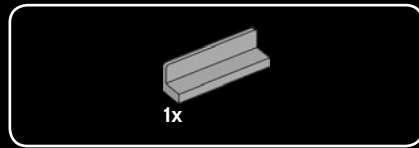
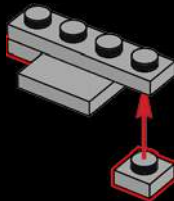

50

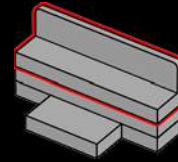

51

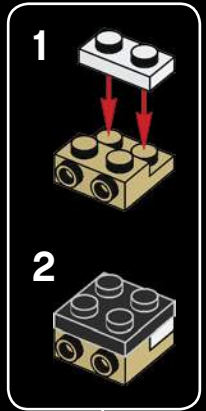
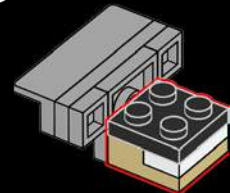
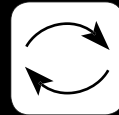

52

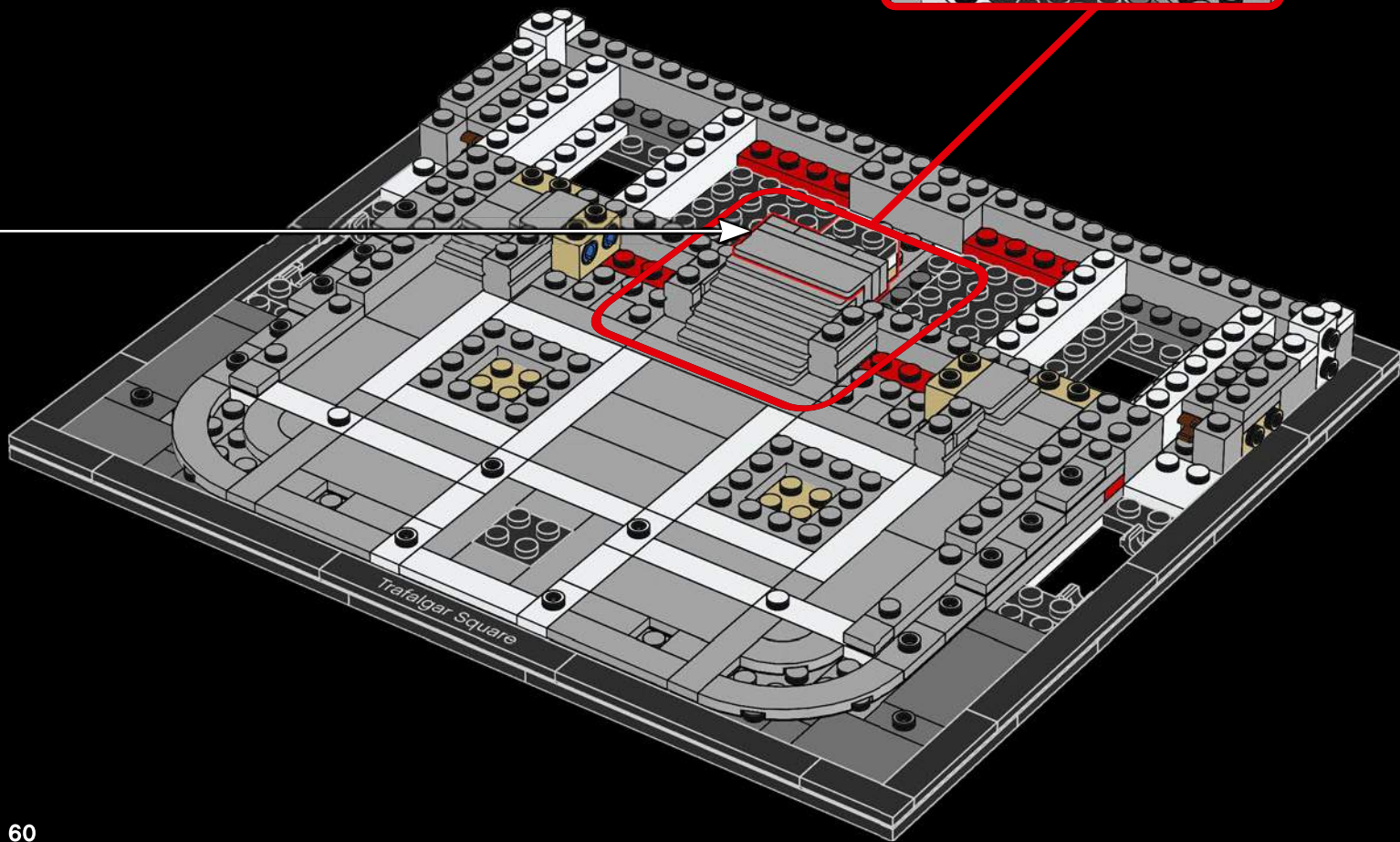
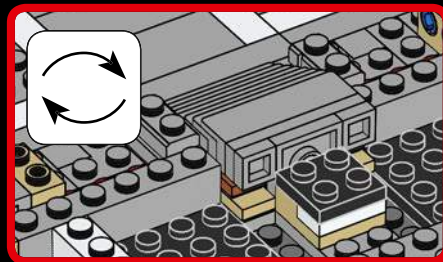

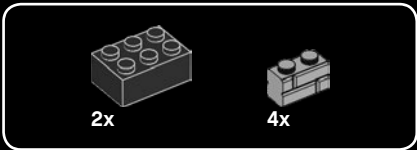

53

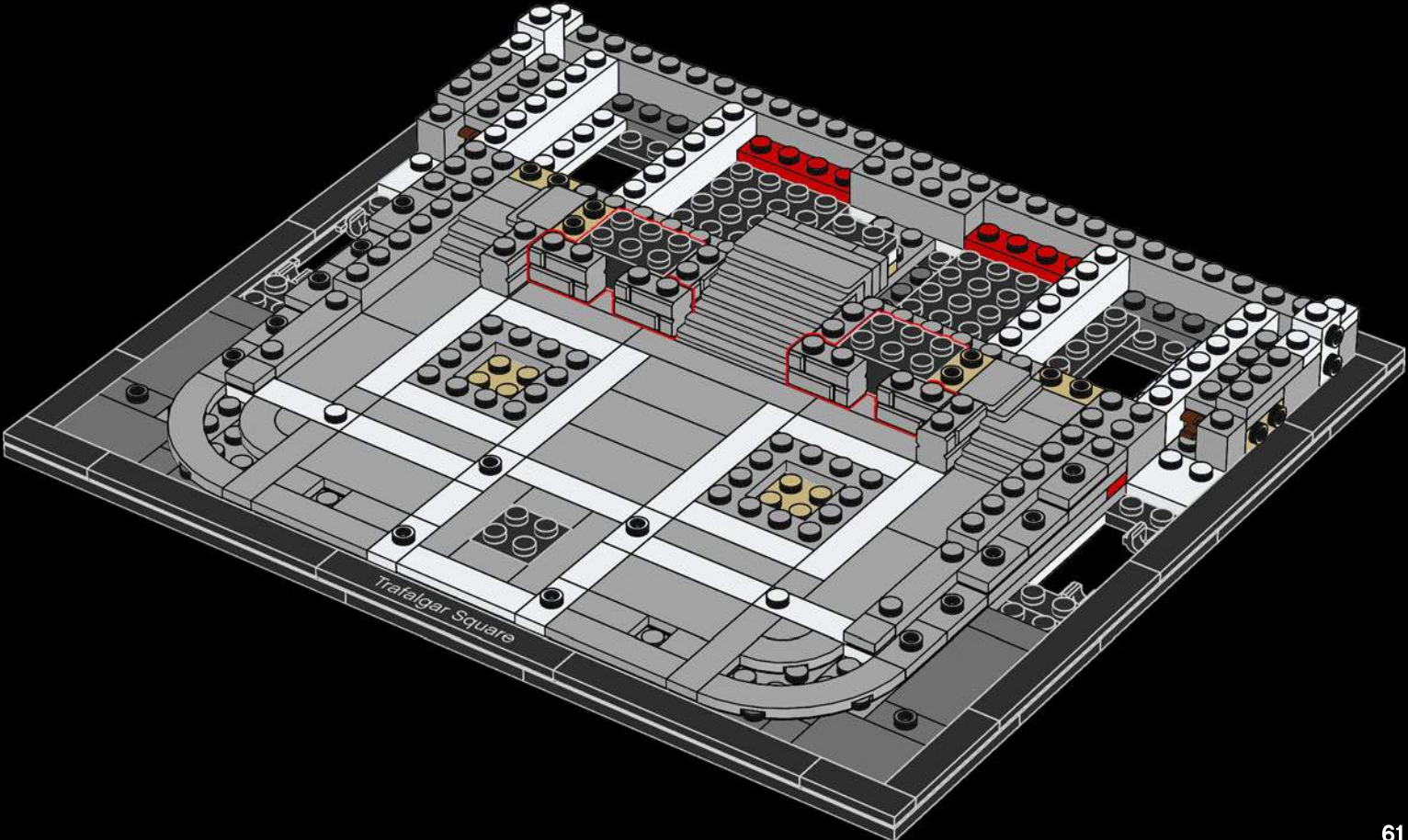

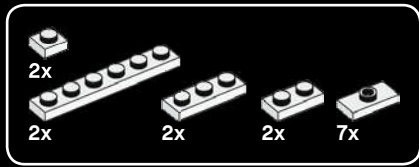

54

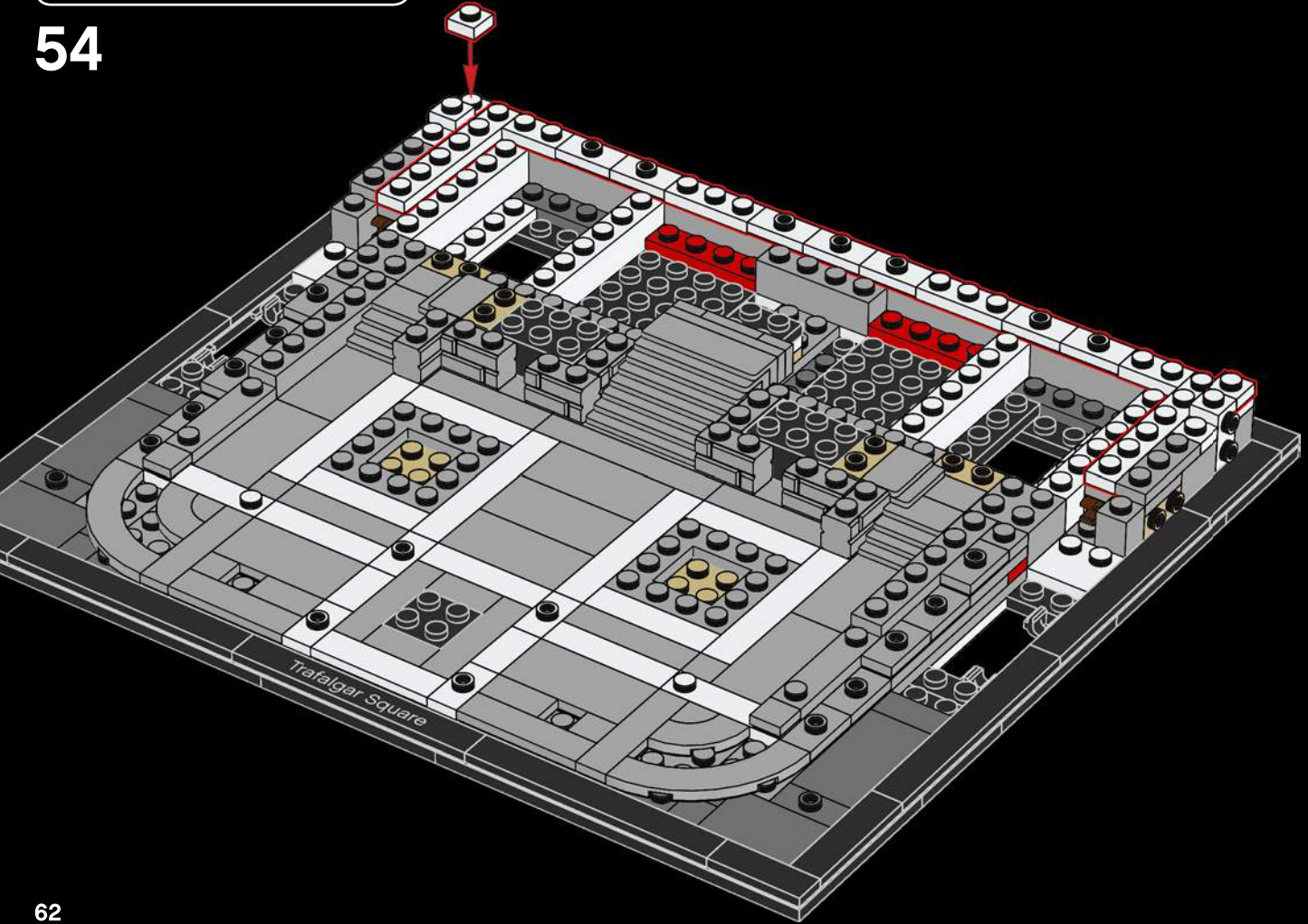

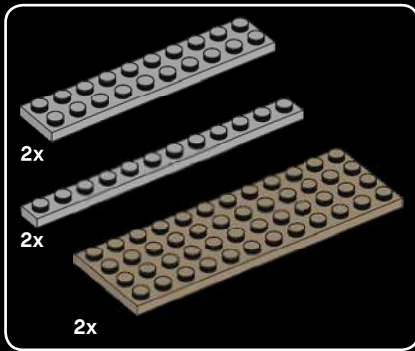

55

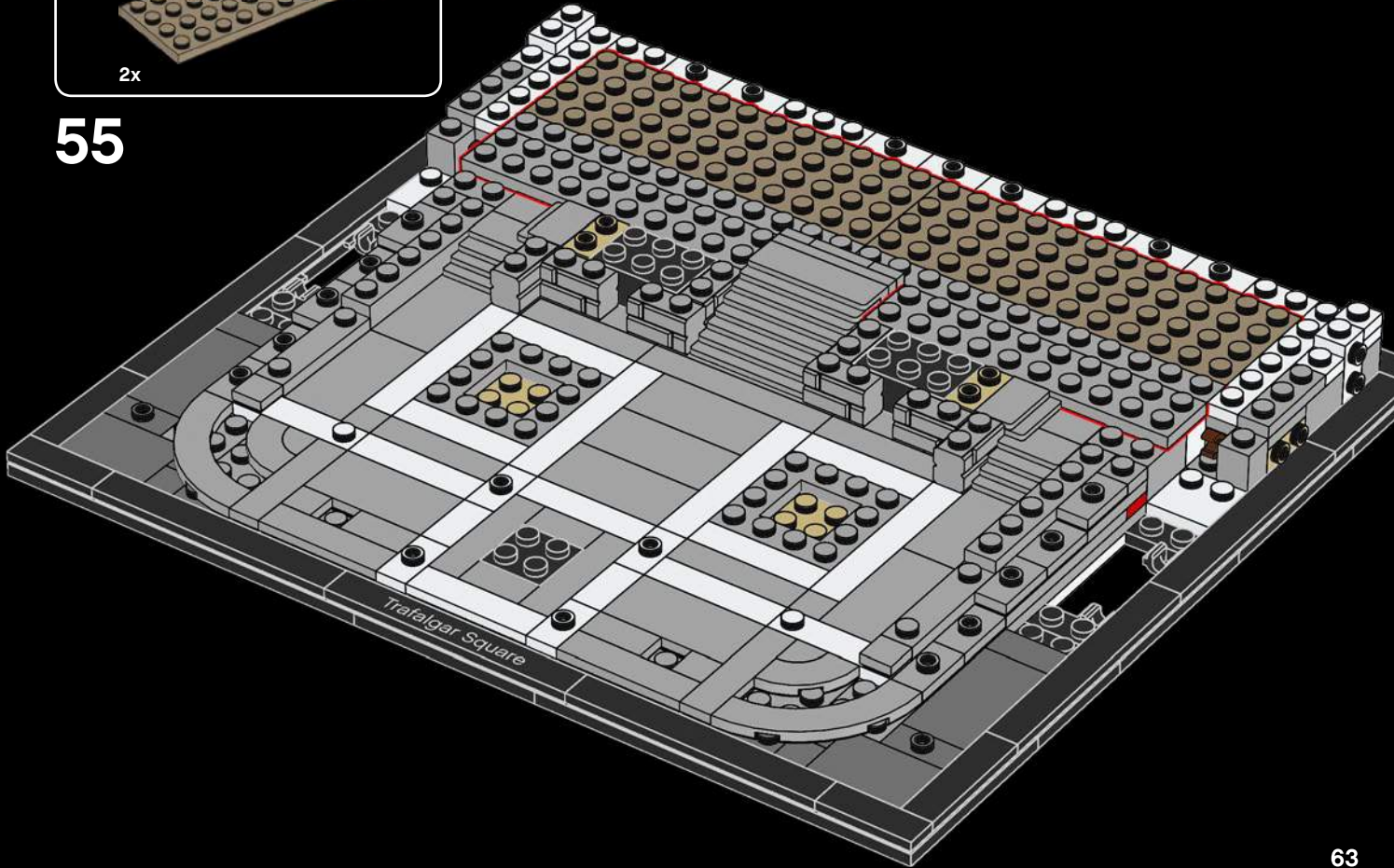

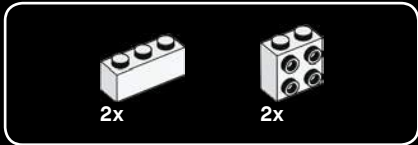

# 56

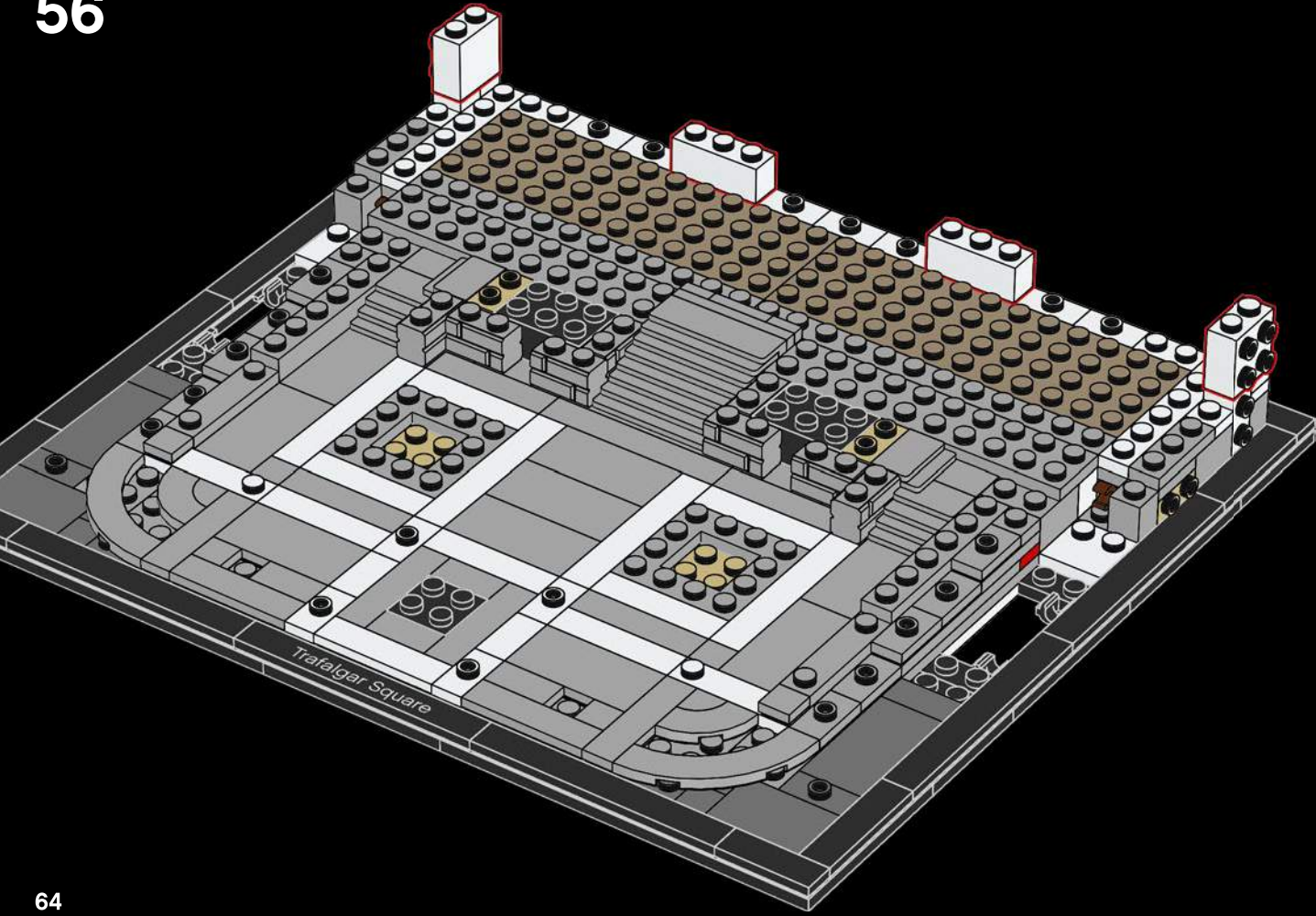



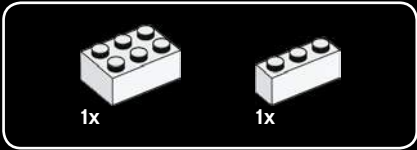

57

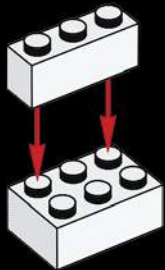

58

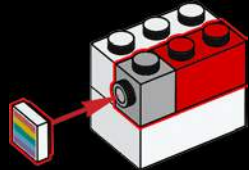

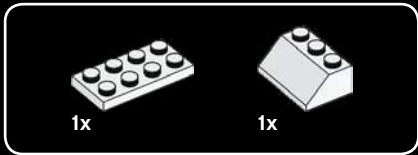

59



60

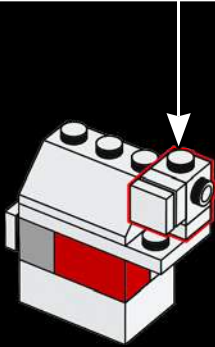
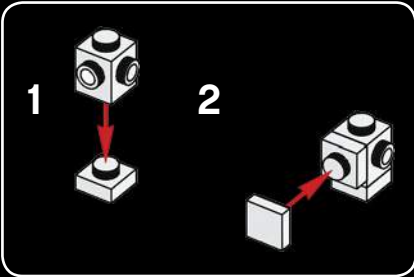

61

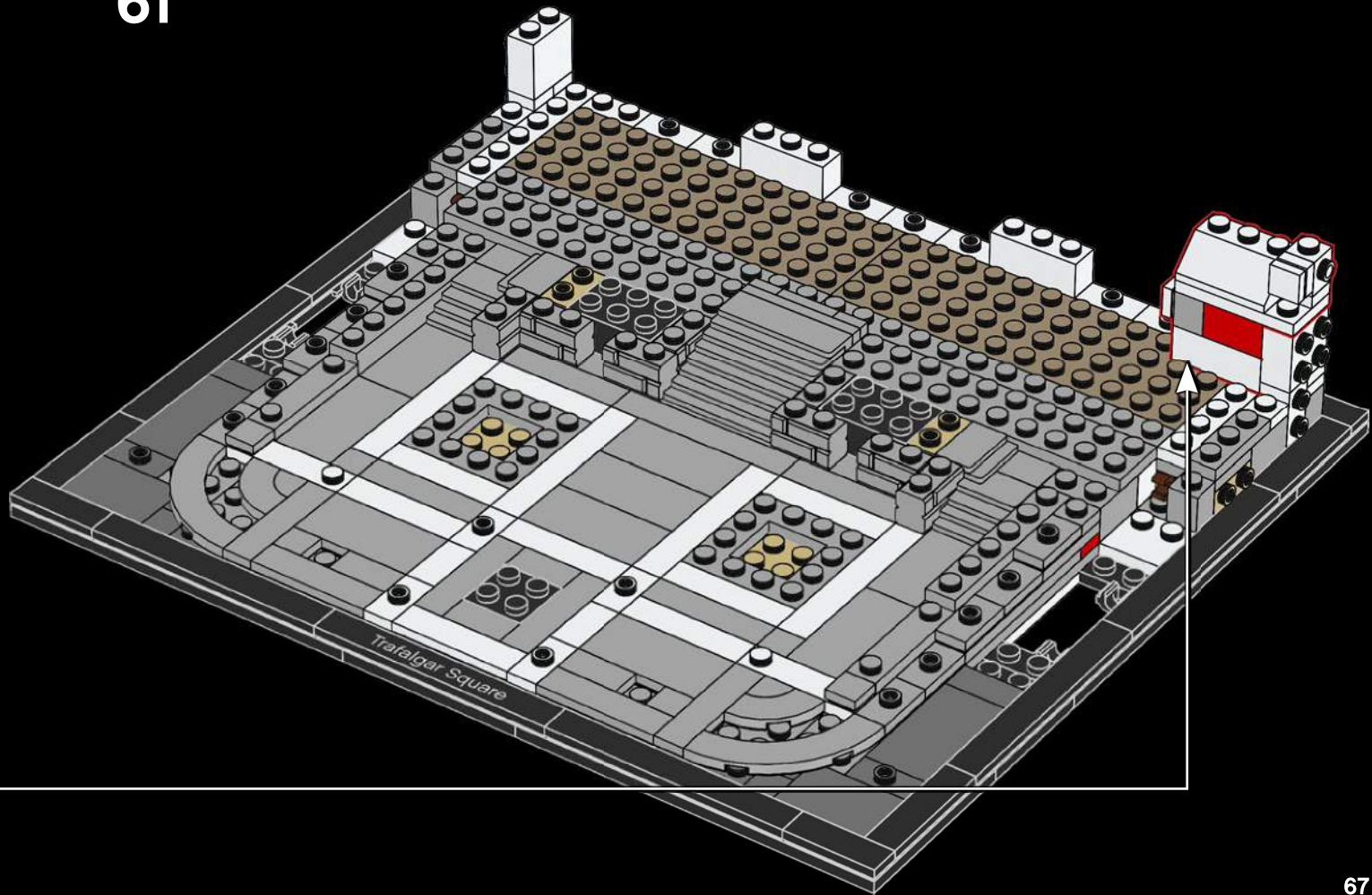

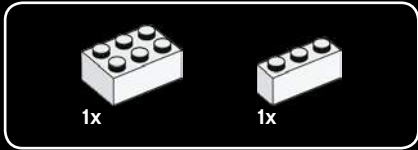

62

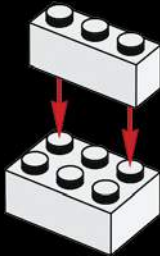

63

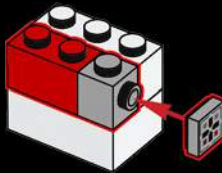

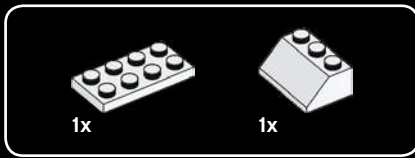

64



65

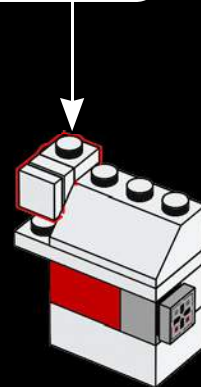
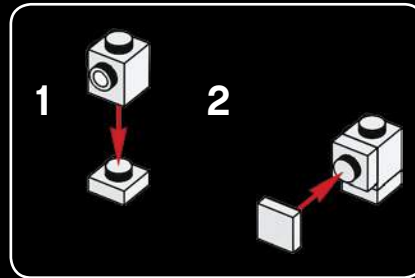

66

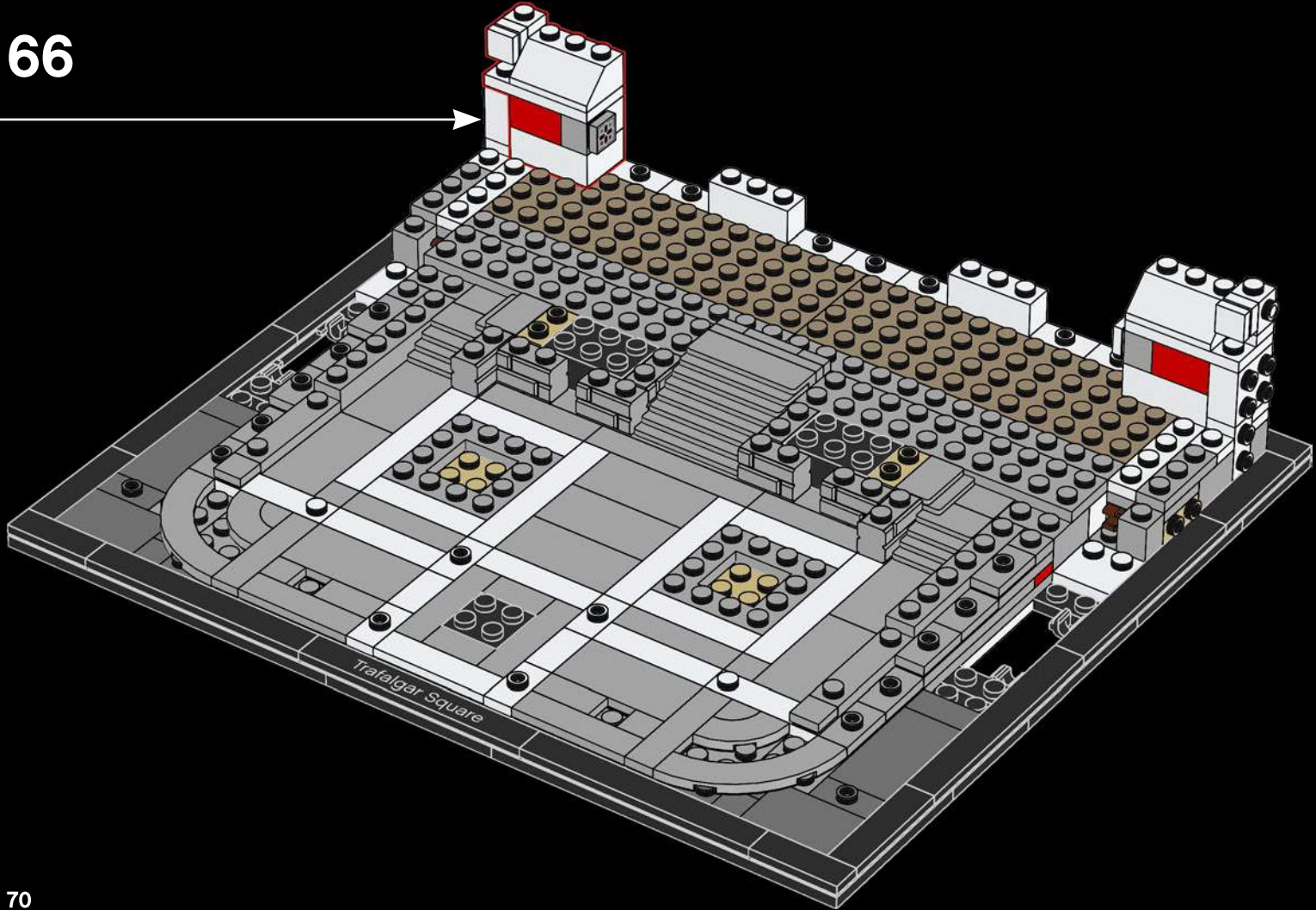

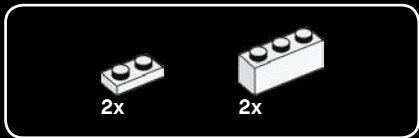

67

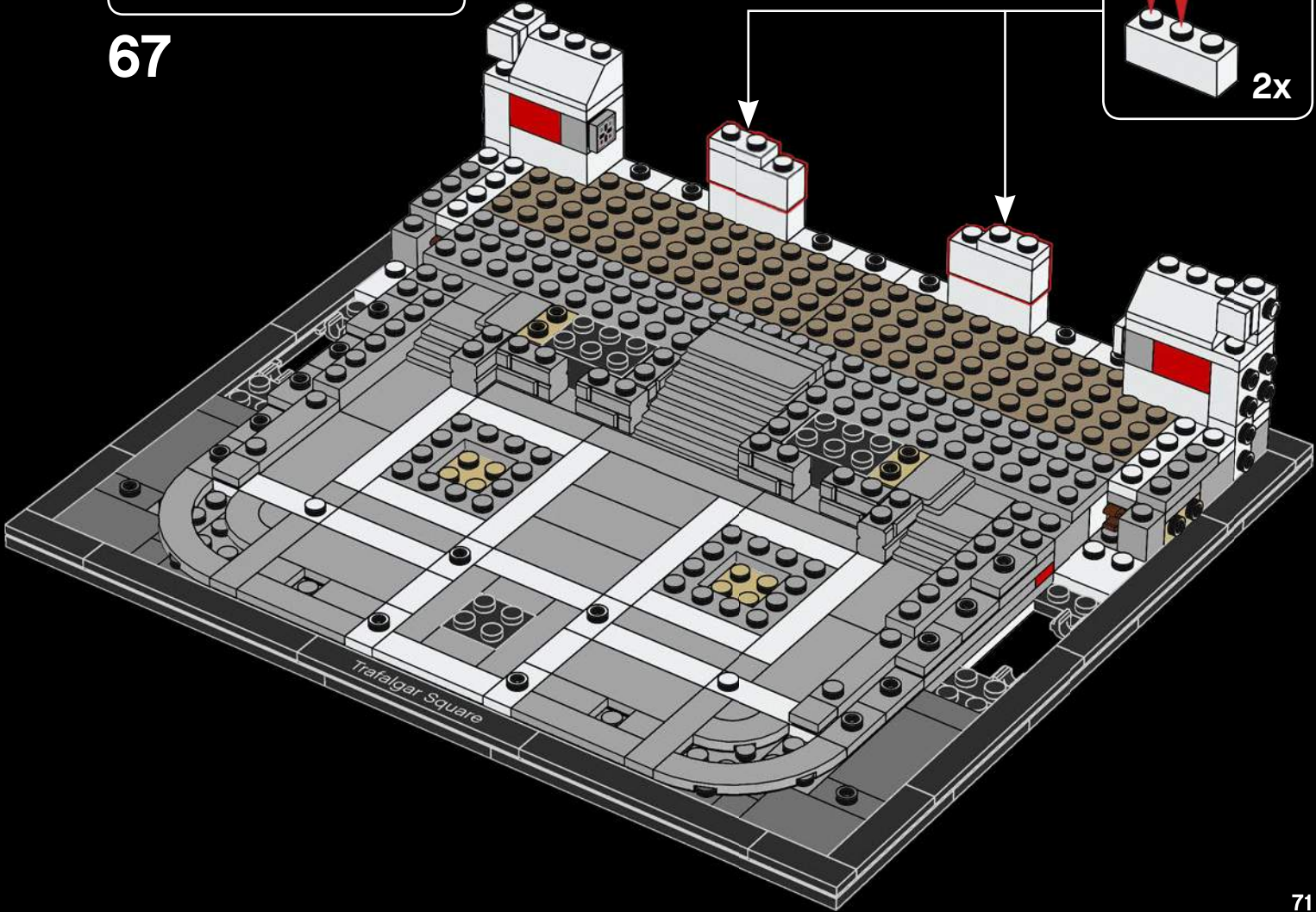
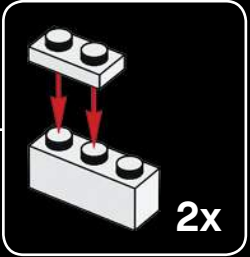

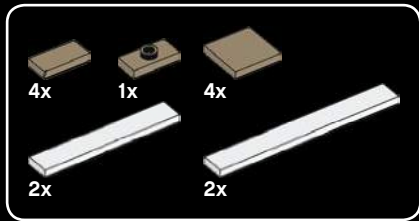

68

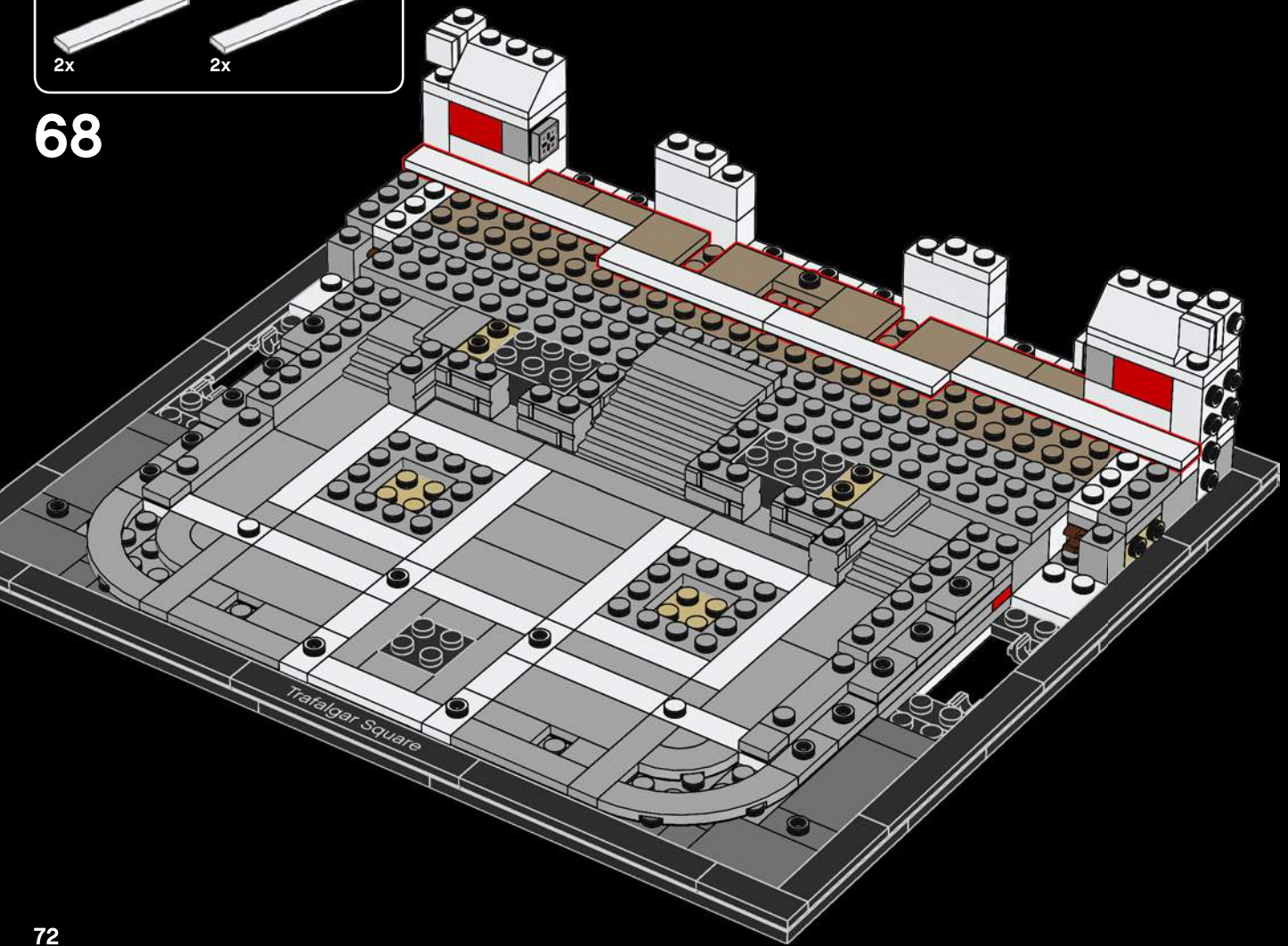



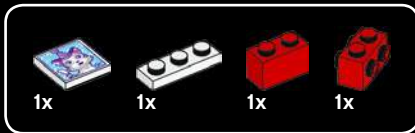

69

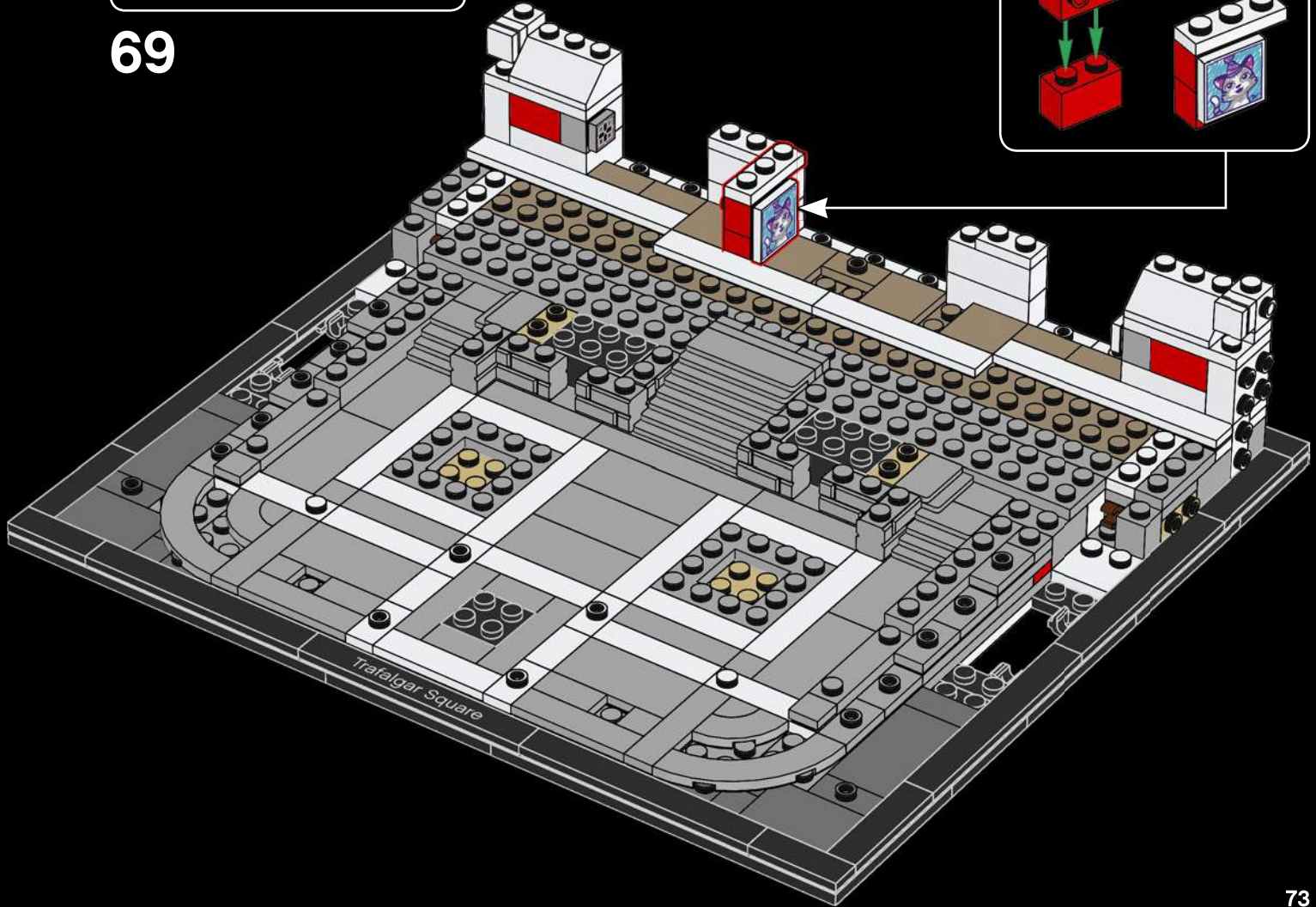
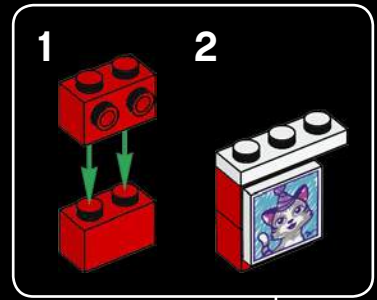

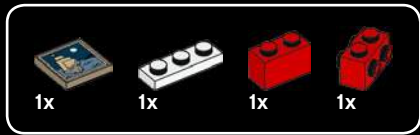

70

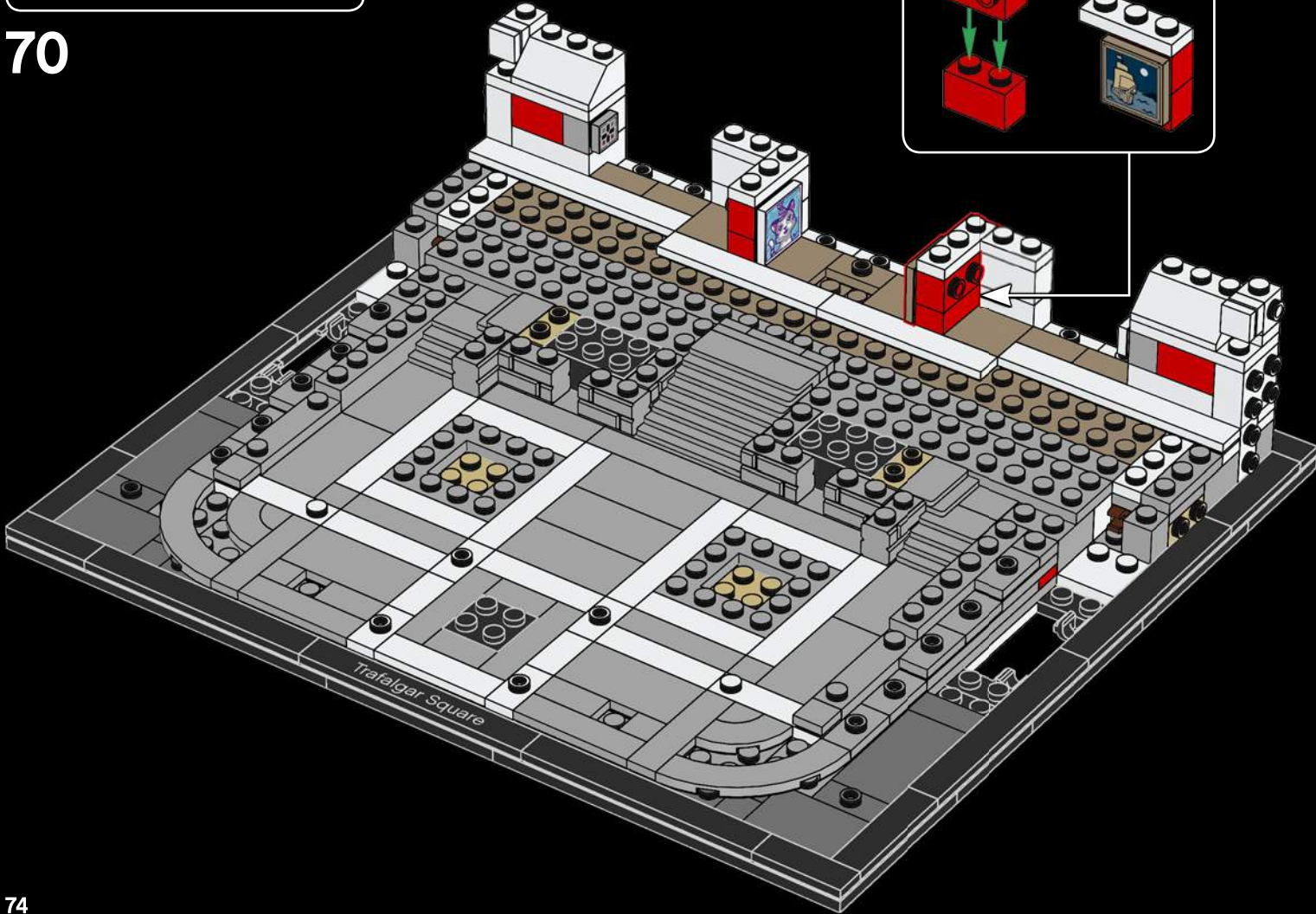
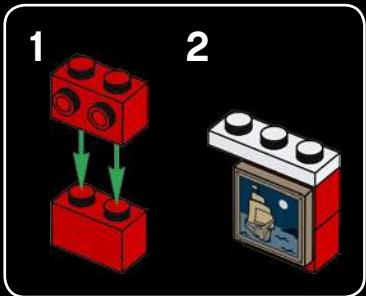



71

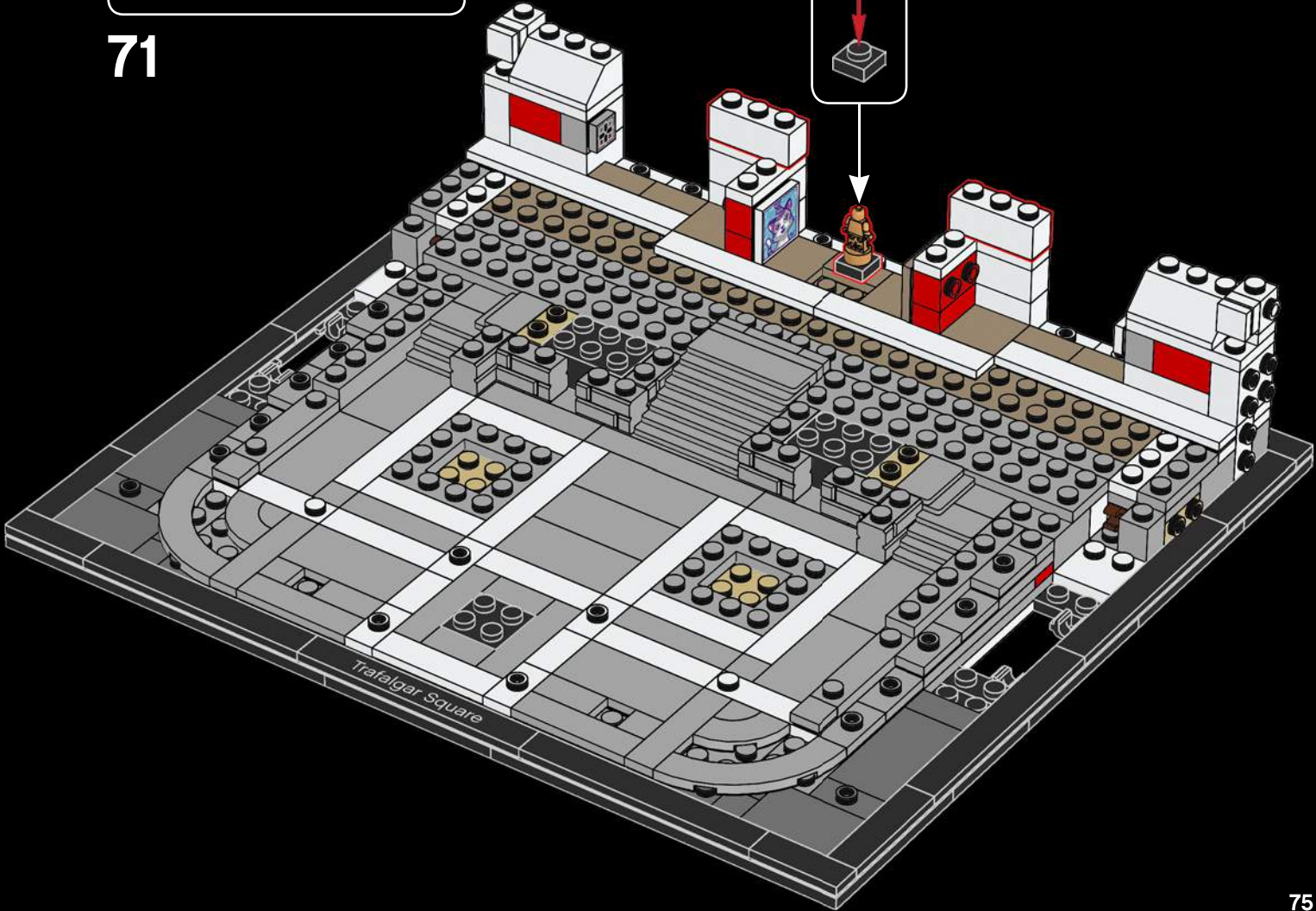
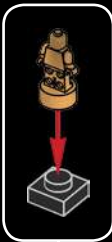



72

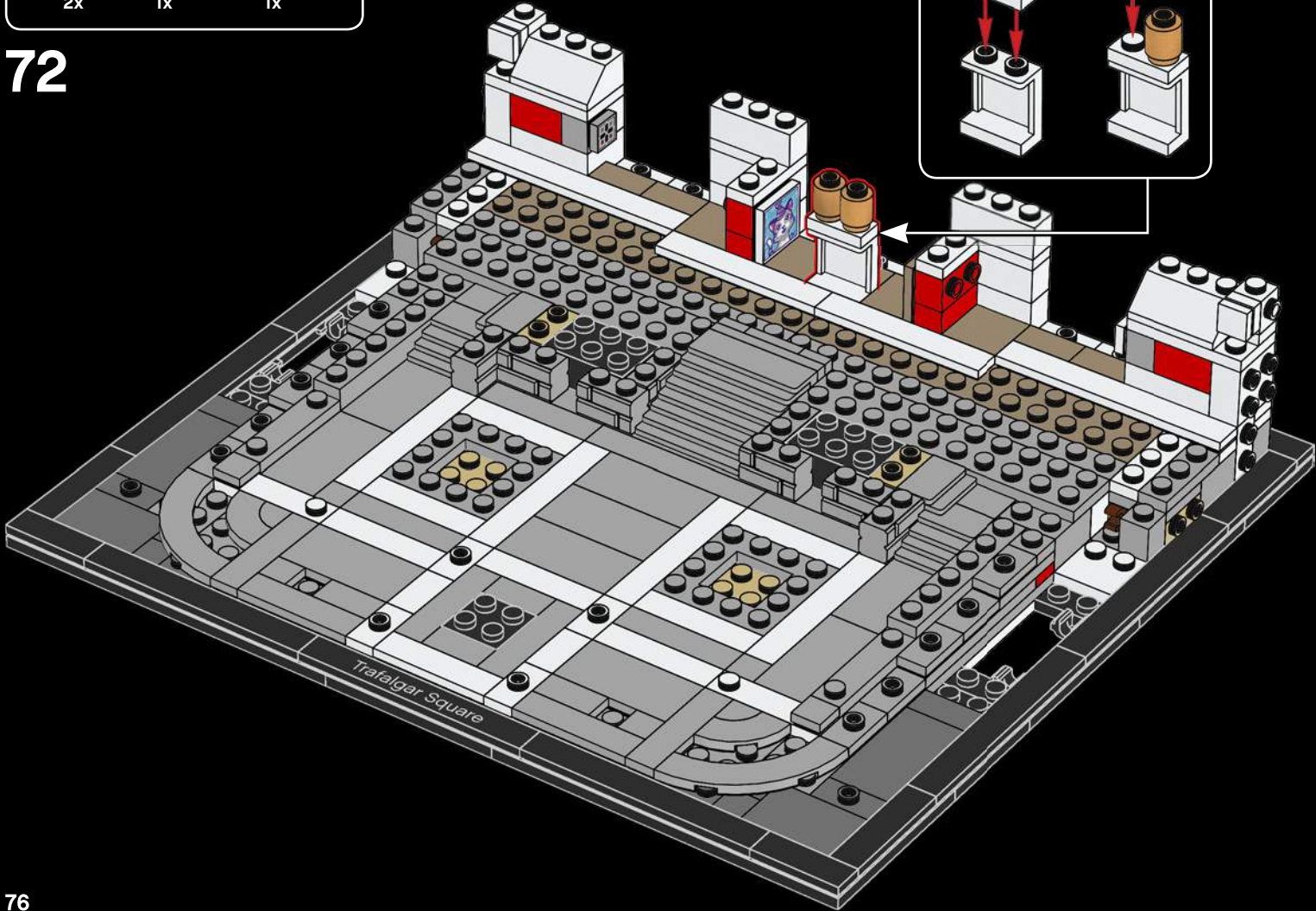
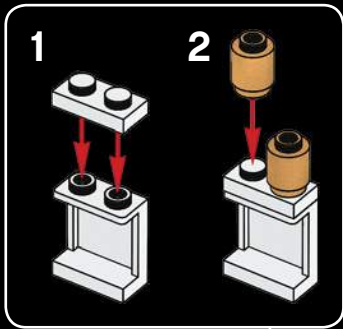

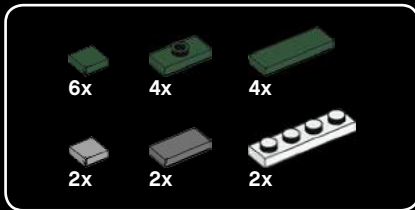

73

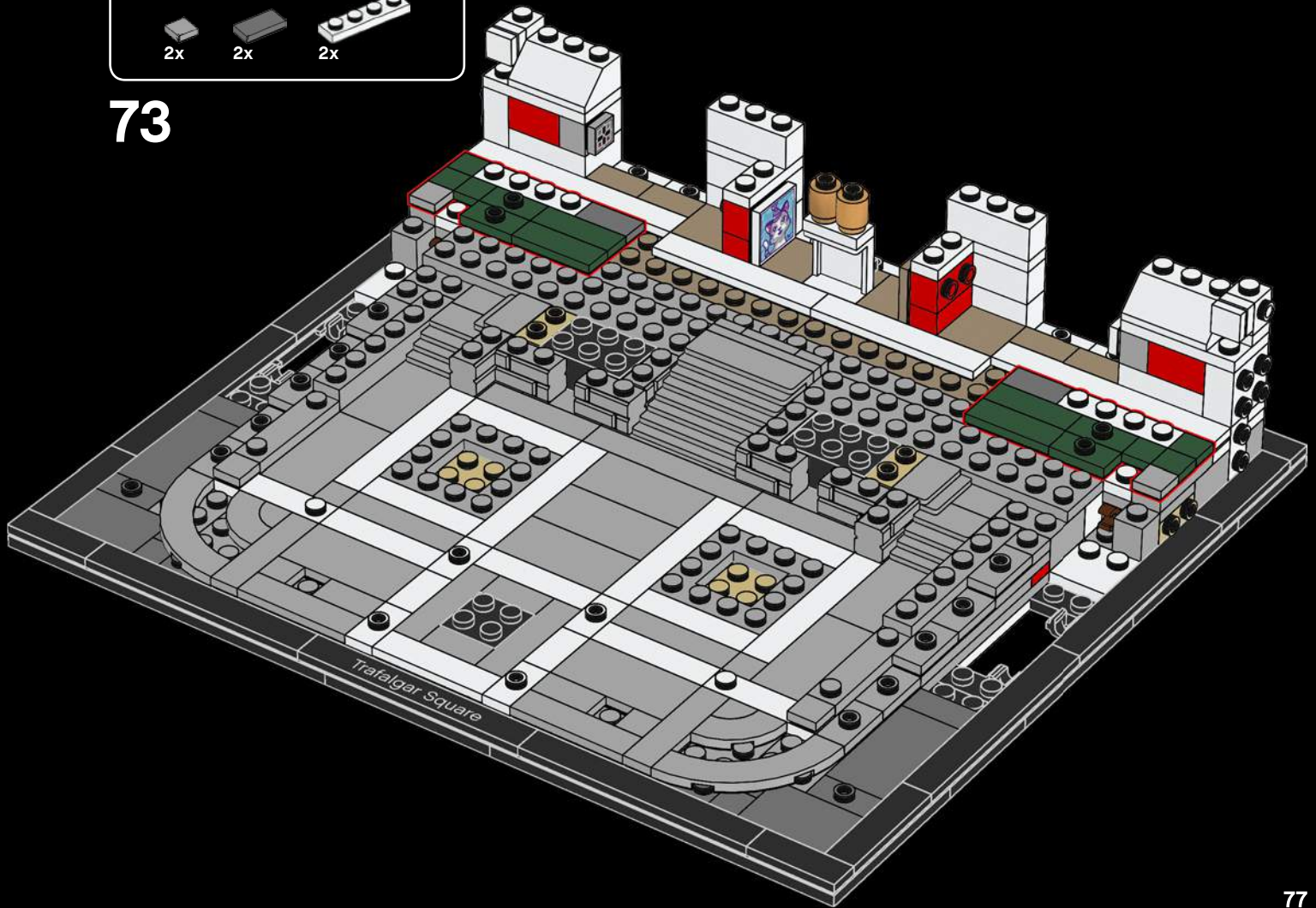

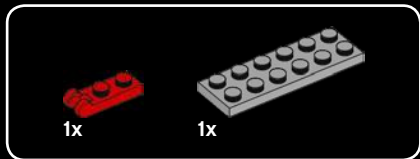
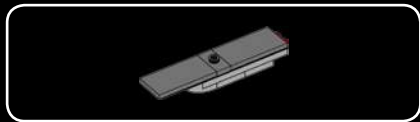

1x

1x

# 74

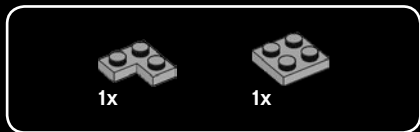
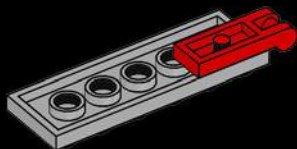

1x

1x

# 75

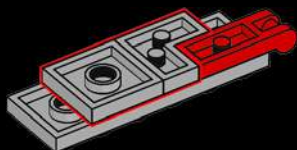

1x

# 76

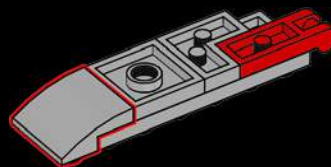

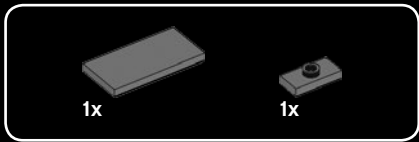

77

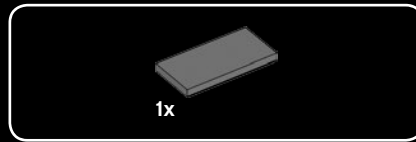
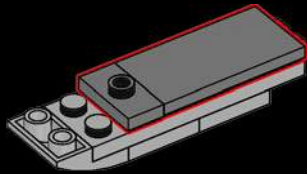

78

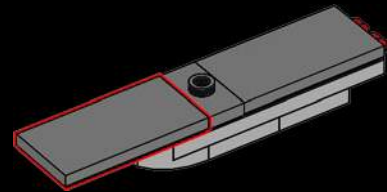

79

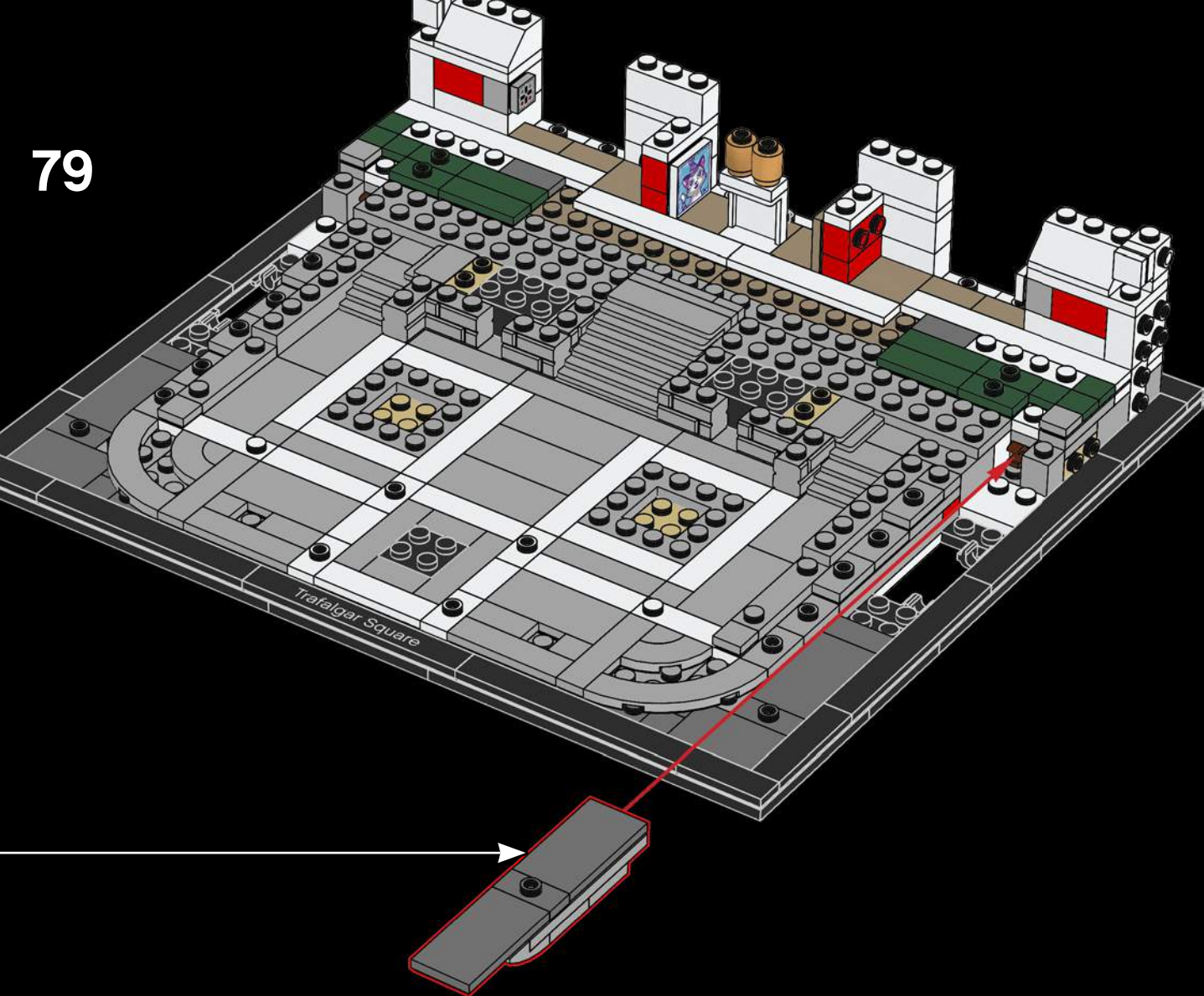

80



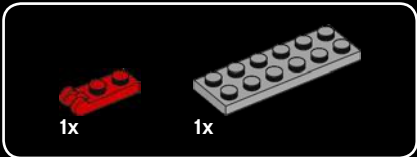

80

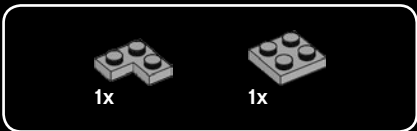
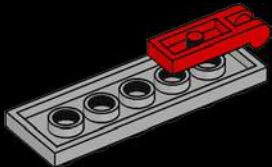

81

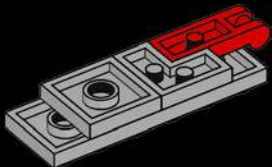

82

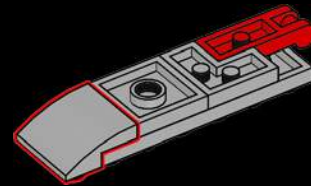

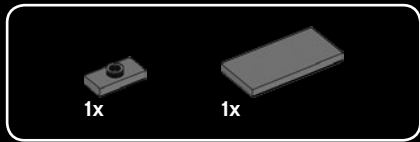

83

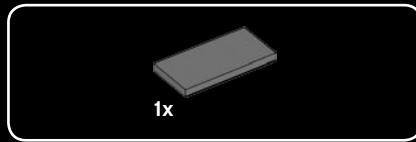
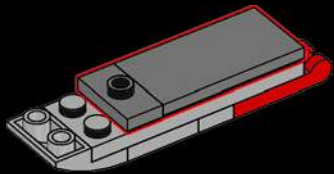

84

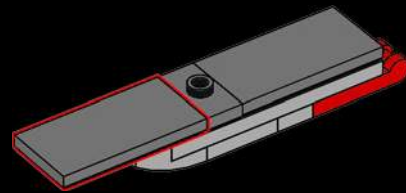

85

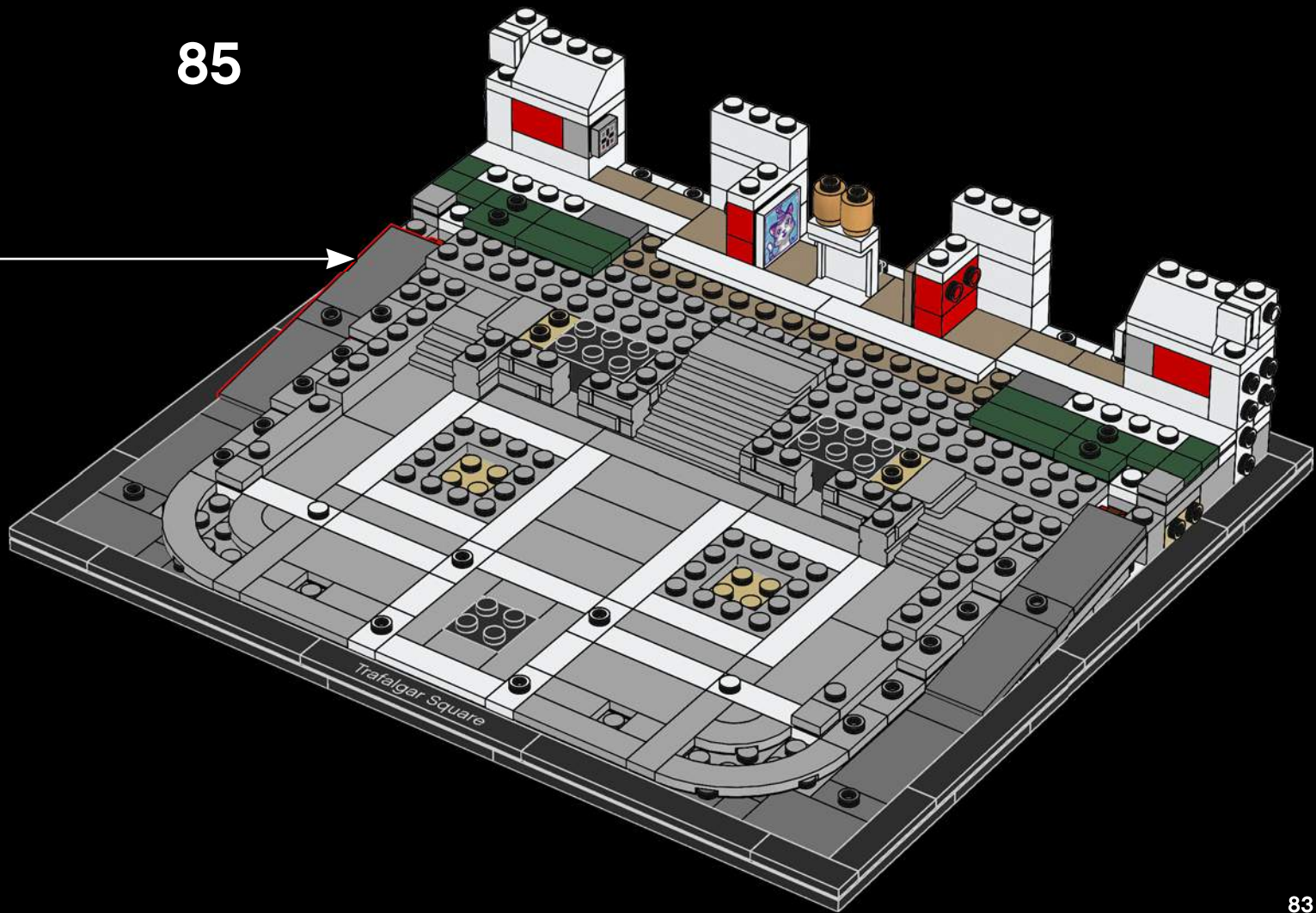

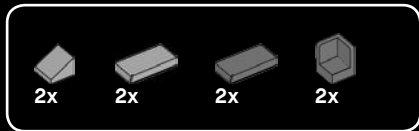

86

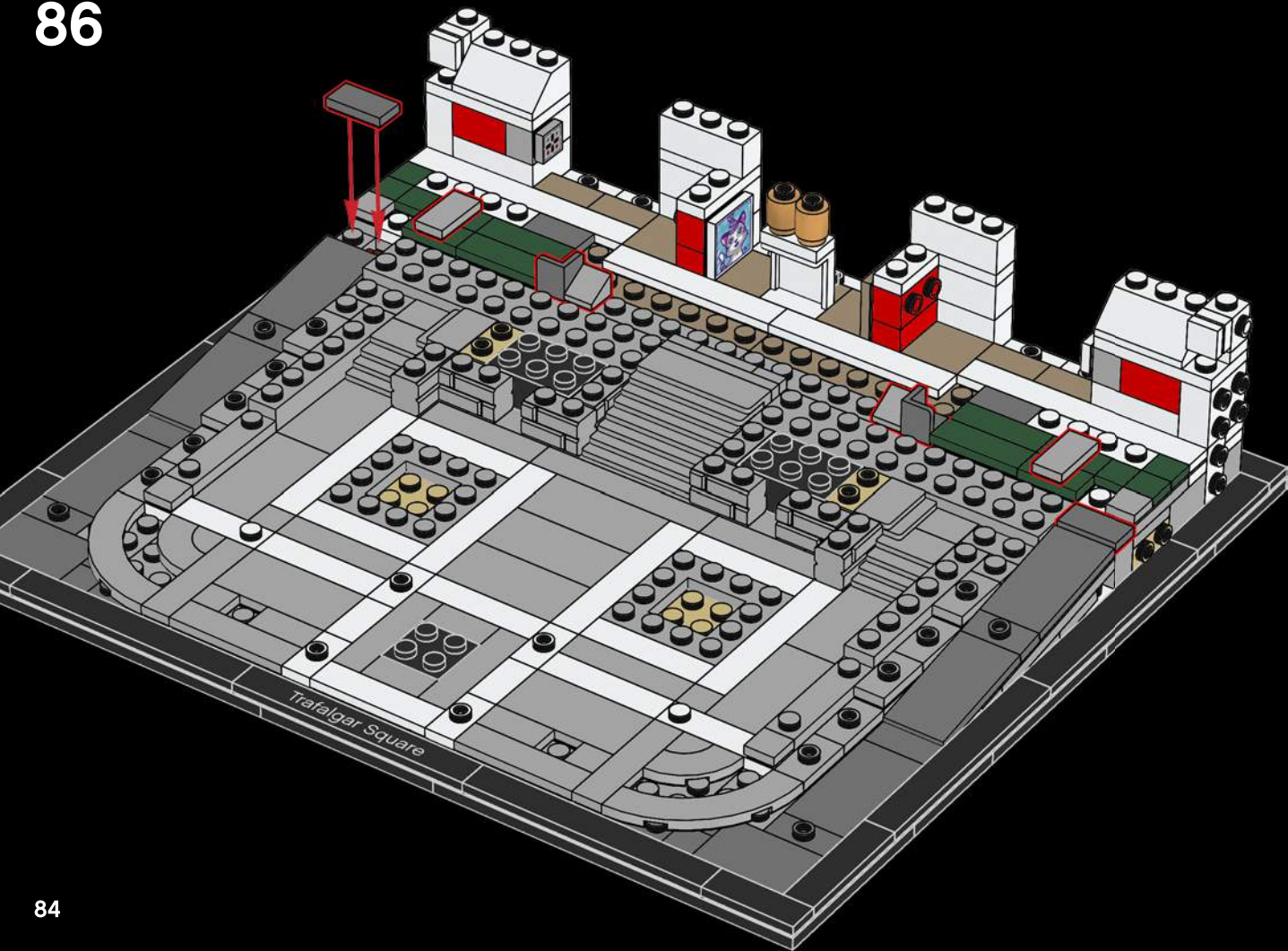



87

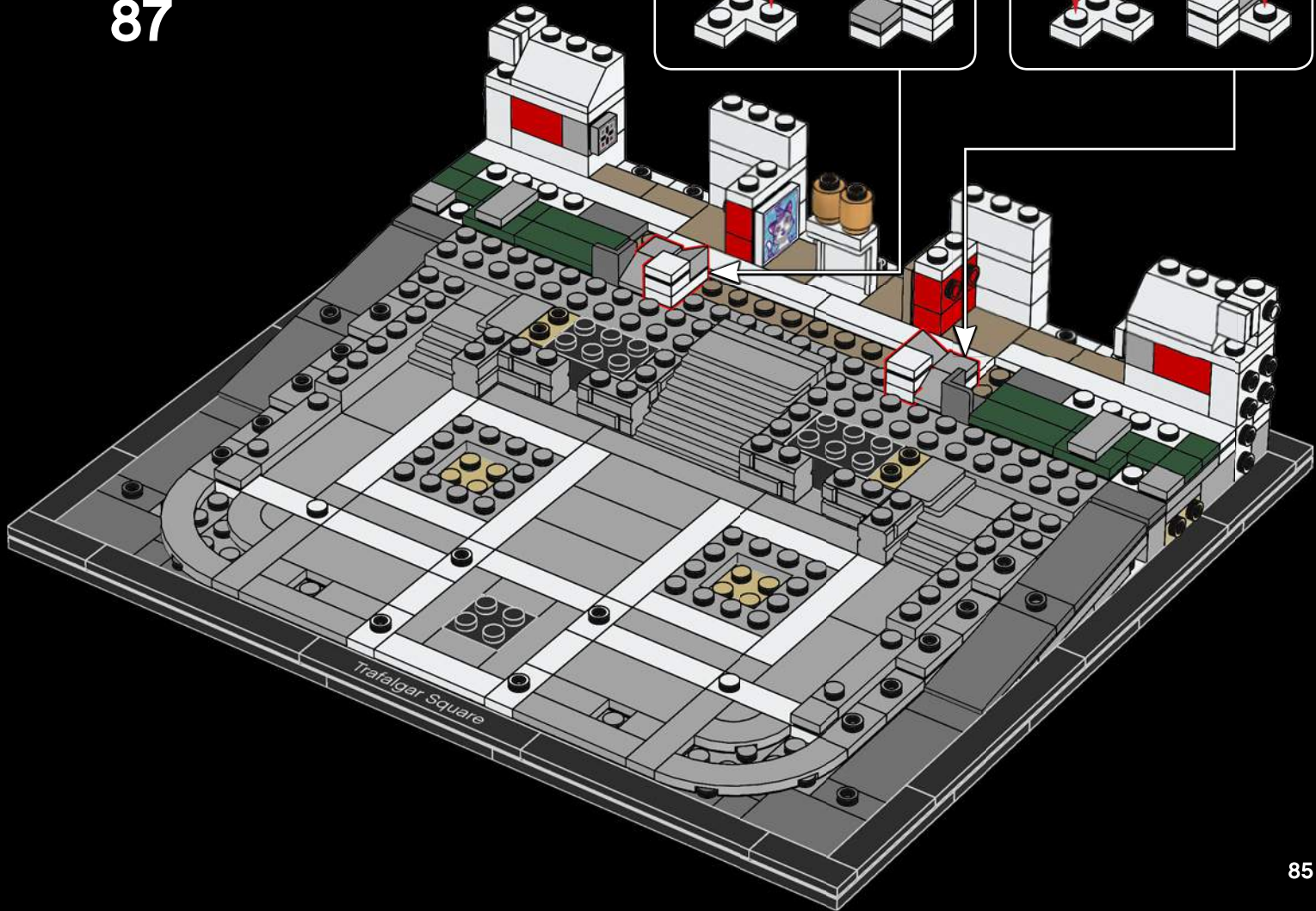
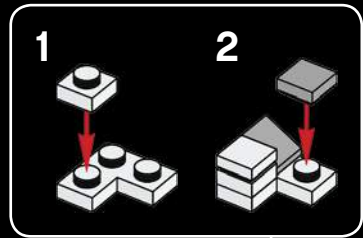
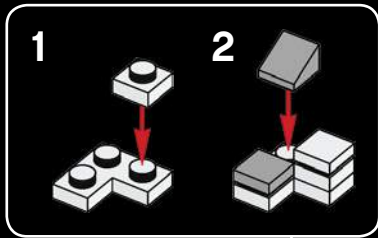

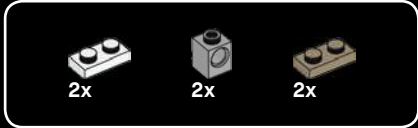

88

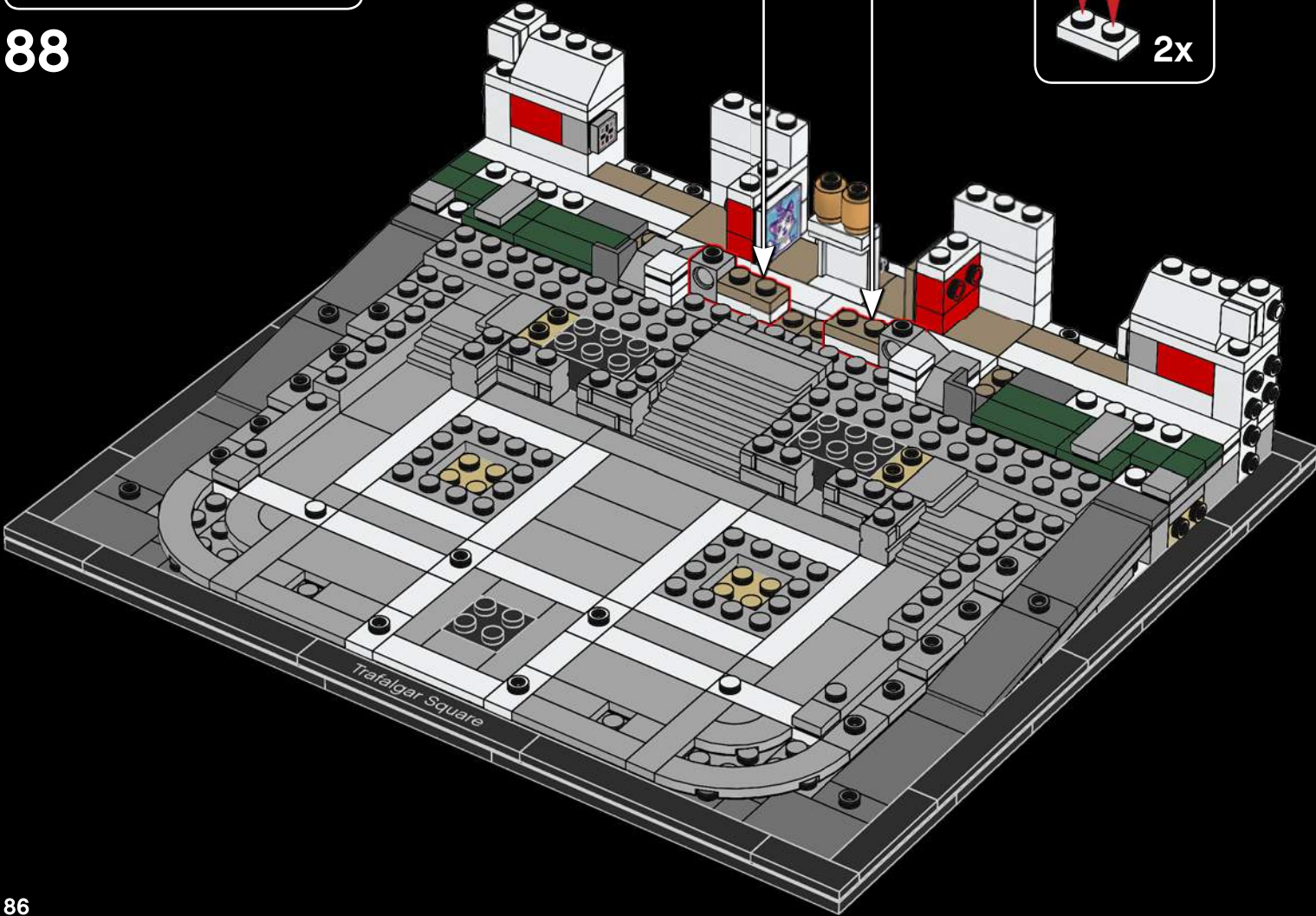
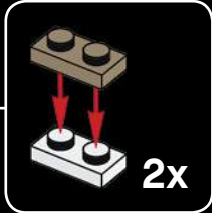

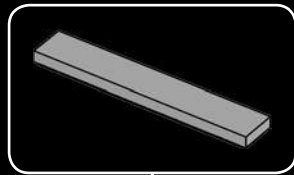
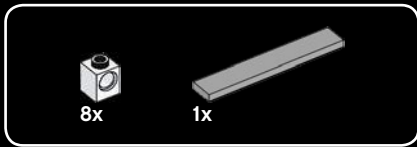

89

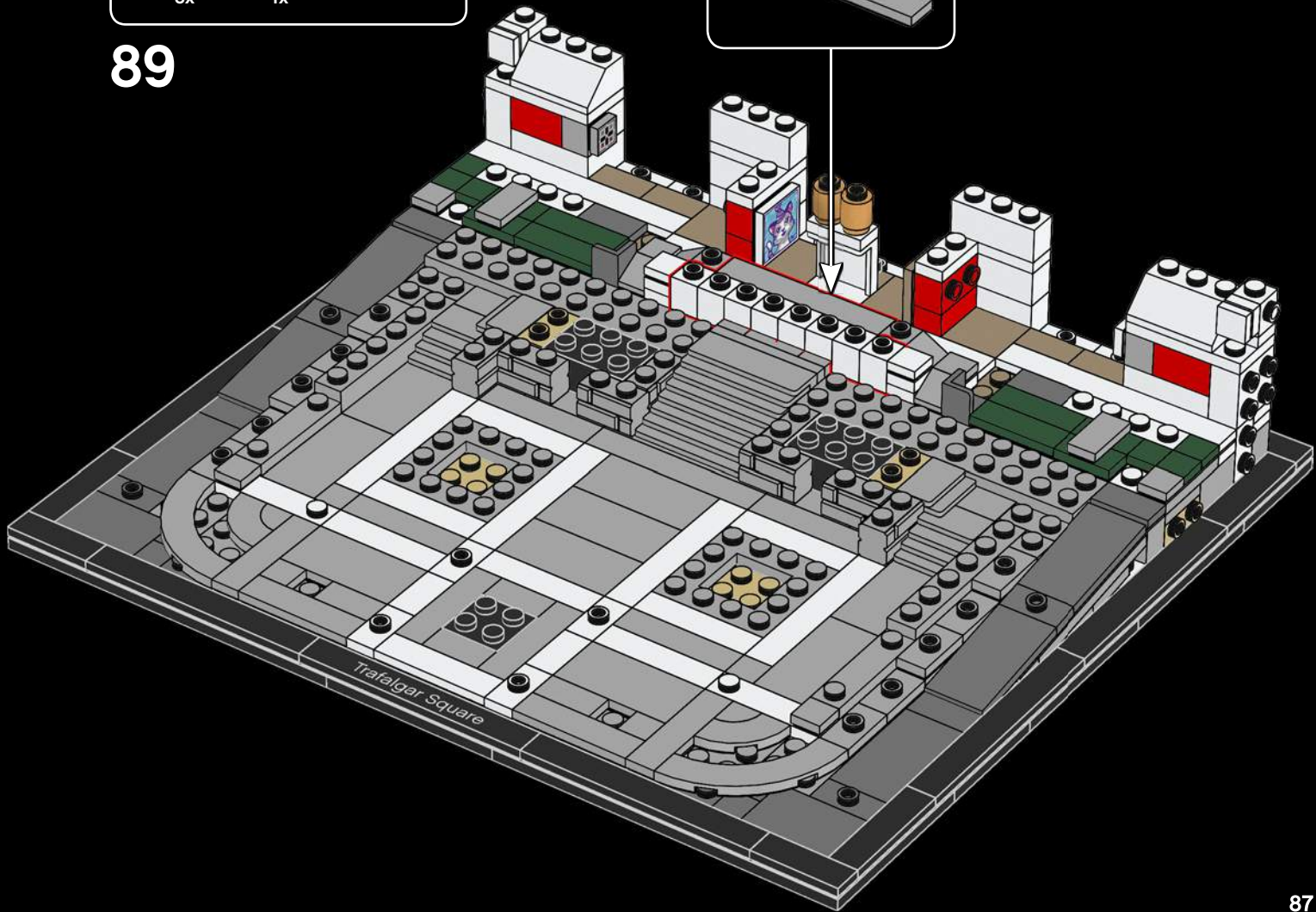

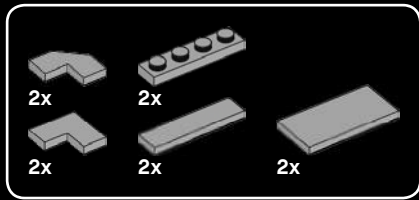

90

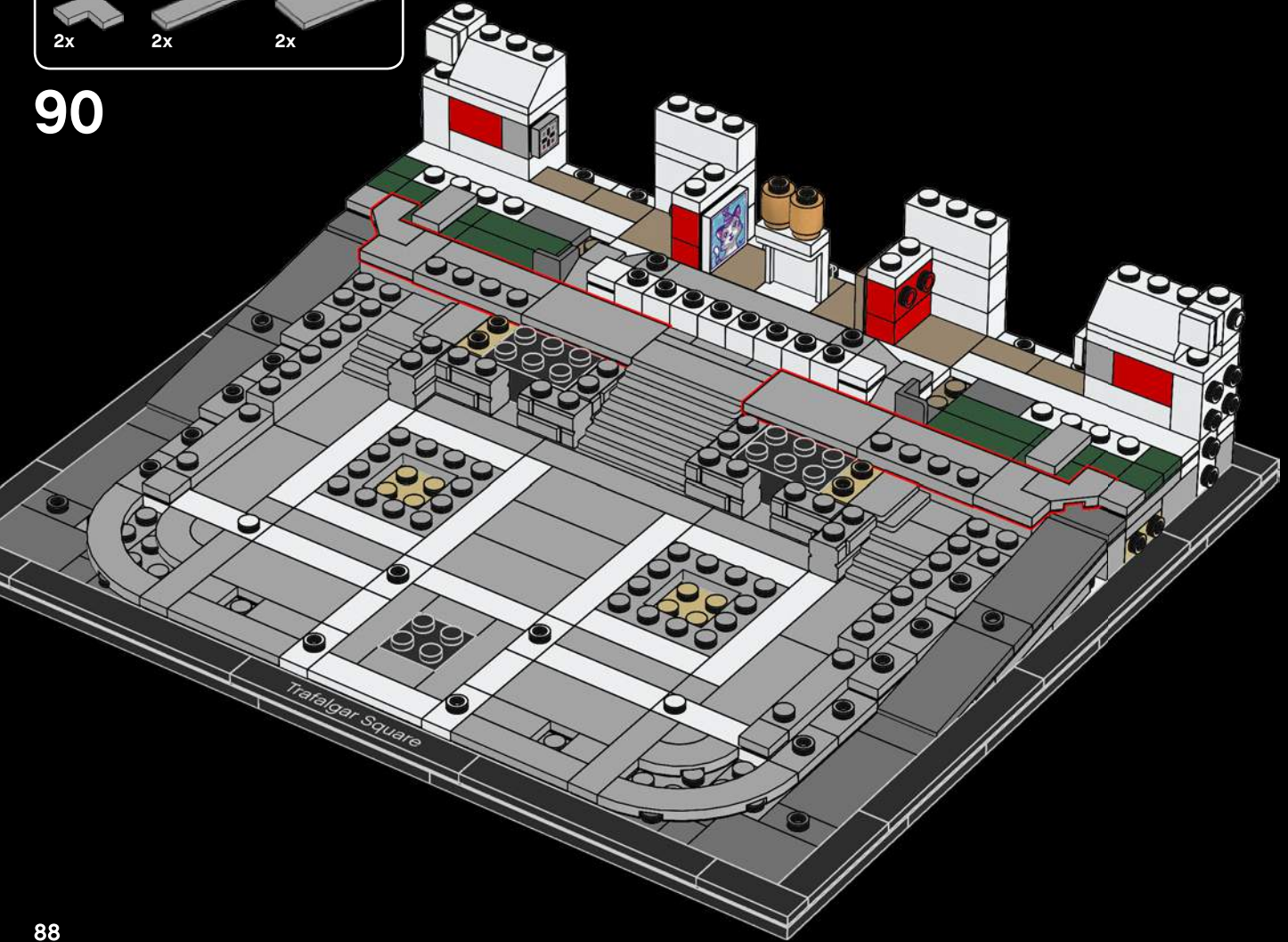





91

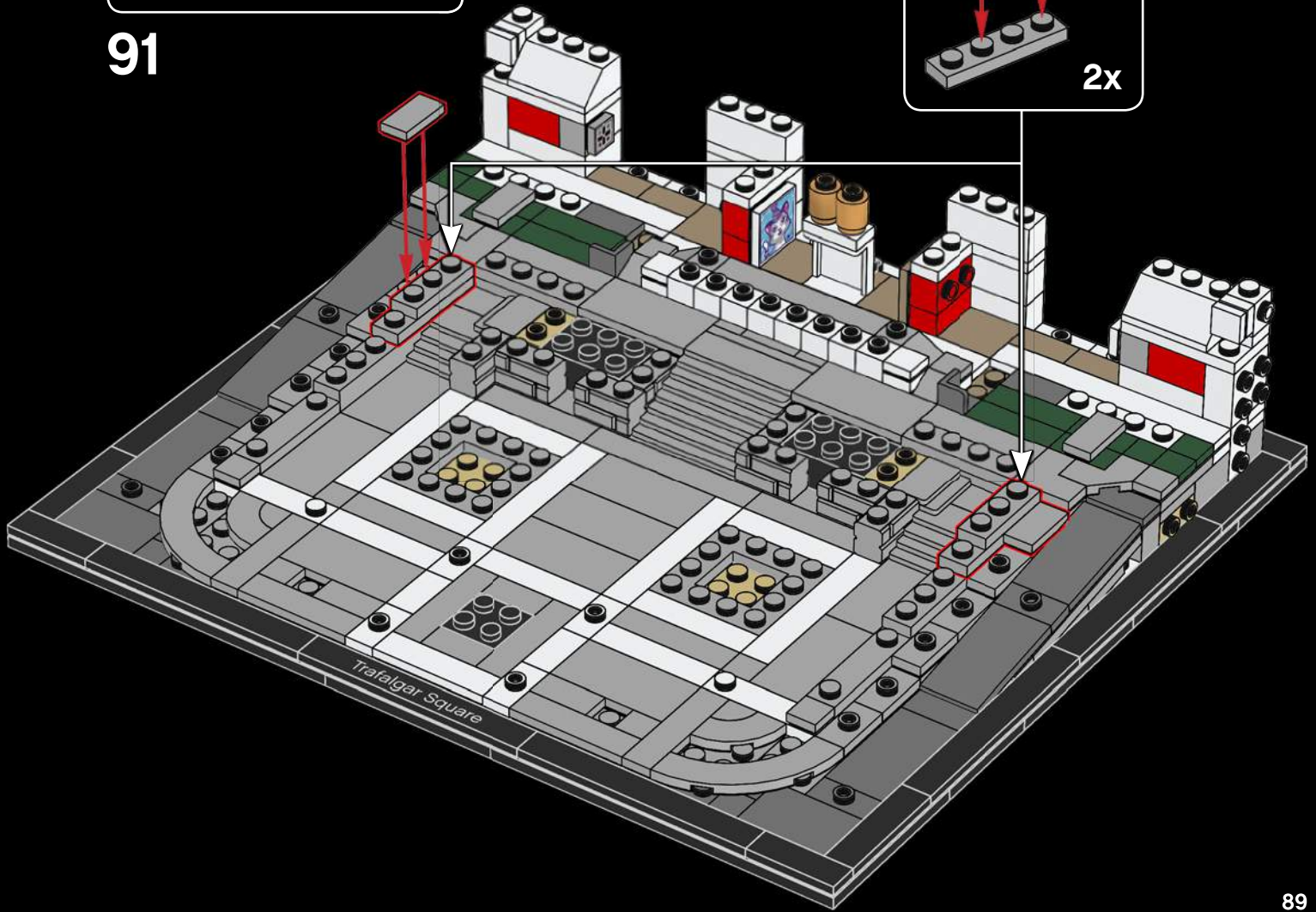
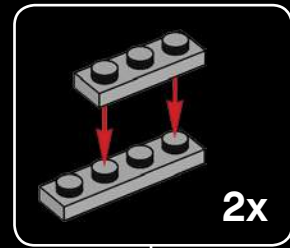

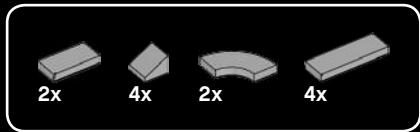

92

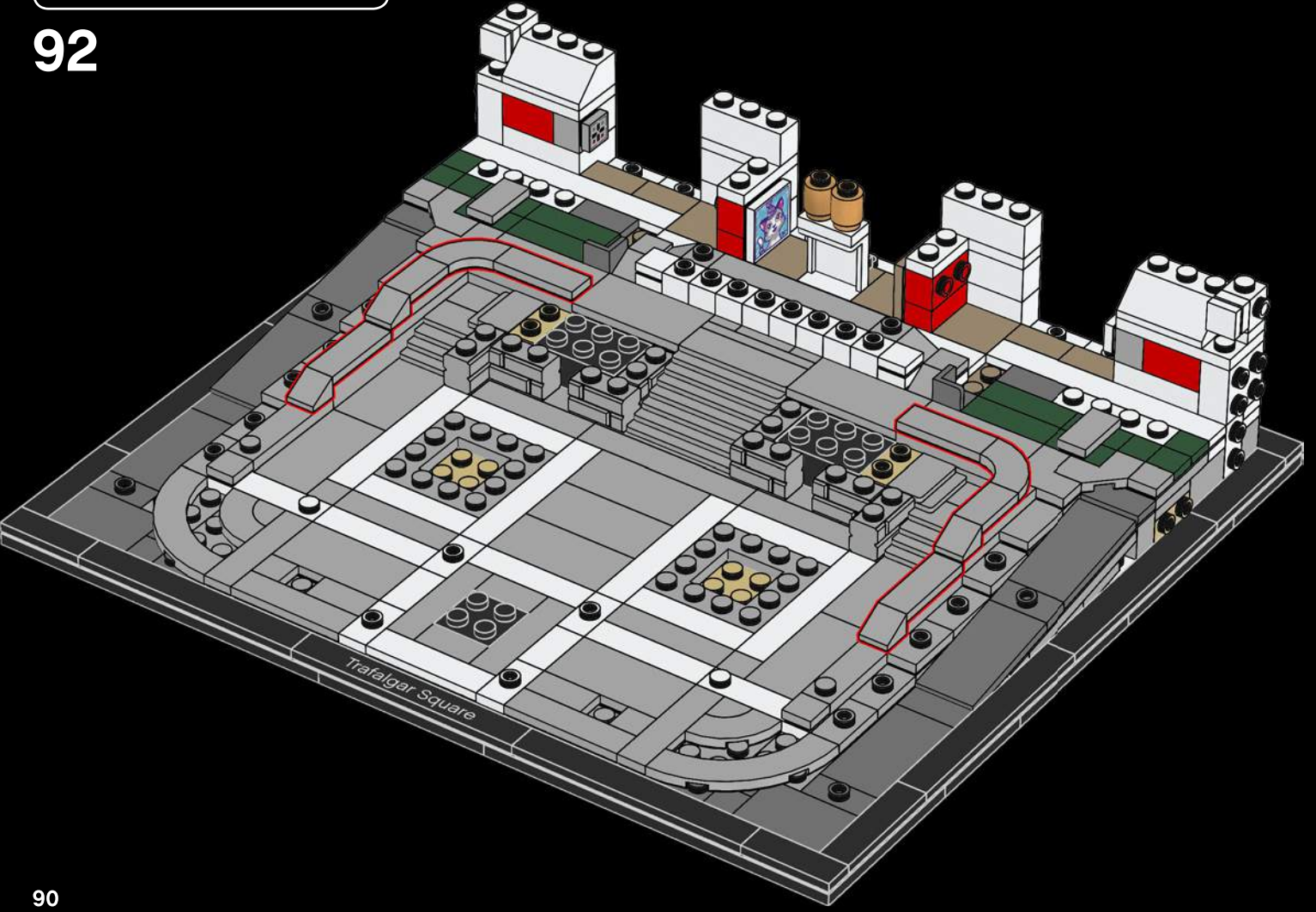



8x



8x

93

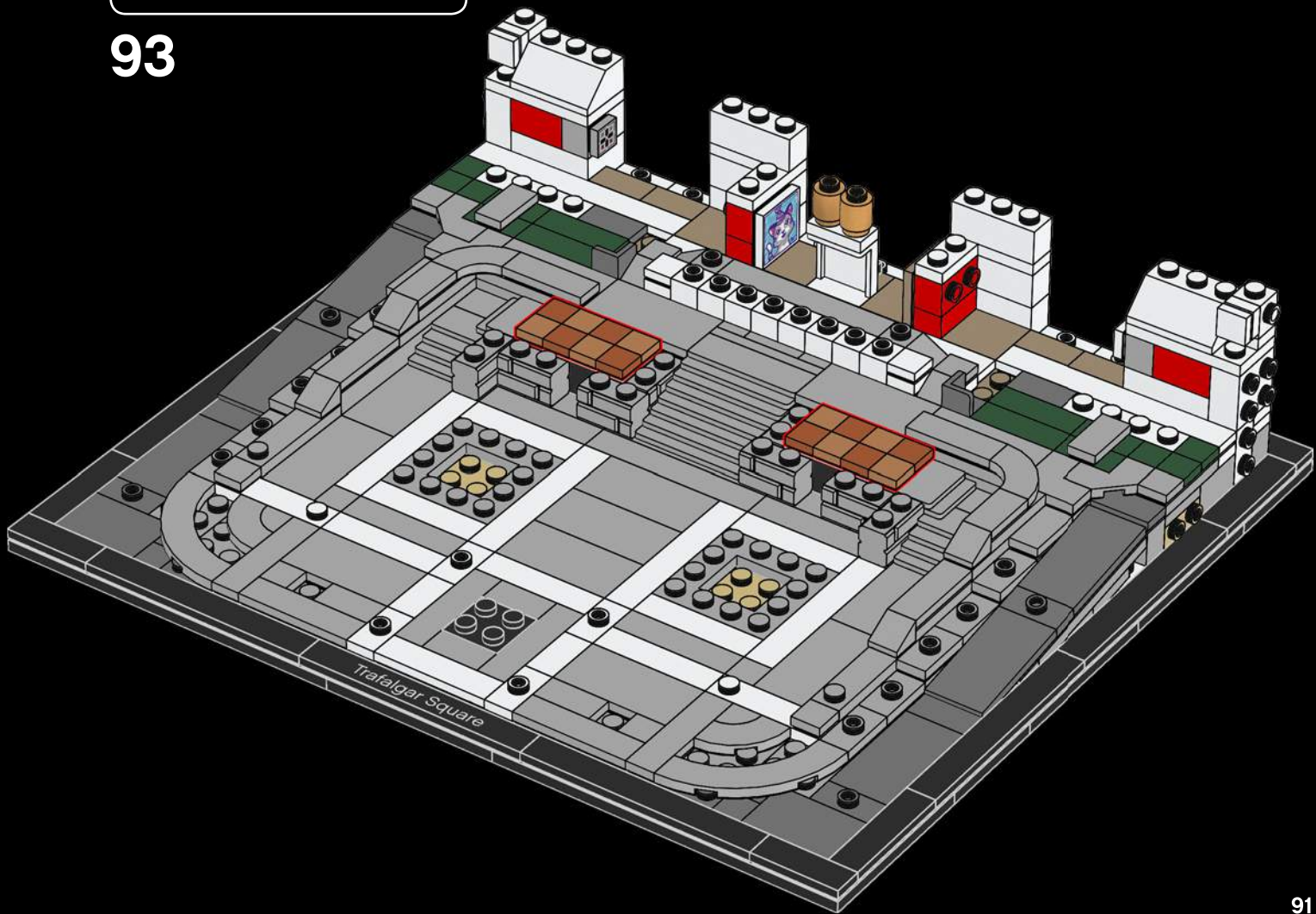

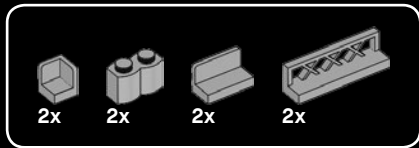

94

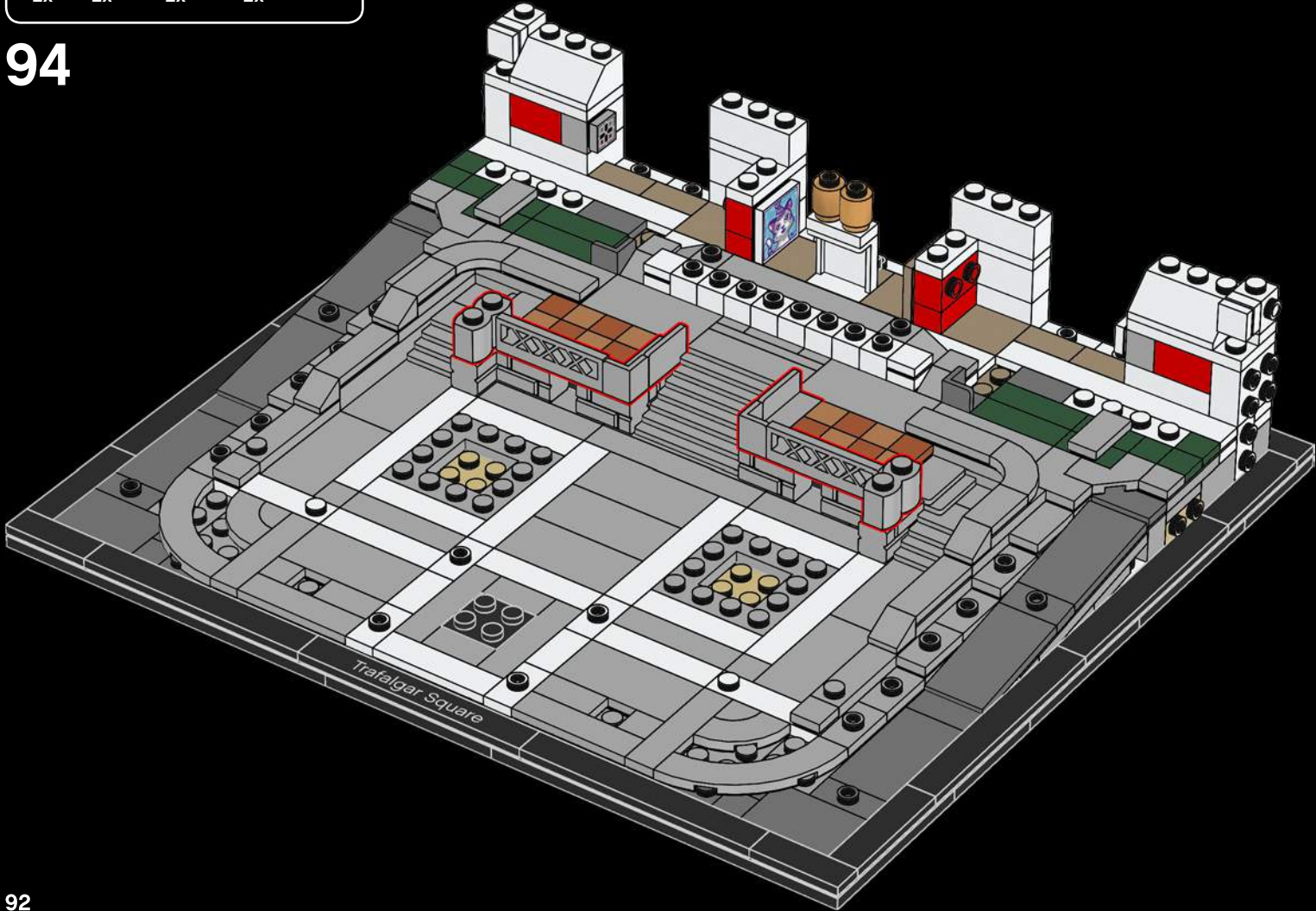

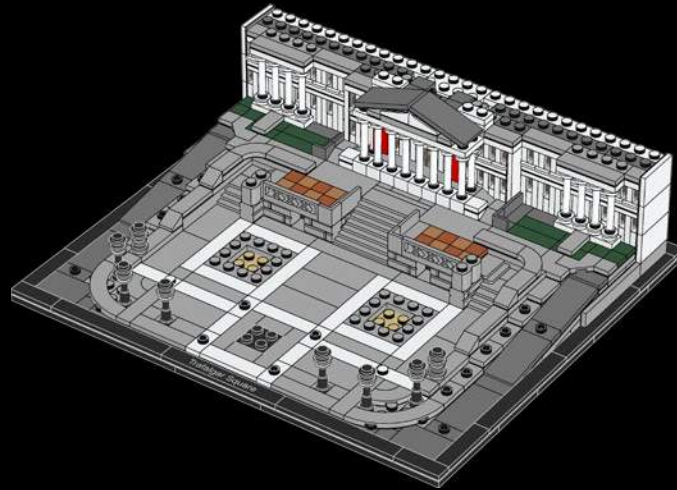



2x



2x



2x

95

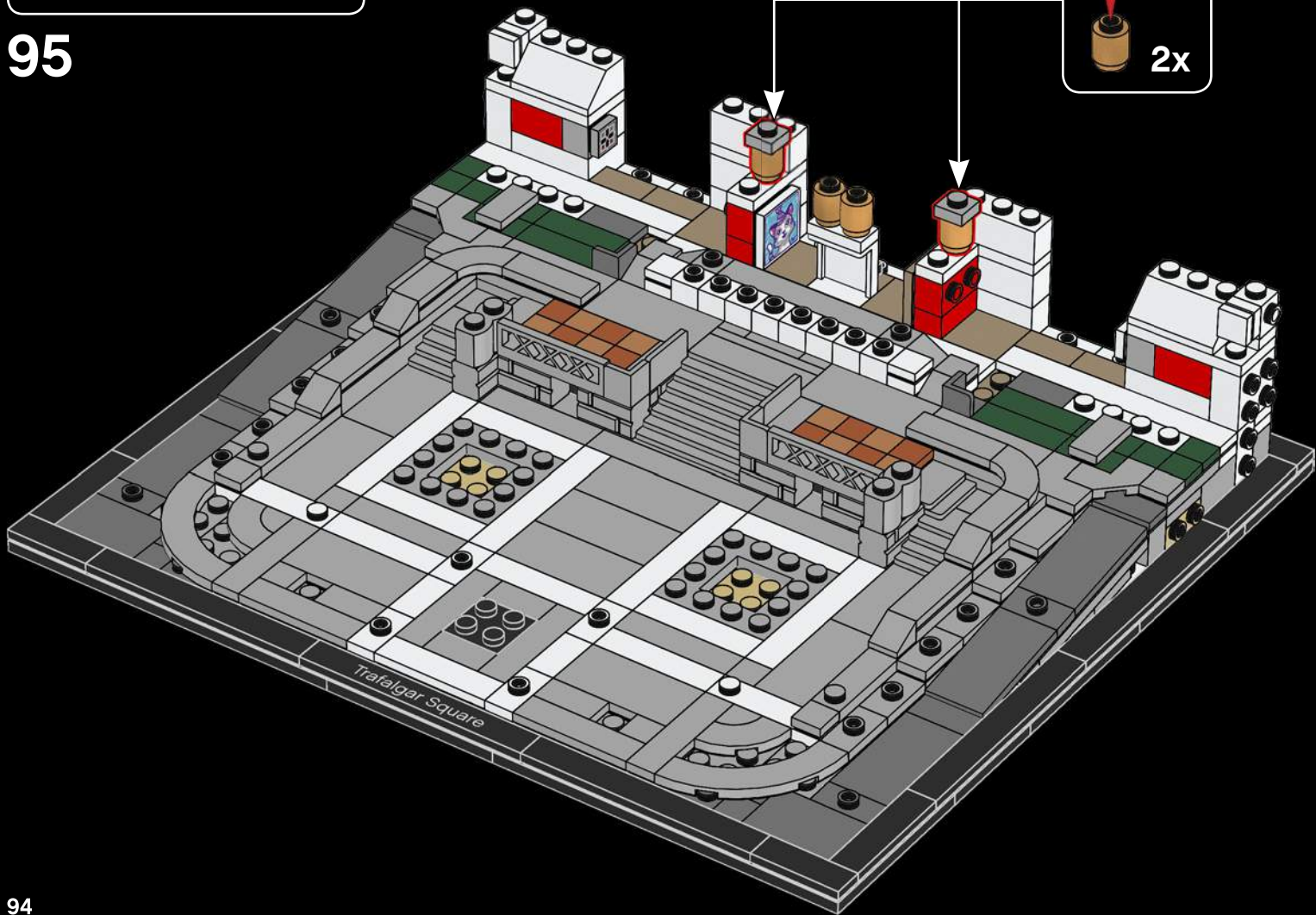

94

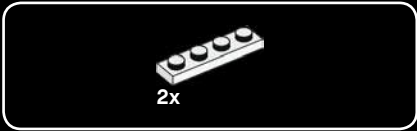
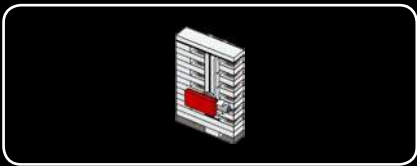

96

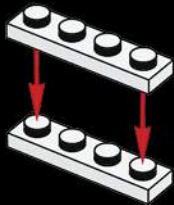

97

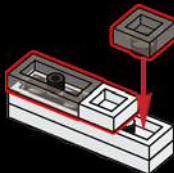

98

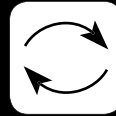

99

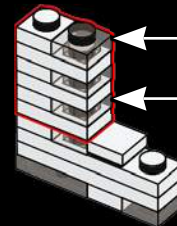
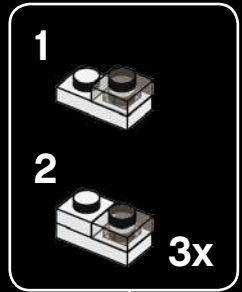

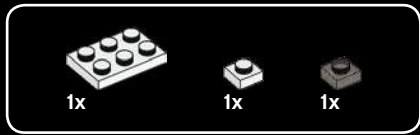

100

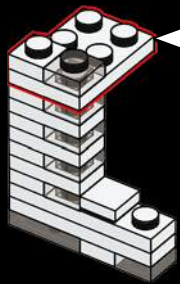
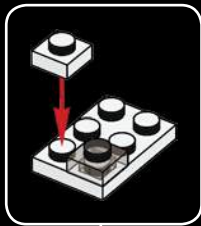

101

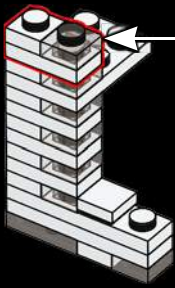
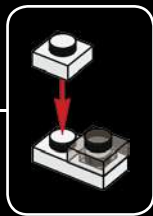

102

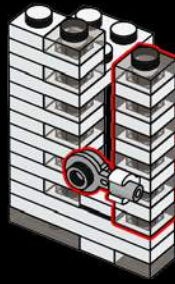
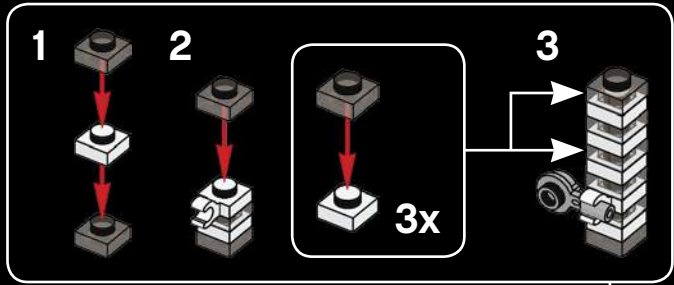



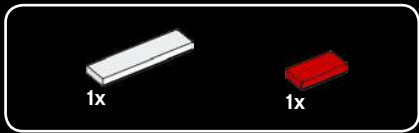

103

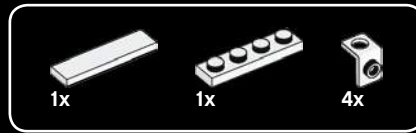
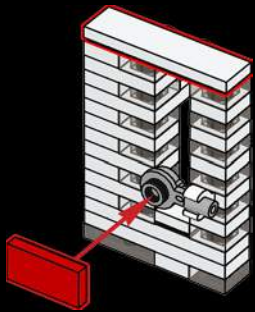

104

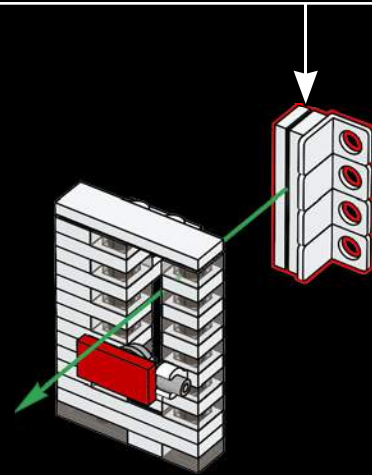
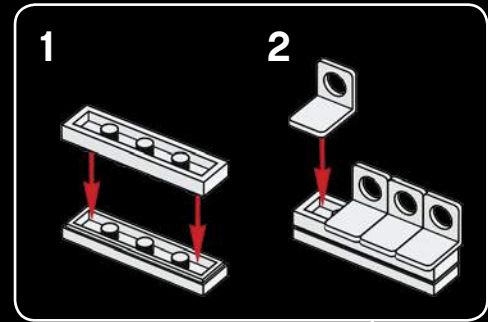

105

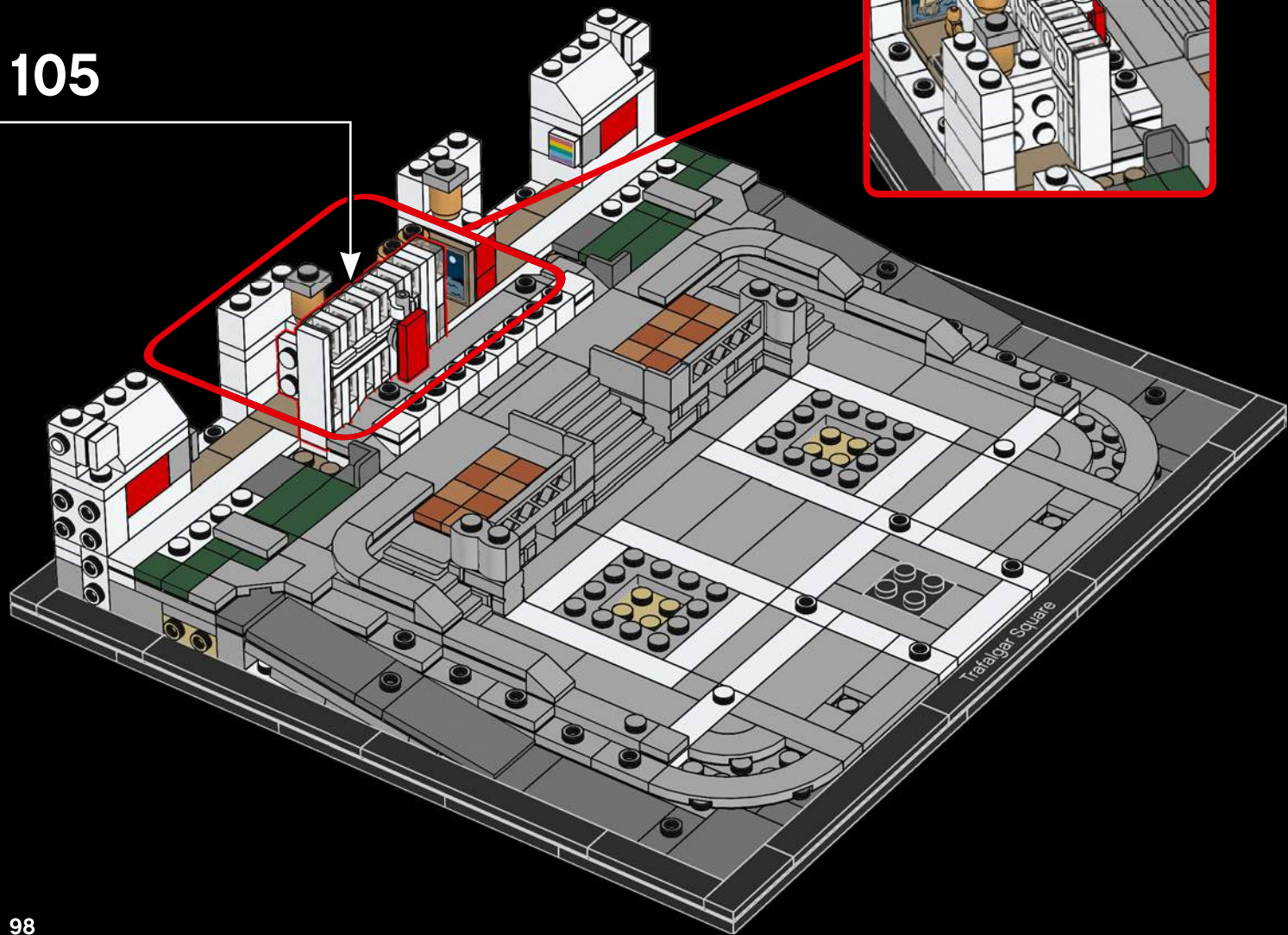

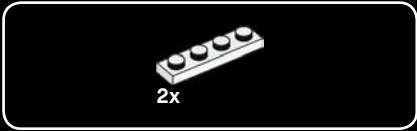
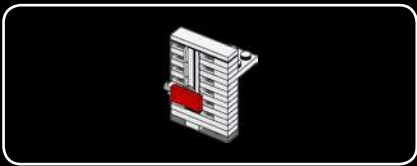

106

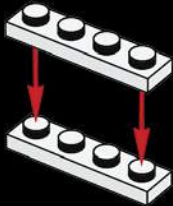

107

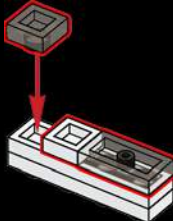

108

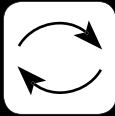

109

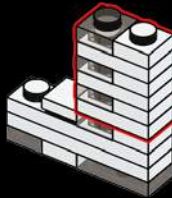
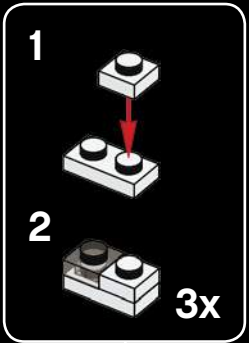

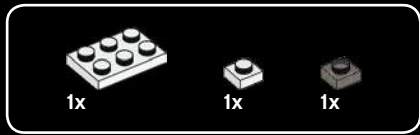

110

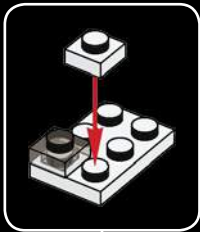

111

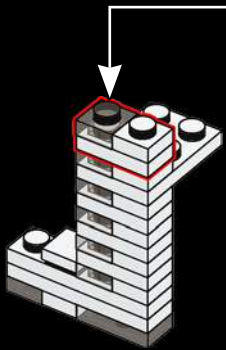
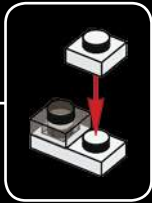

112

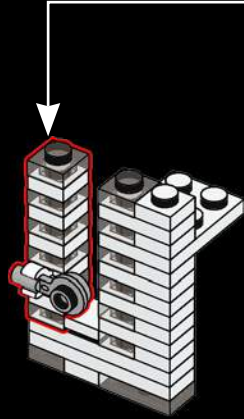
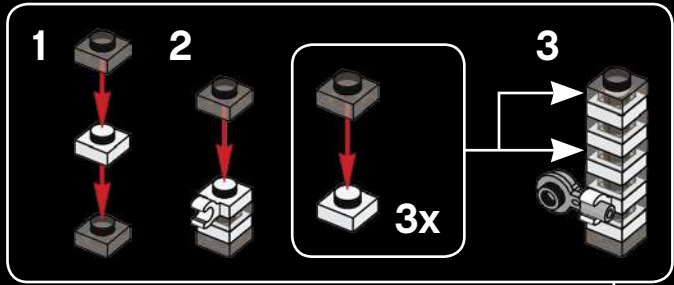

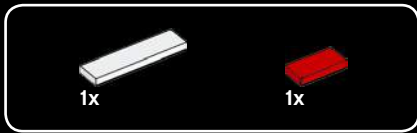

113

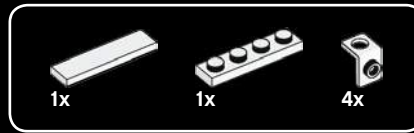
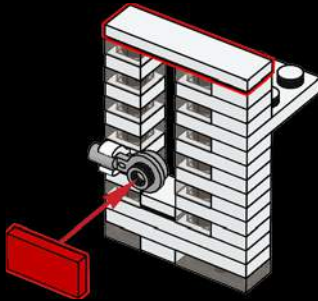

114

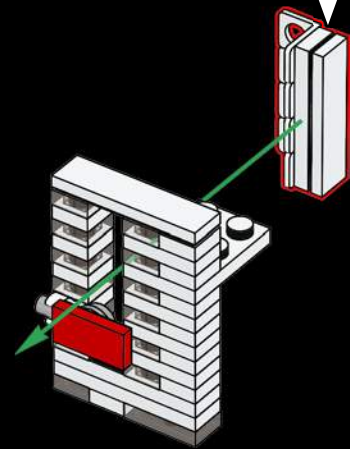
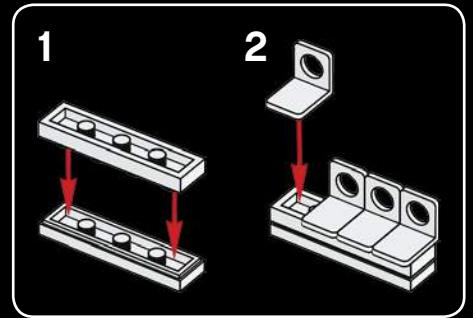

115

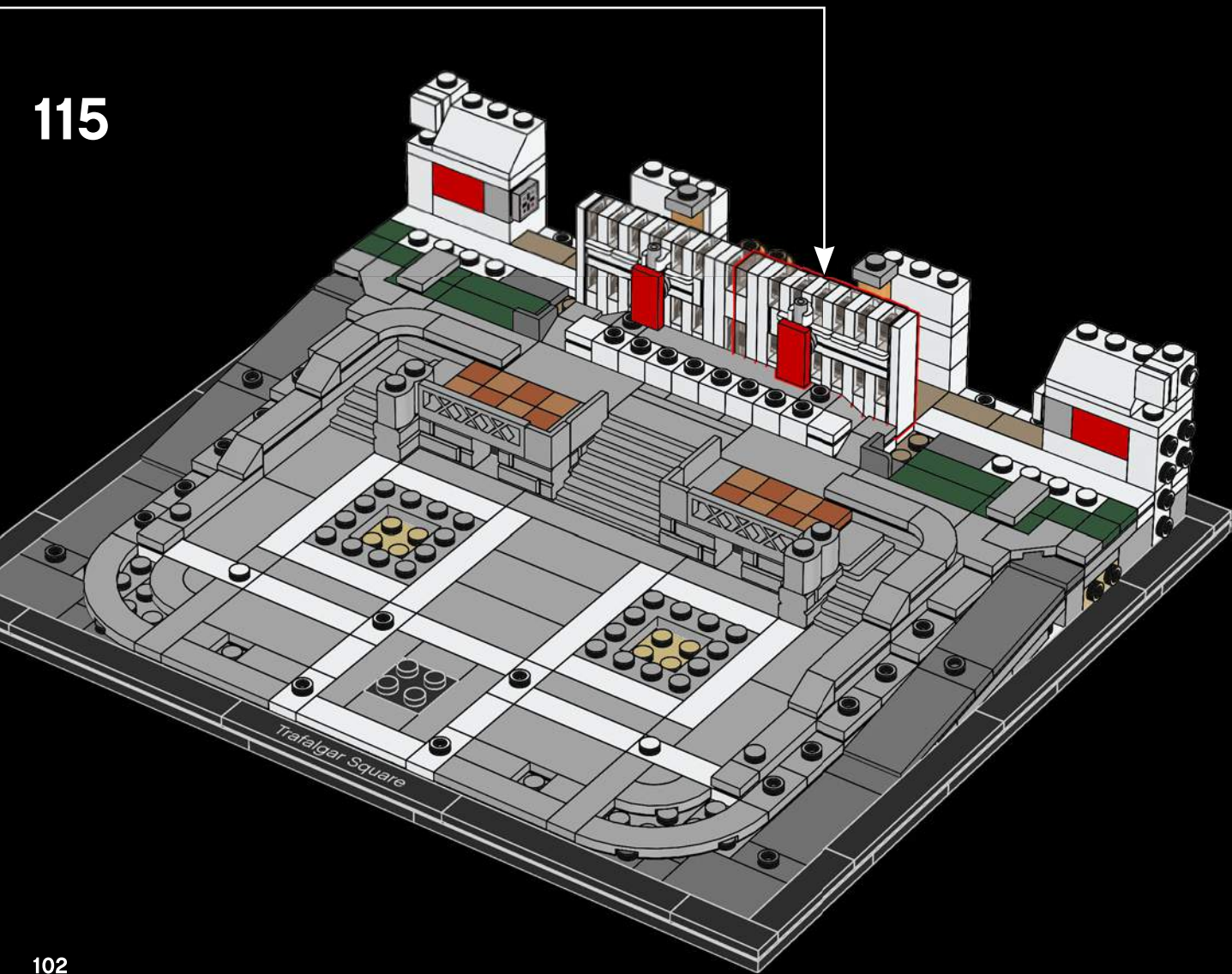



116

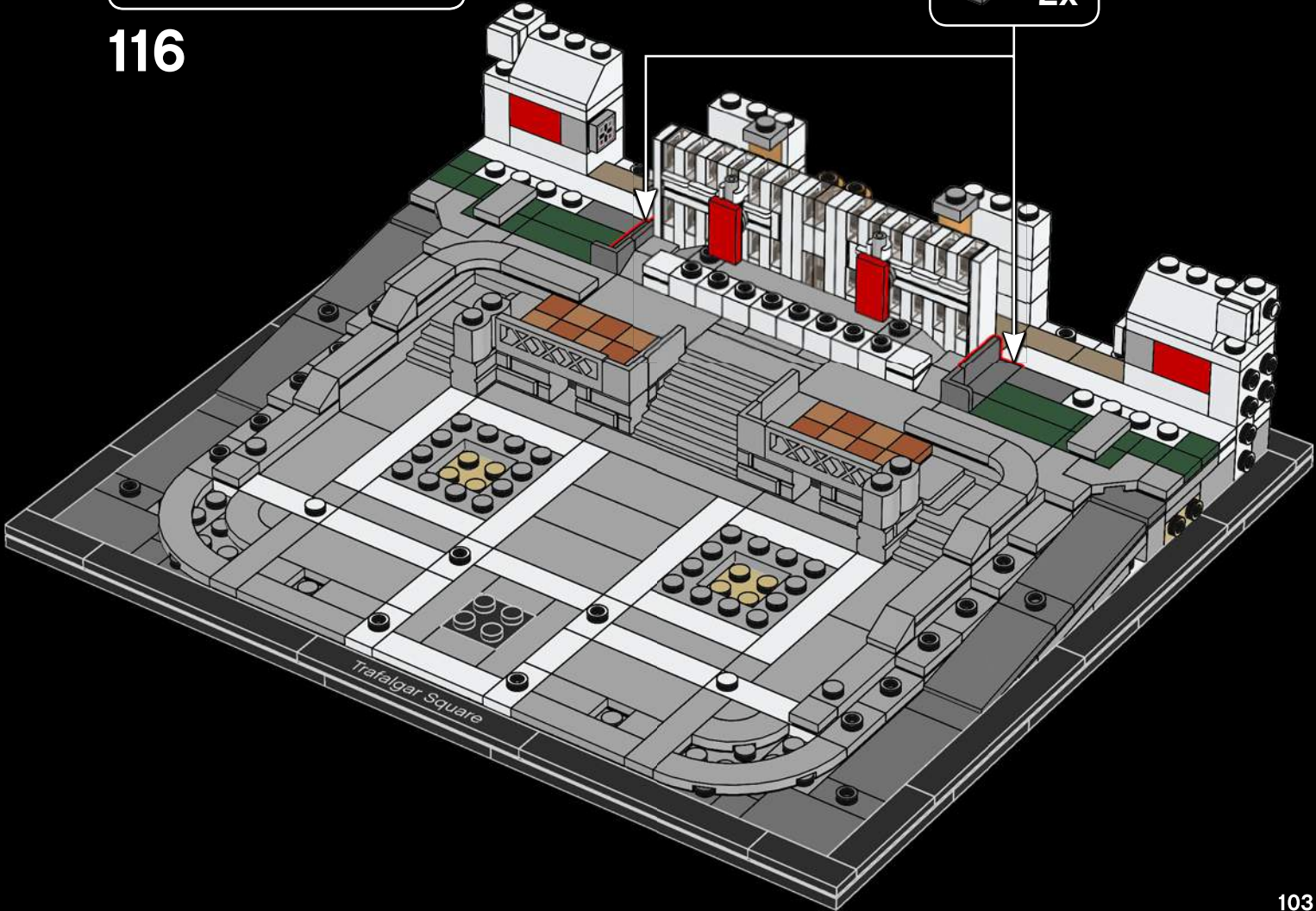
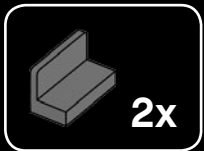

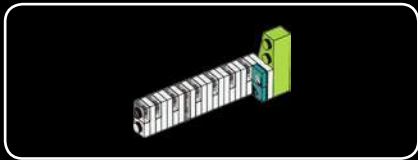

117

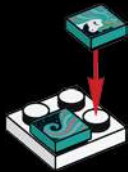

118

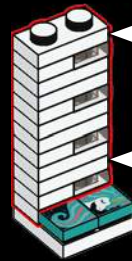
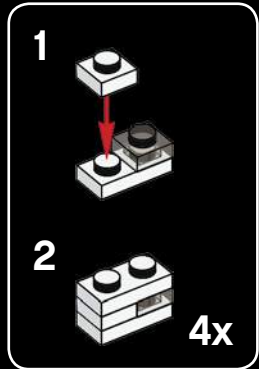





119

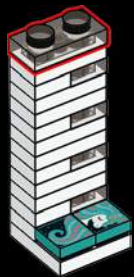

120

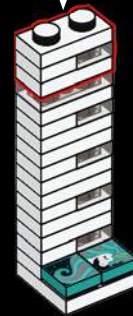
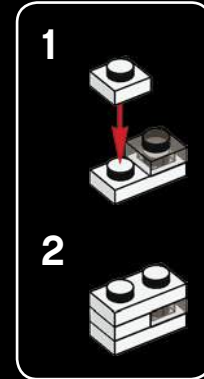



# 121

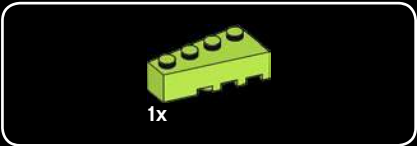
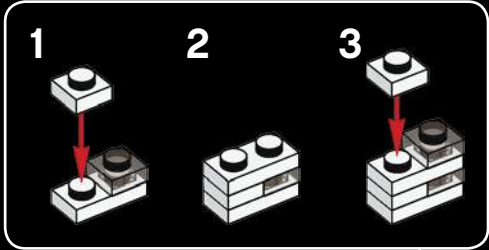

# 122

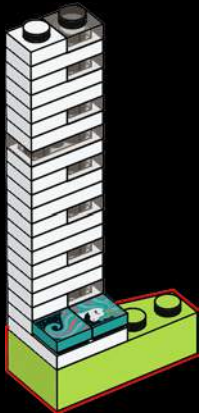

123

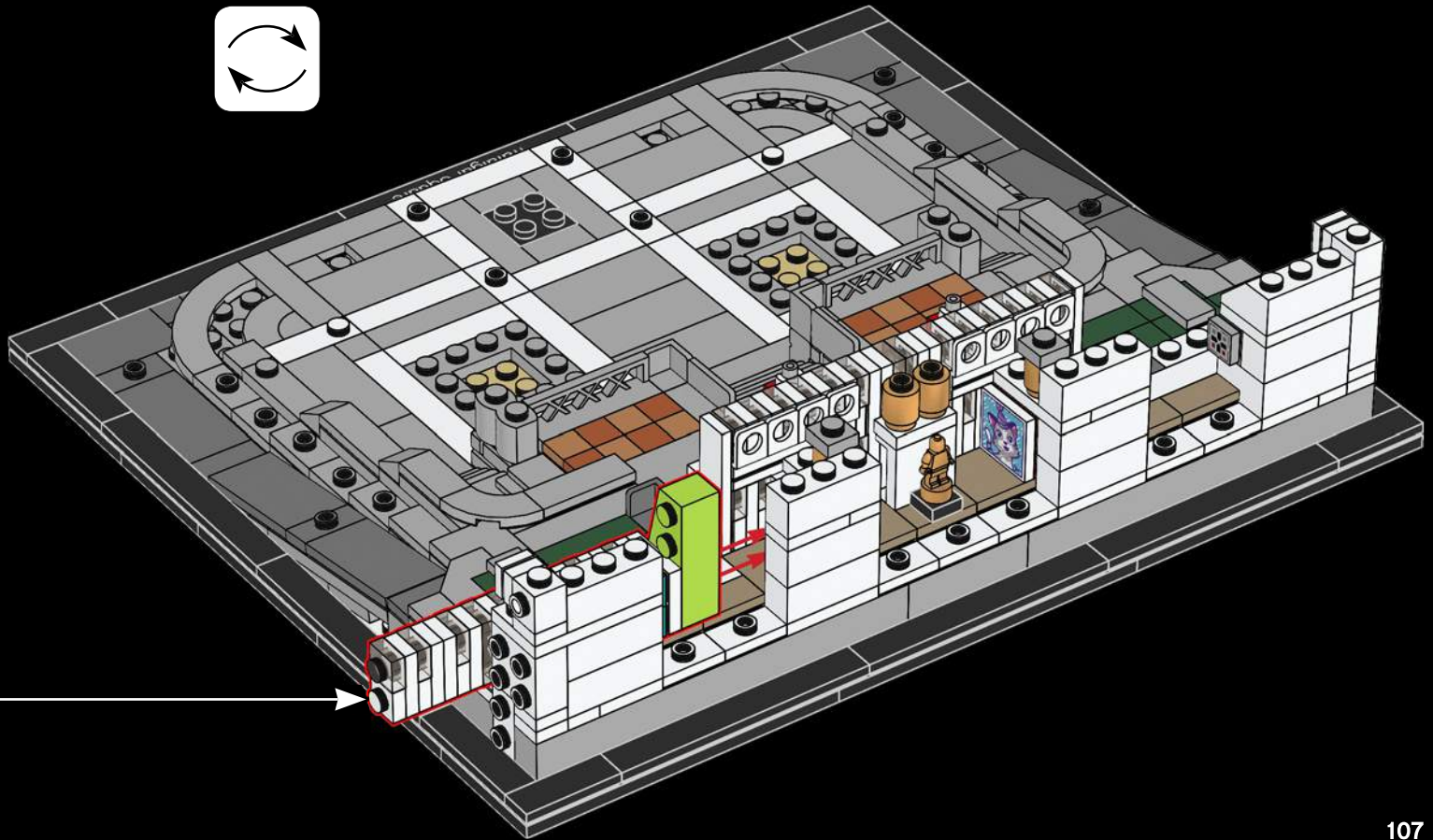

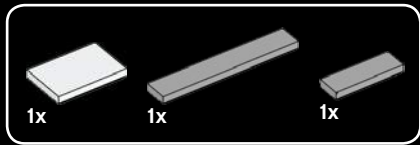

124

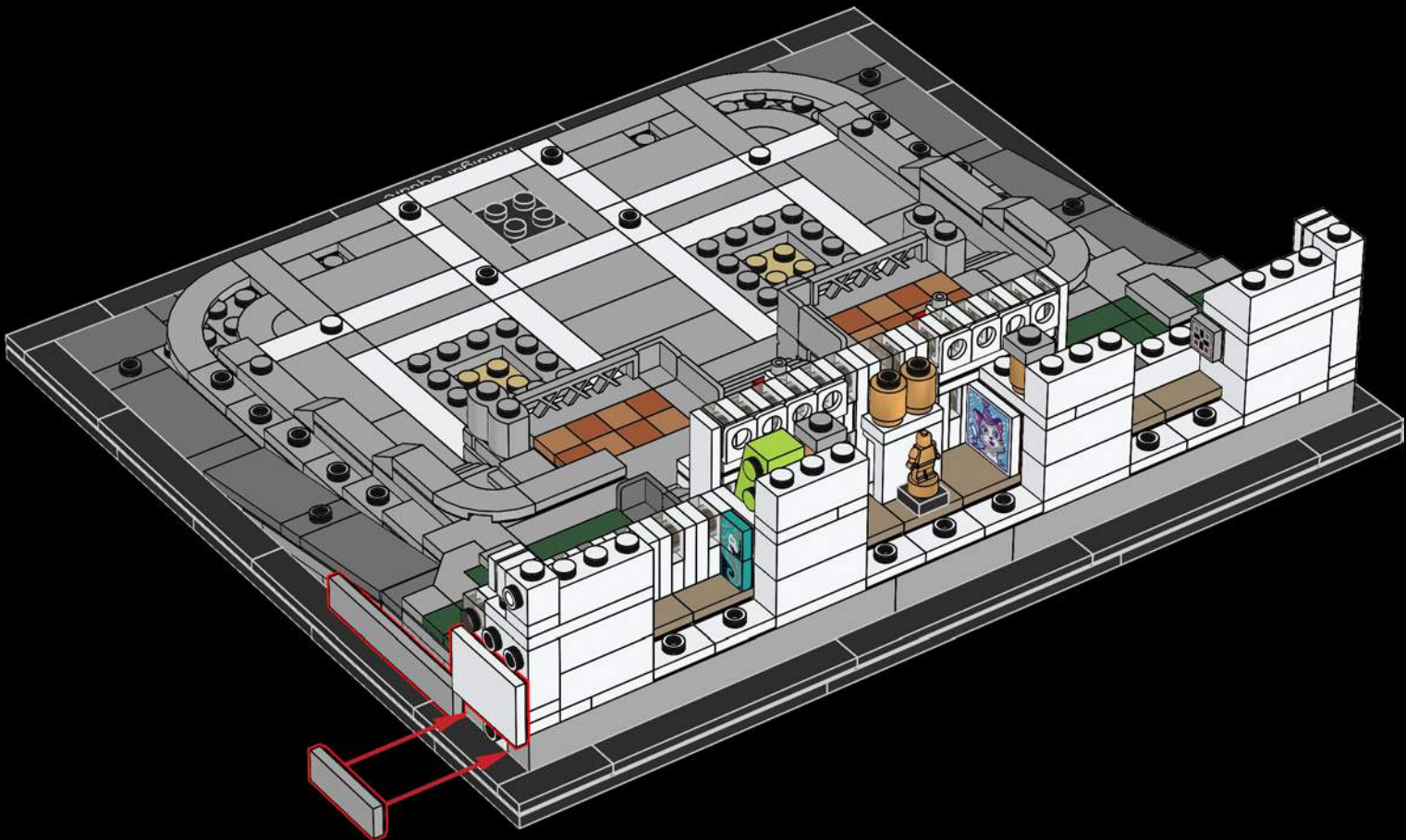

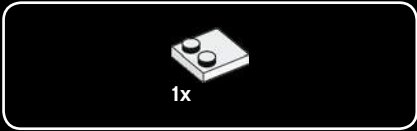
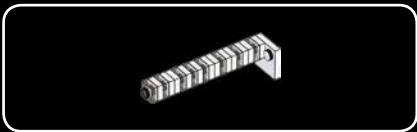

125



126

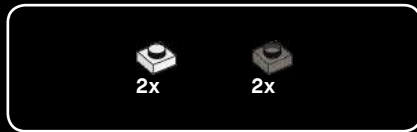
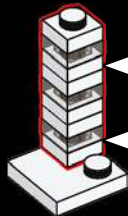
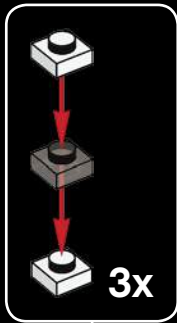

127

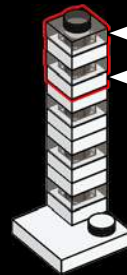
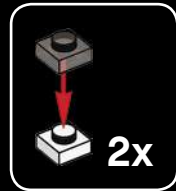



2x



1x

128



2x



2x

129

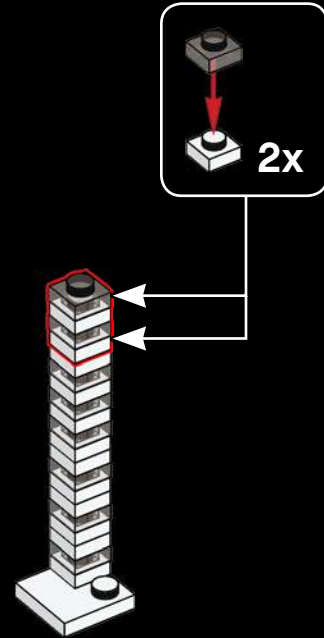

130

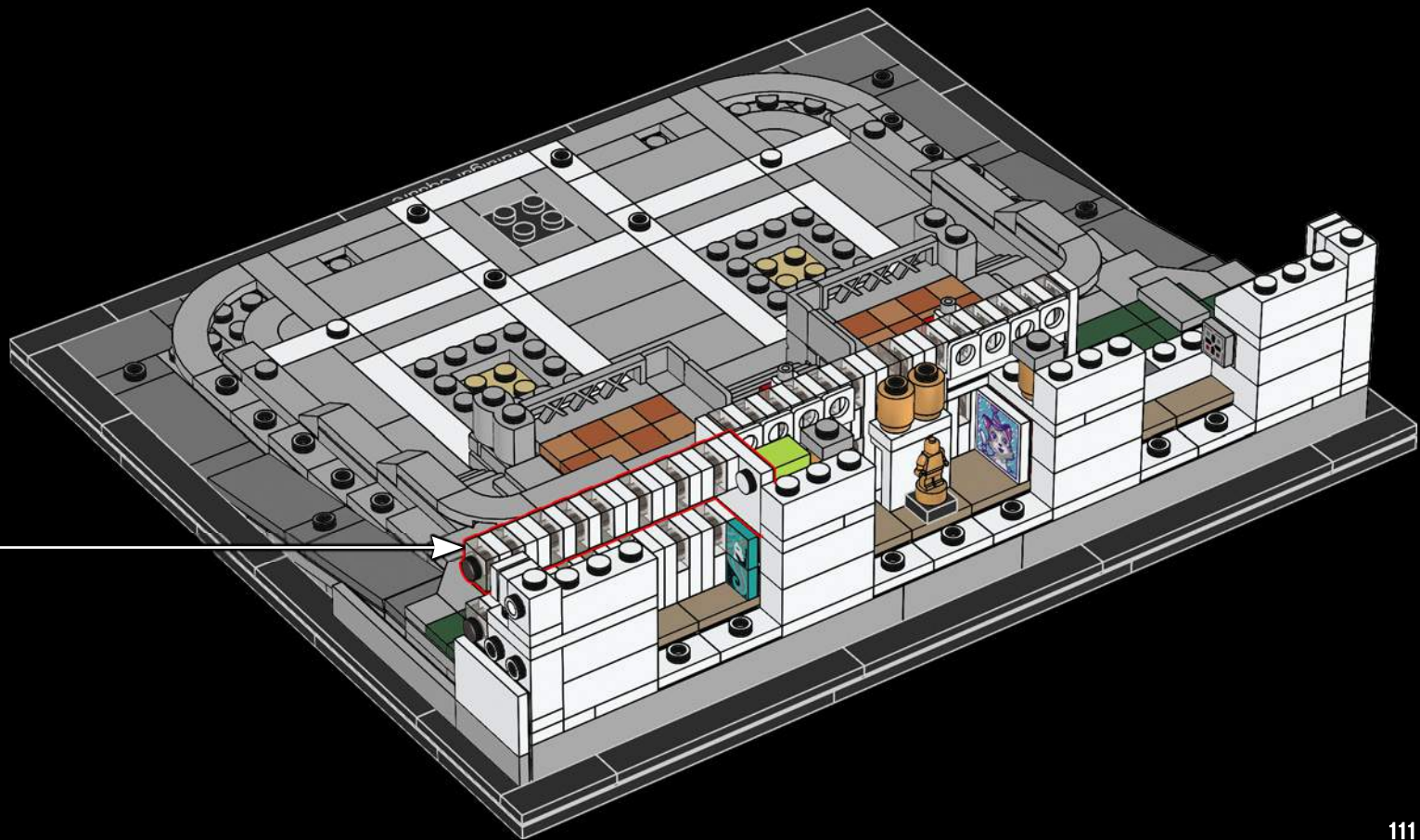

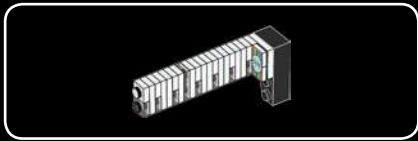

131

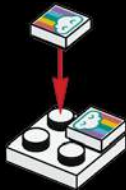

132

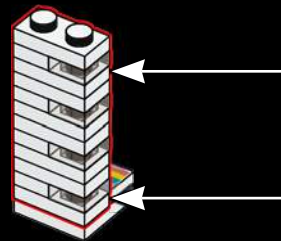
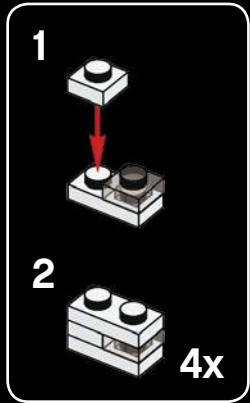





133



134

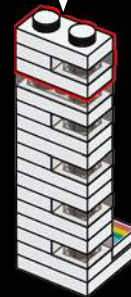
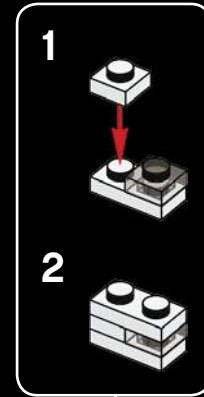



# 135

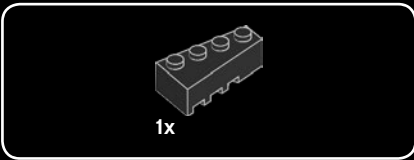
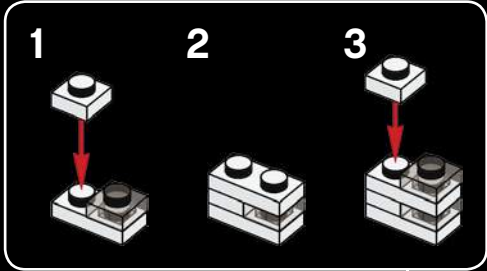

# 136

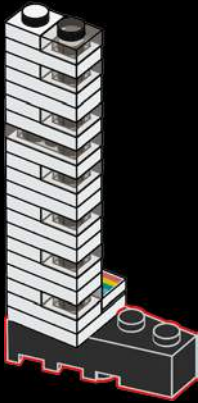

137

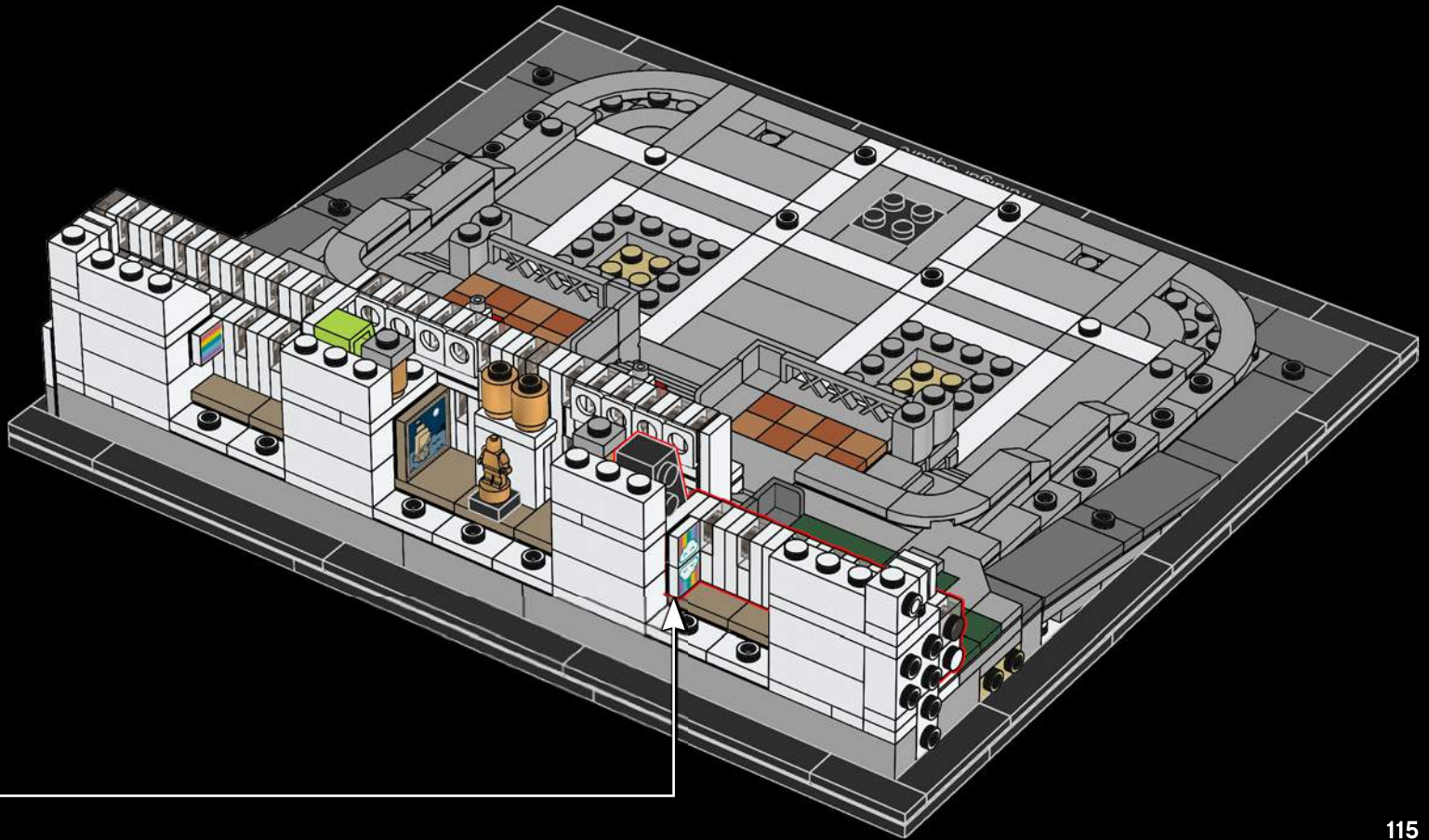

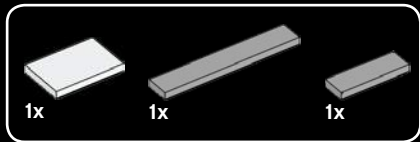

138

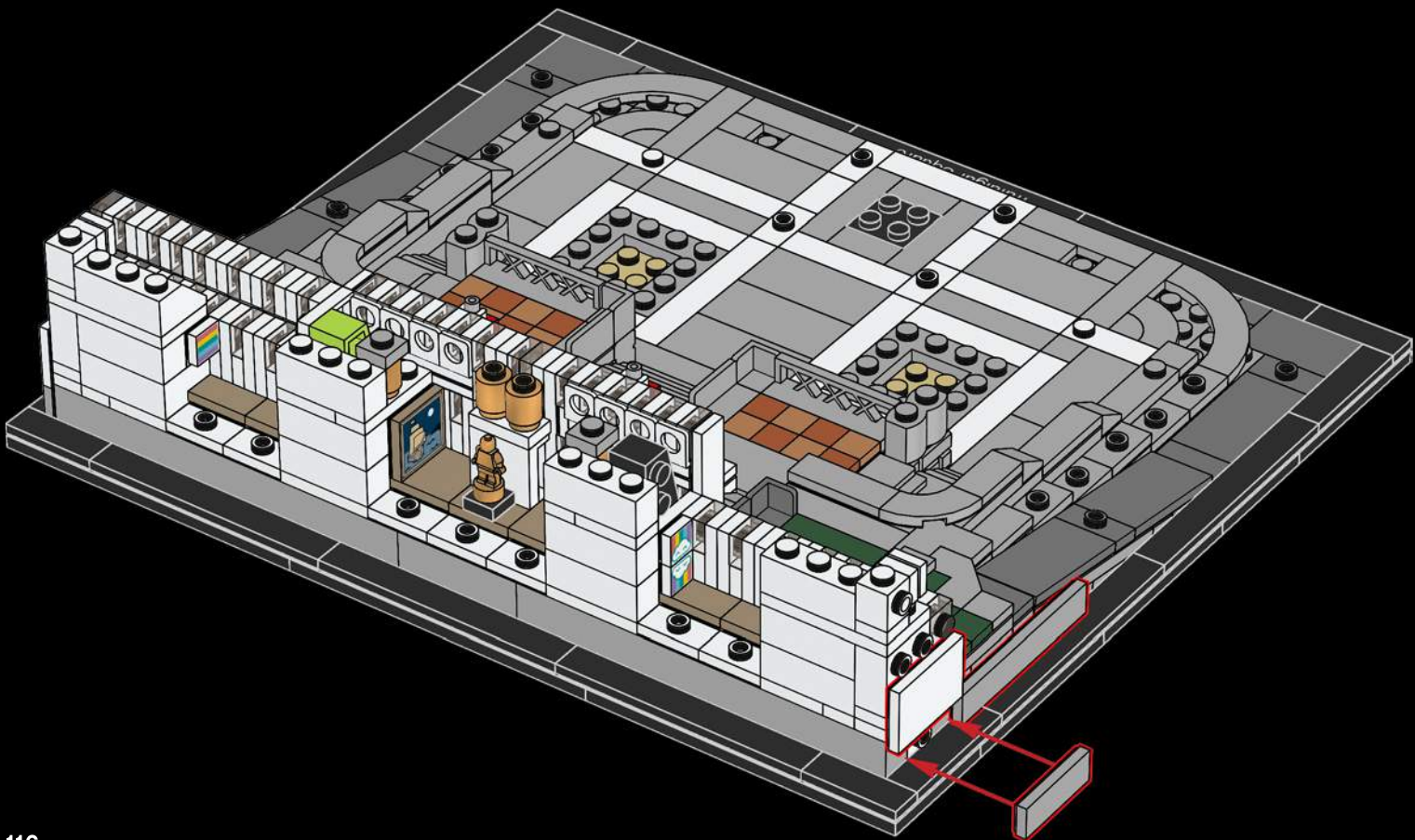



139



140

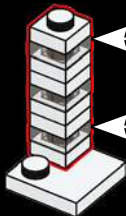
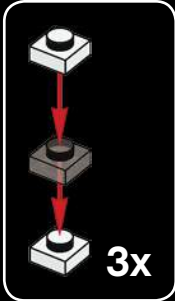

141

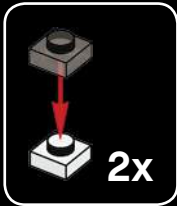



2x



1x

142

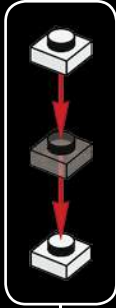

2x



2x

143

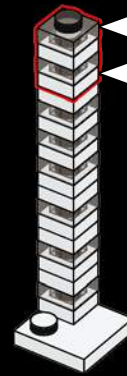
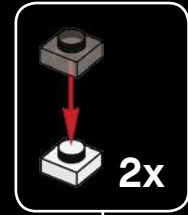

144

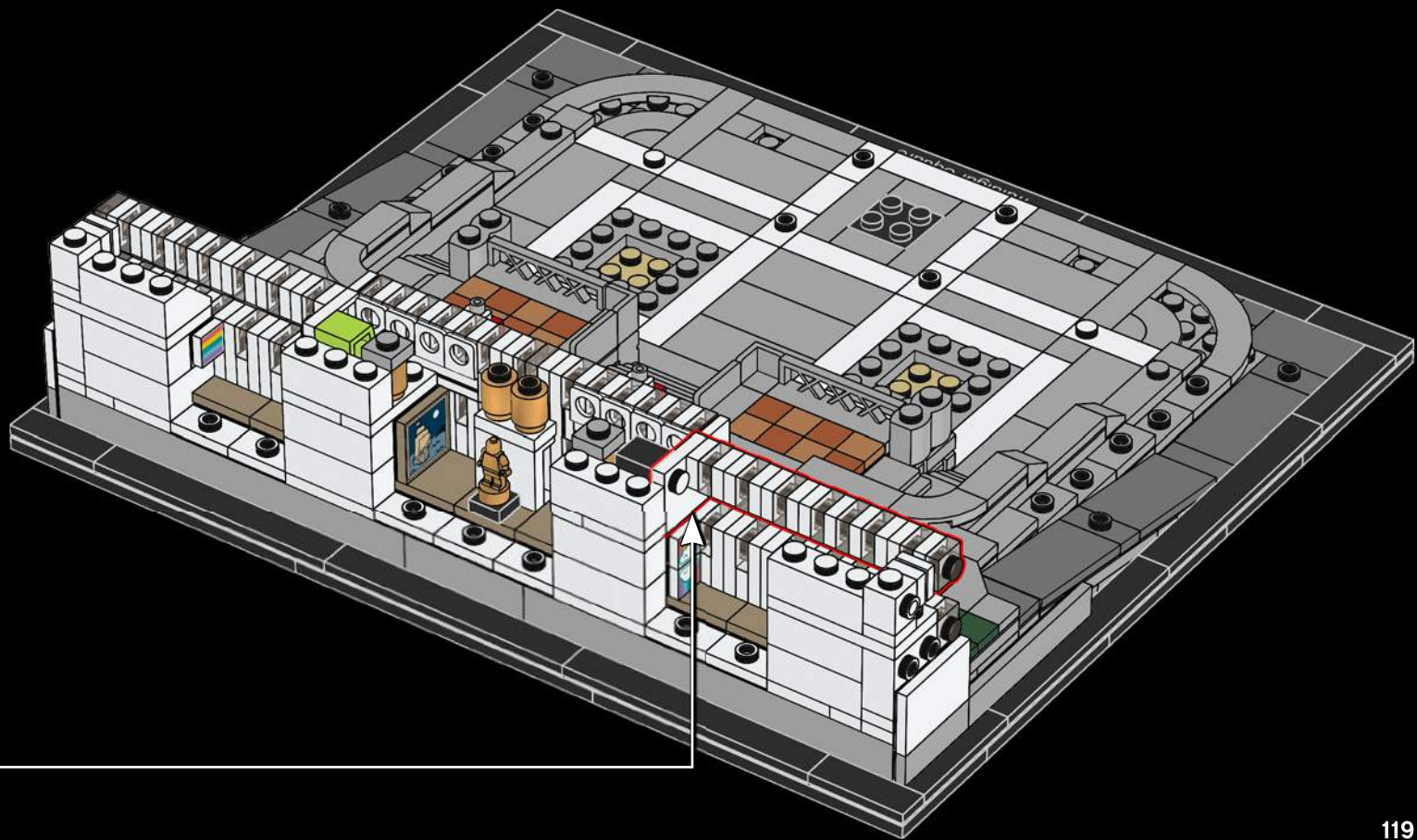

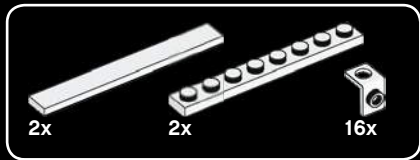

145

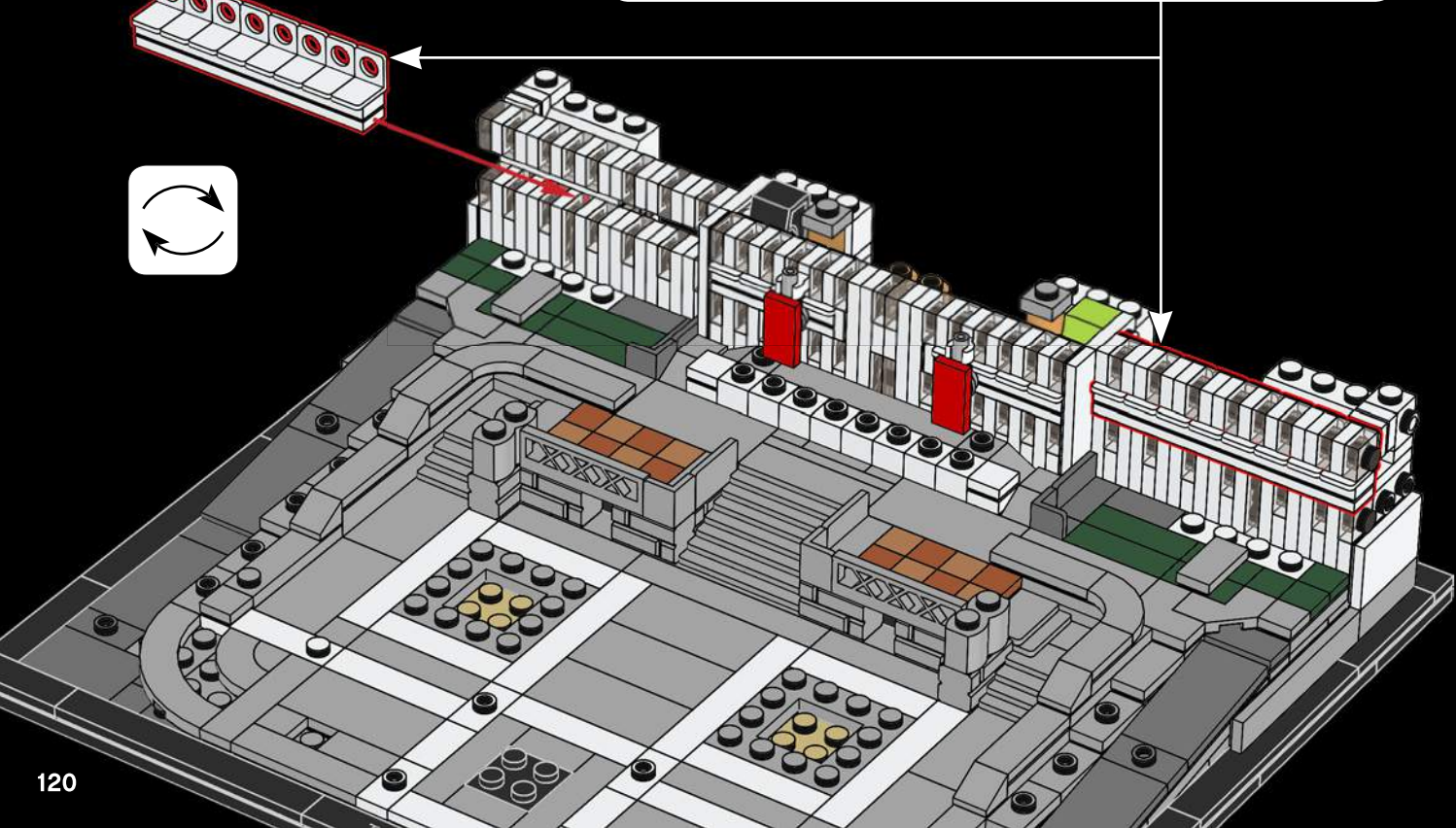
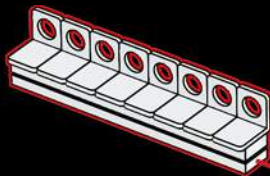
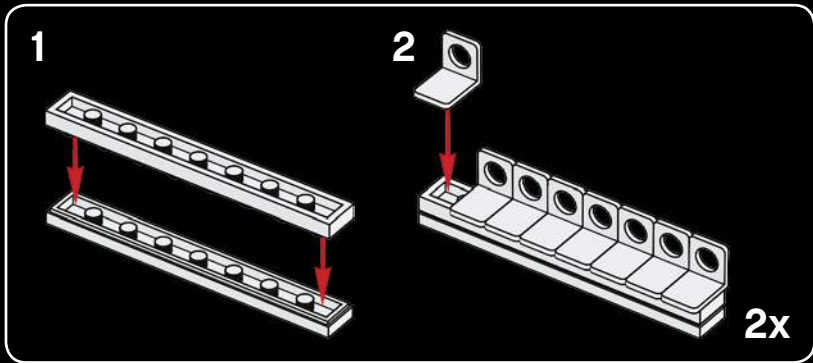





146

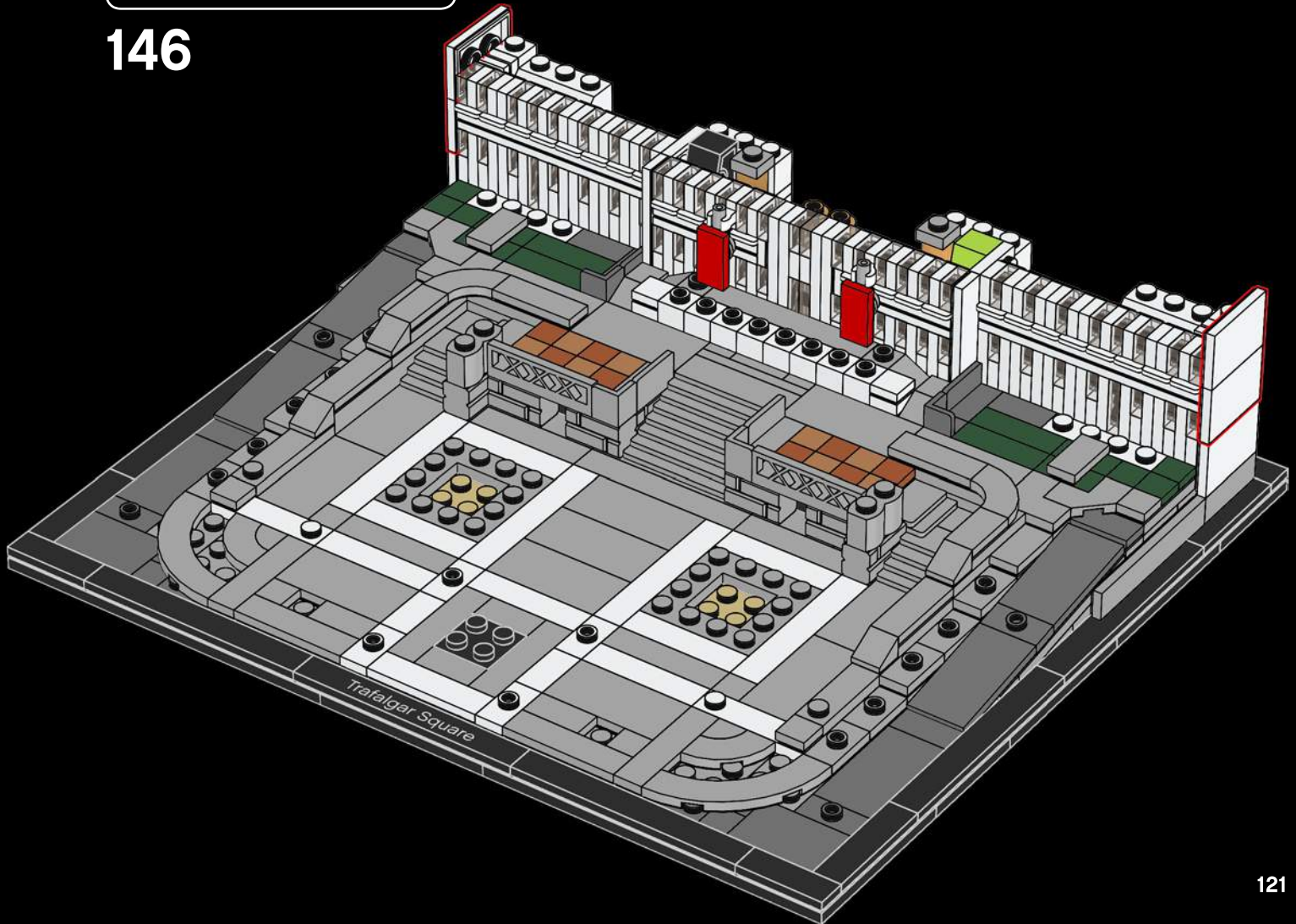

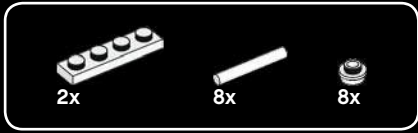

147

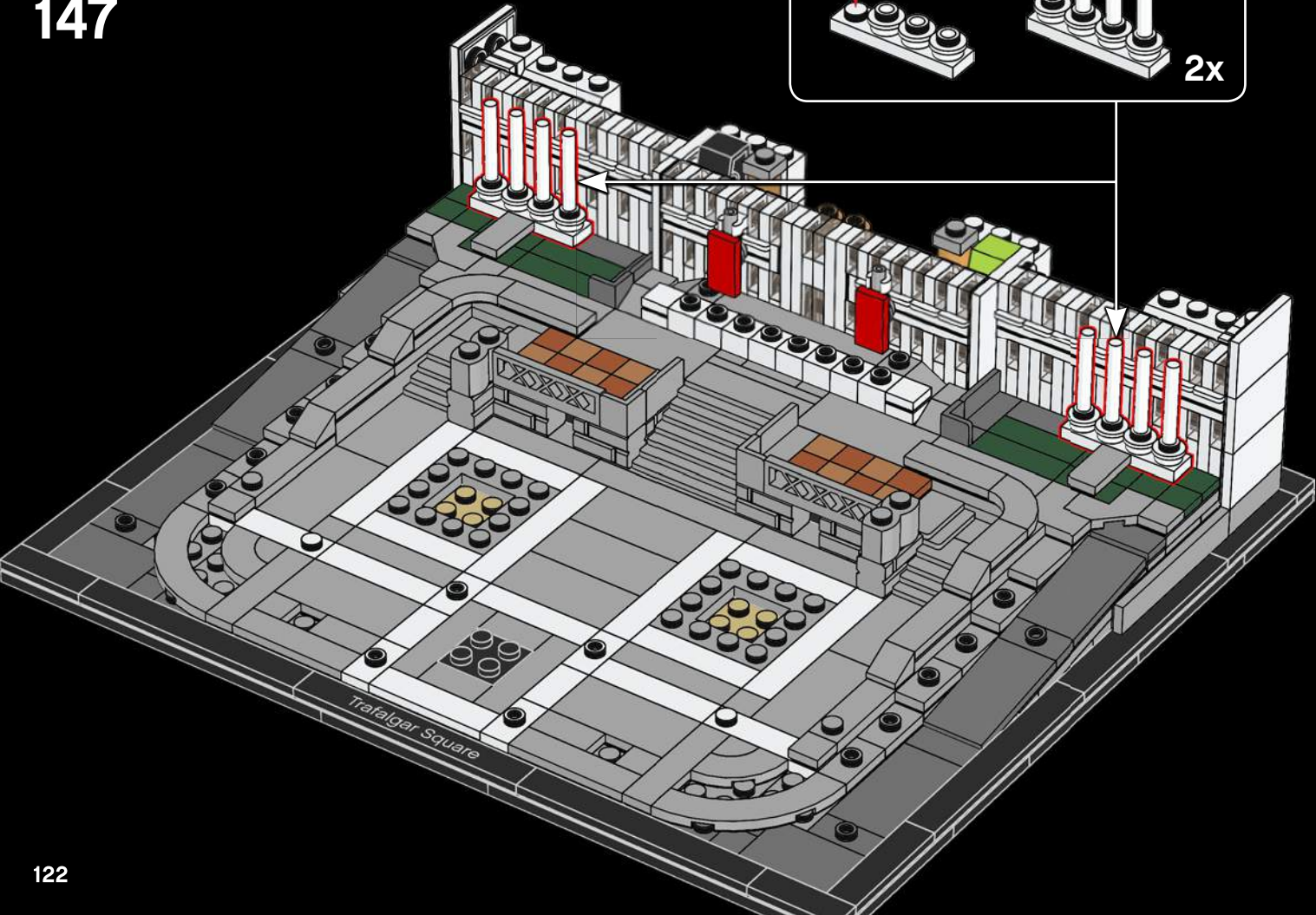
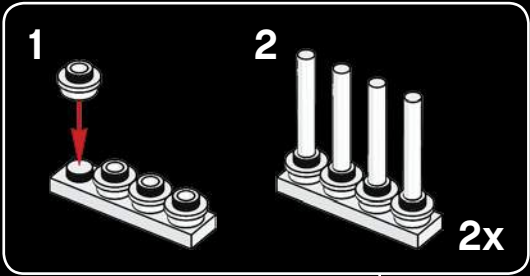

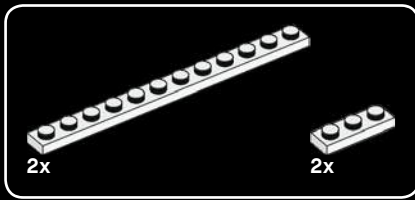

148

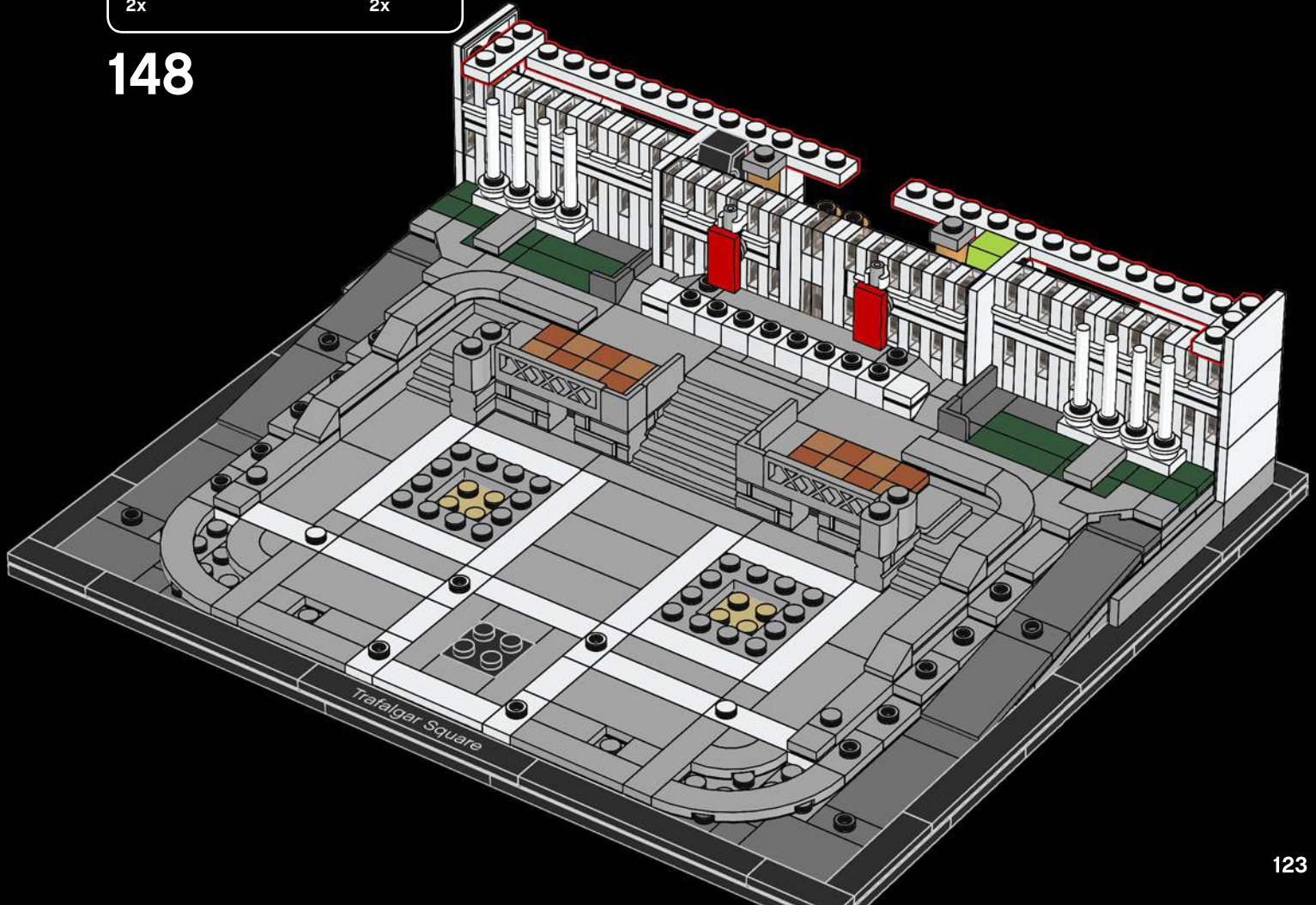

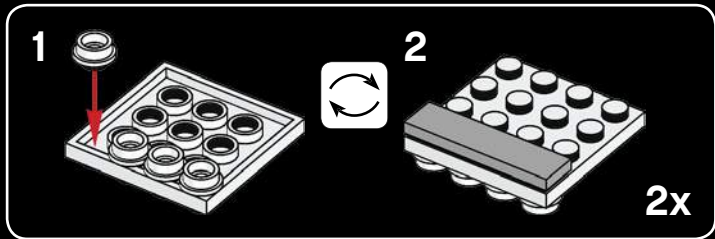
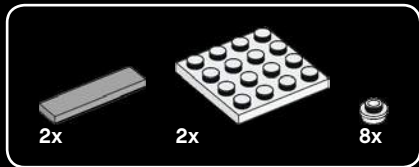

149

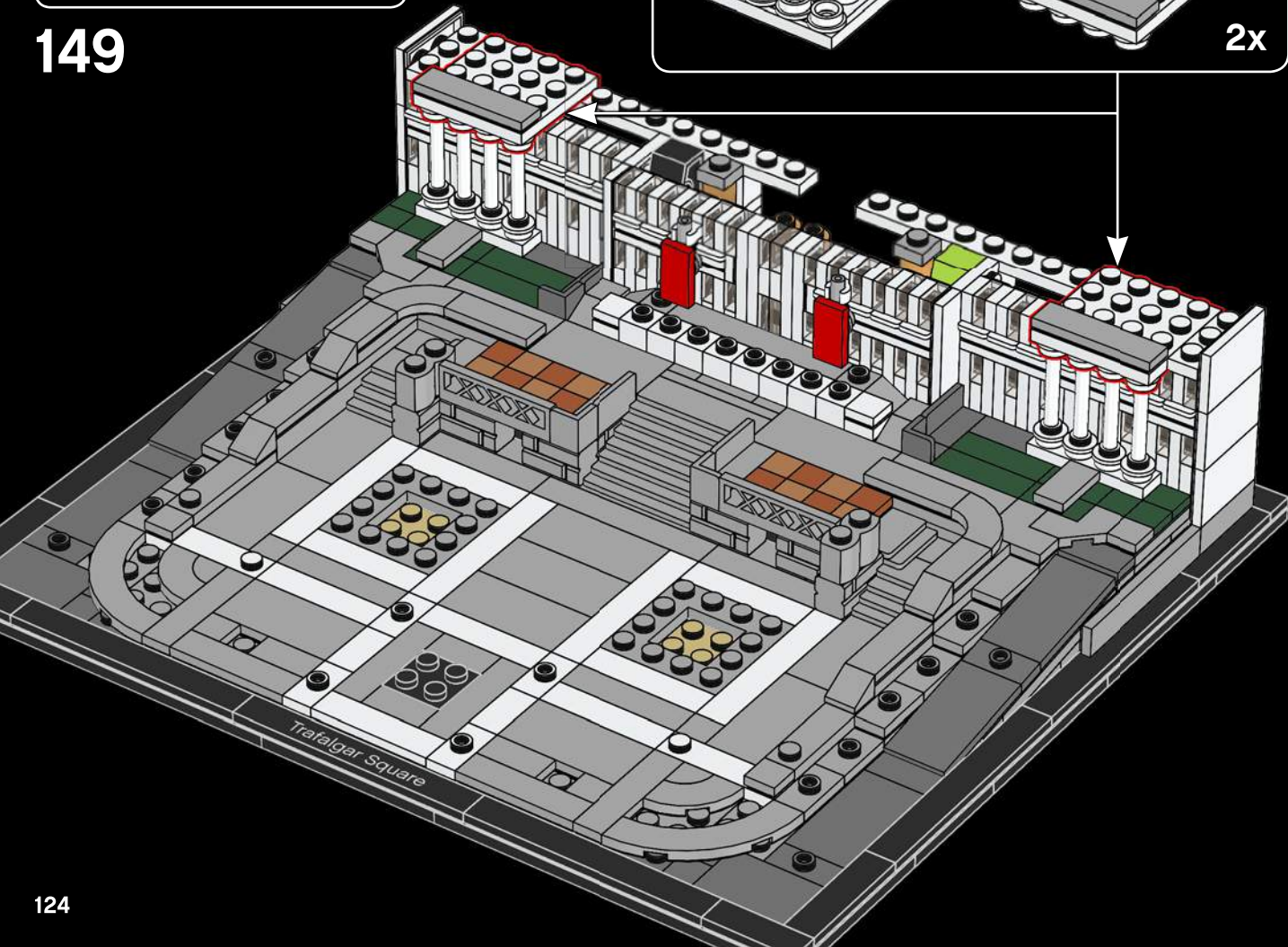

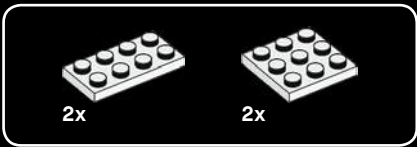

150

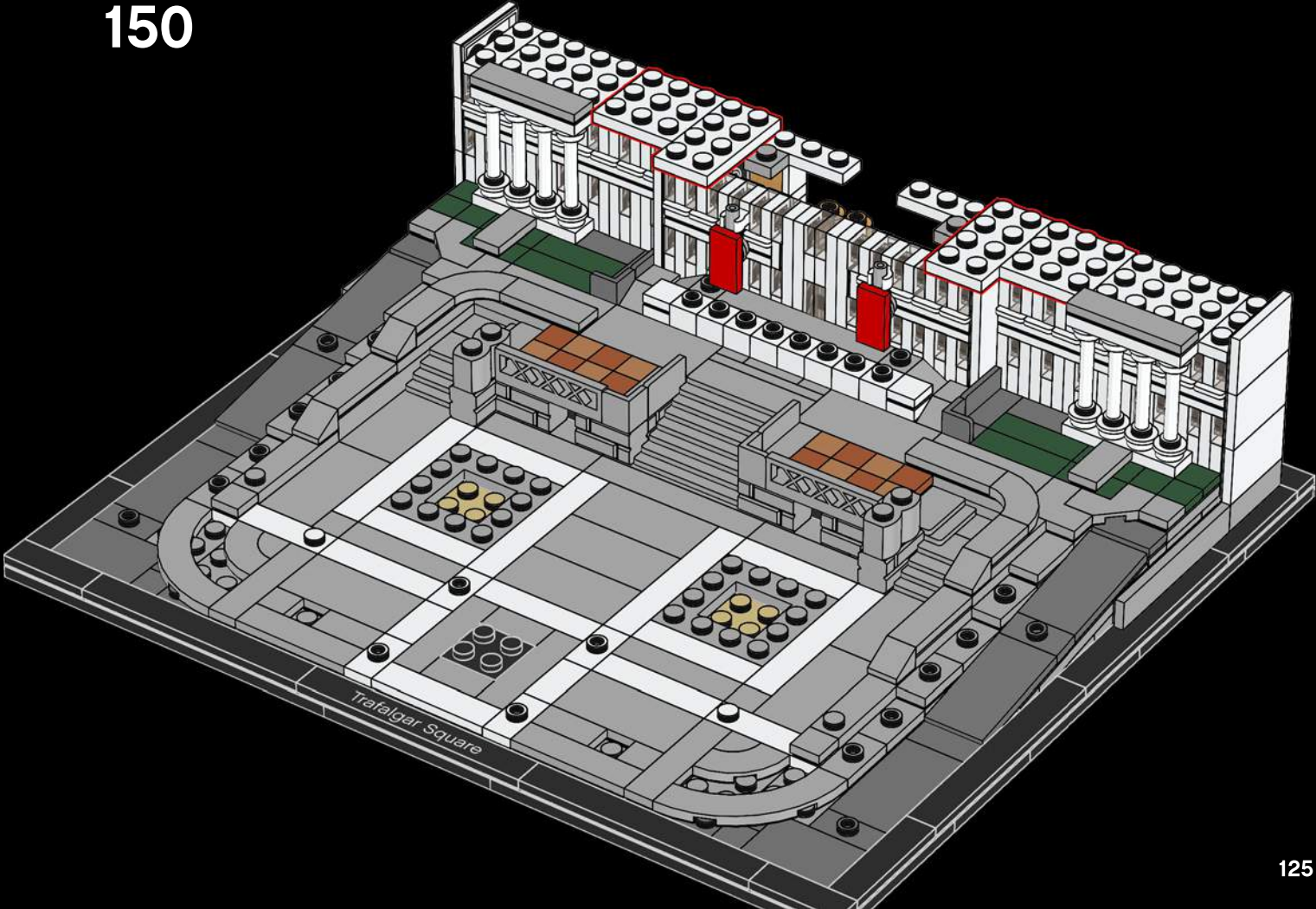



10x

151

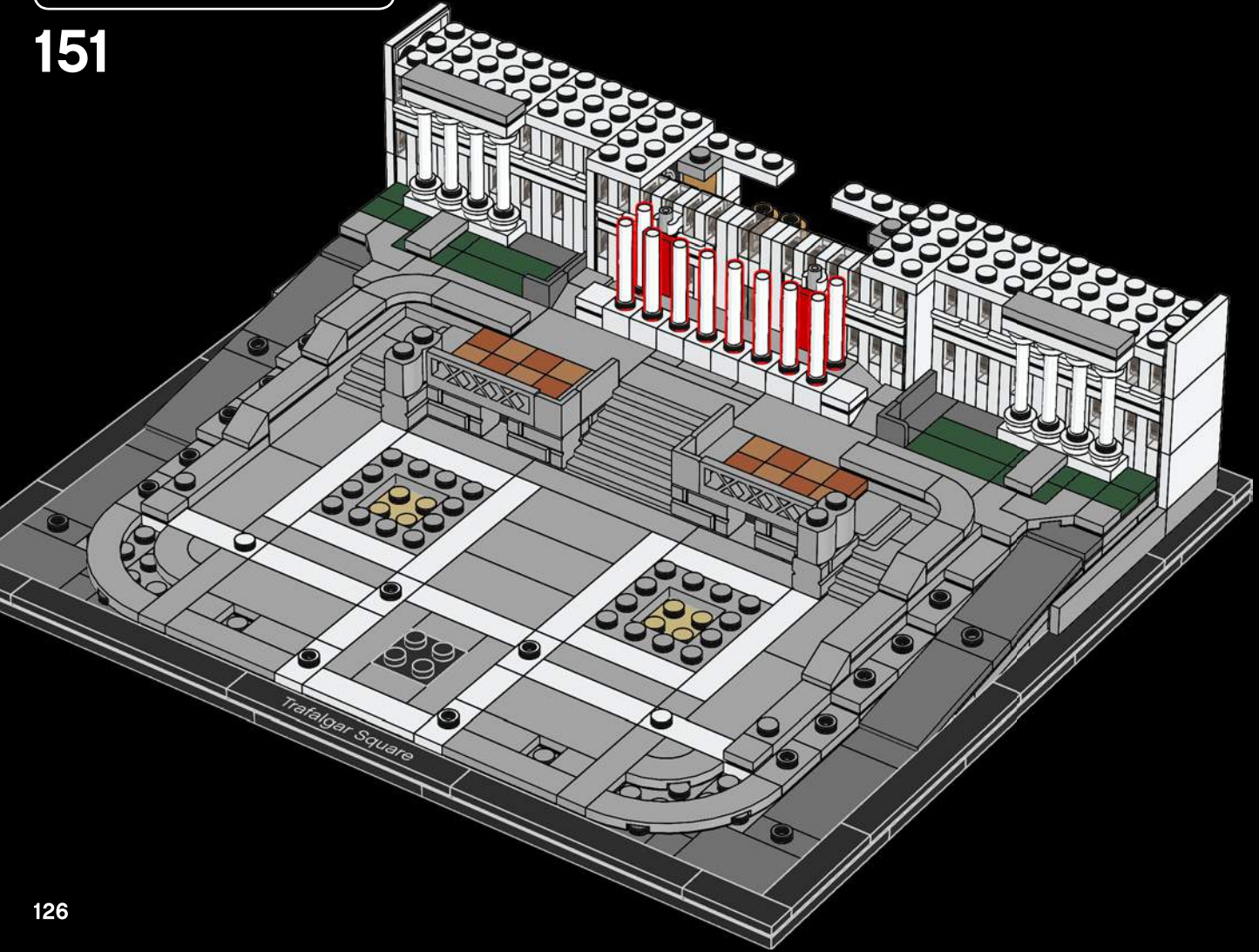

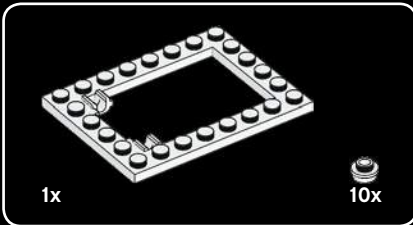
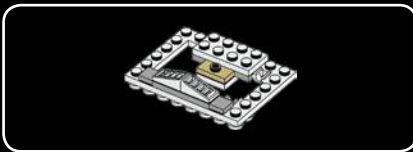

152

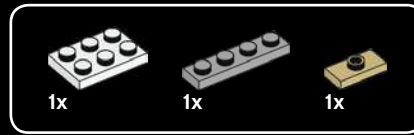
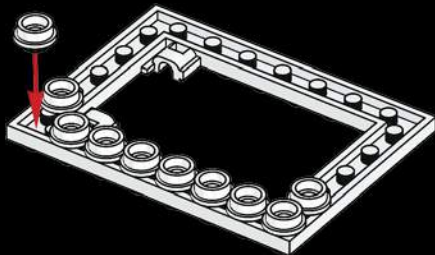

153

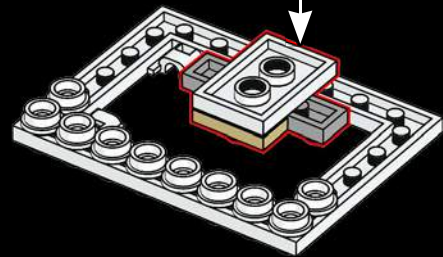
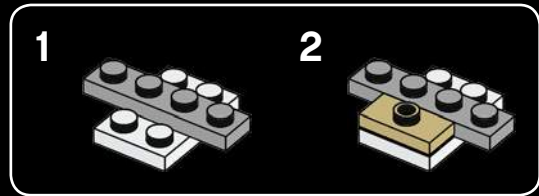

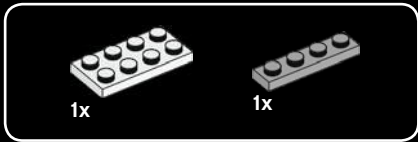

154

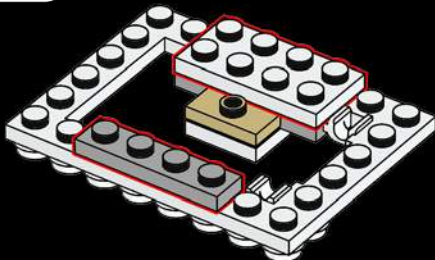

155

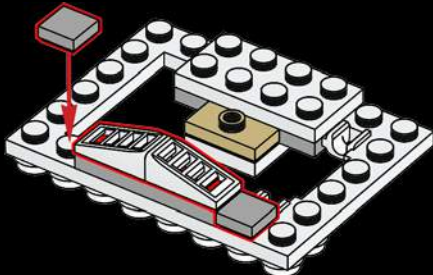



156

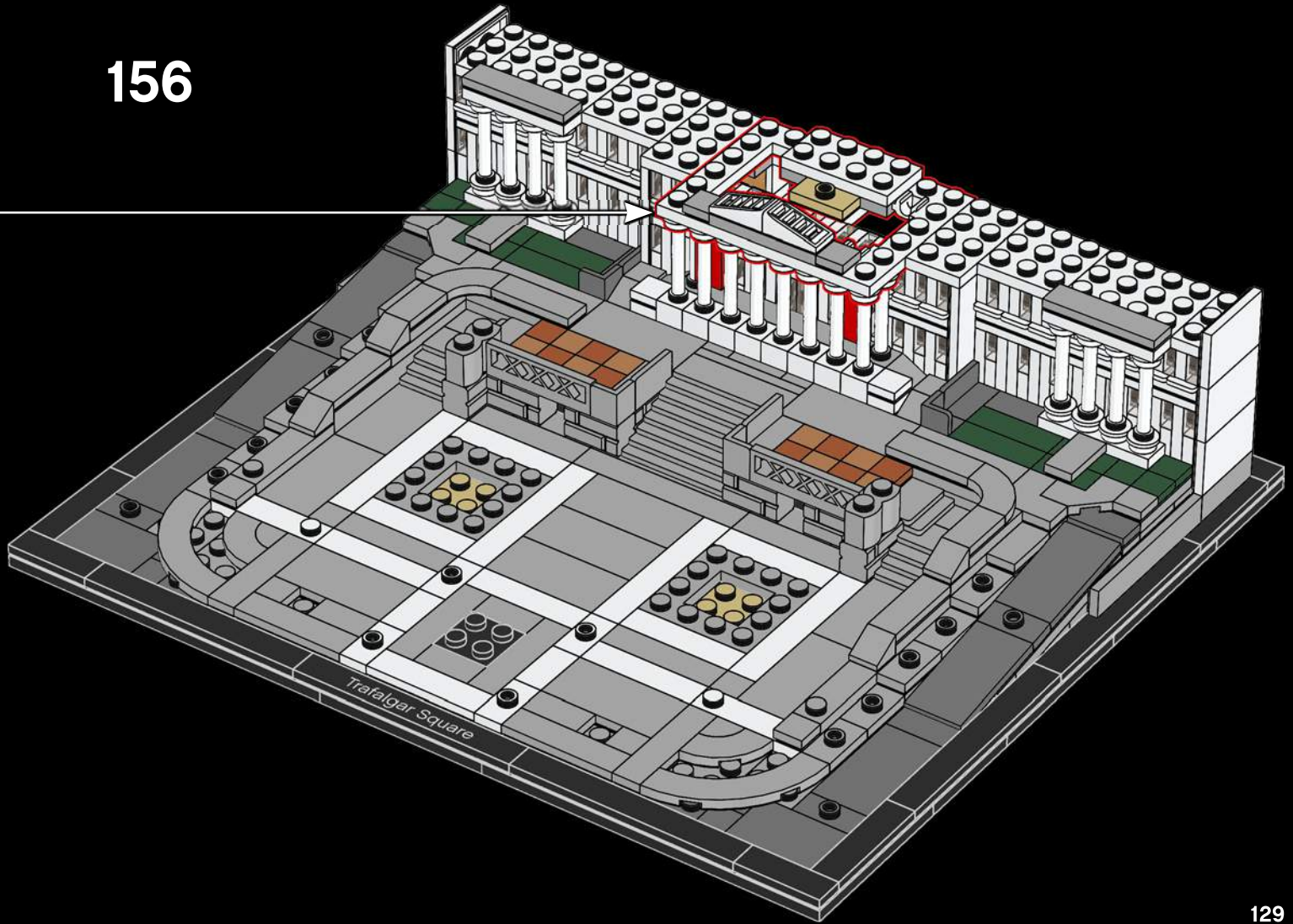

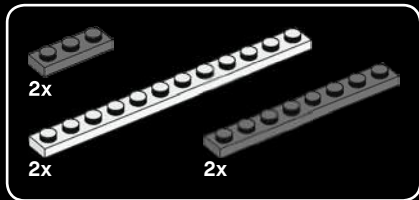

157

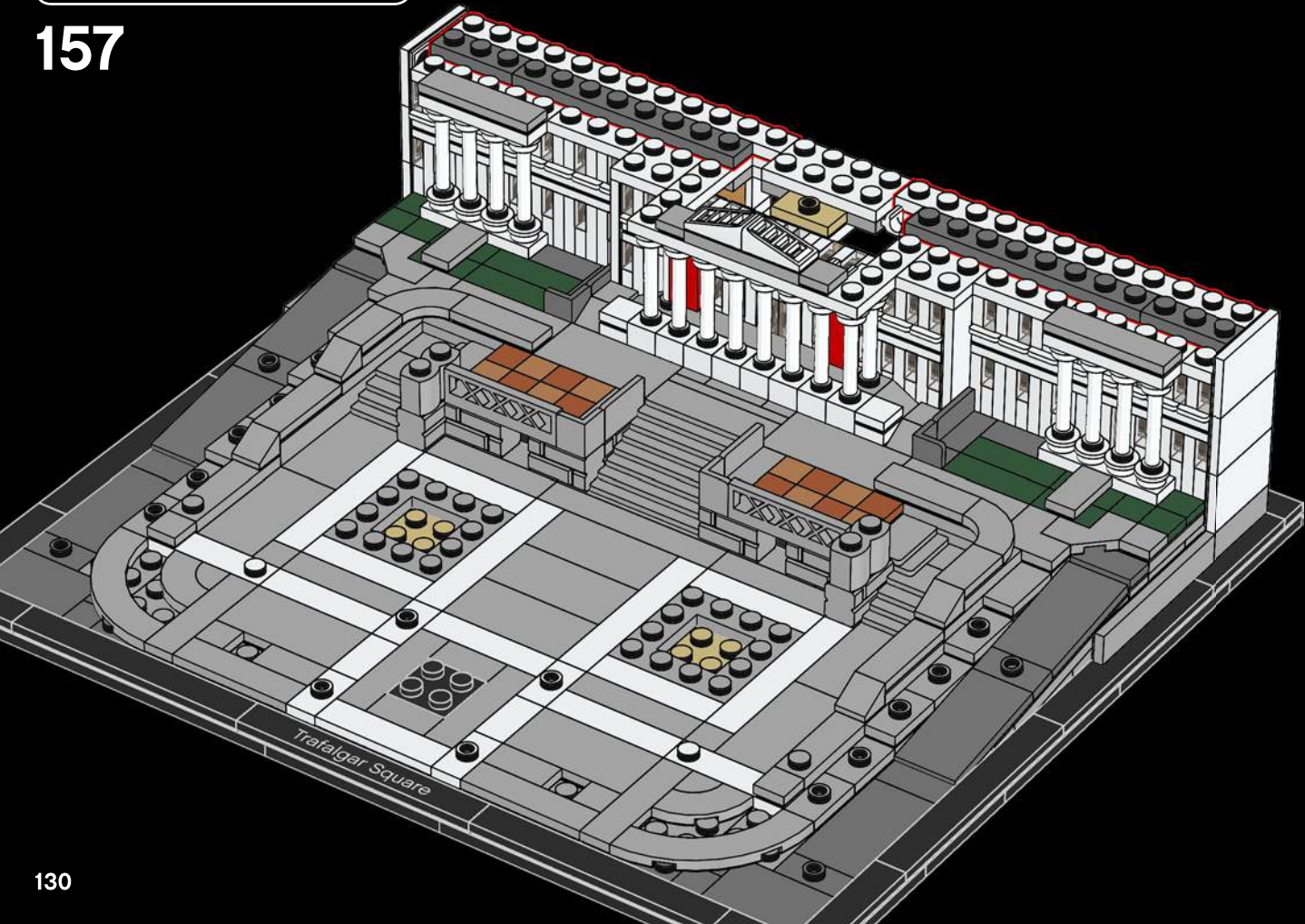

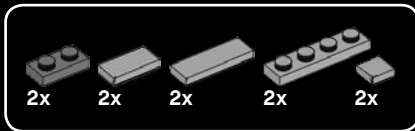

158

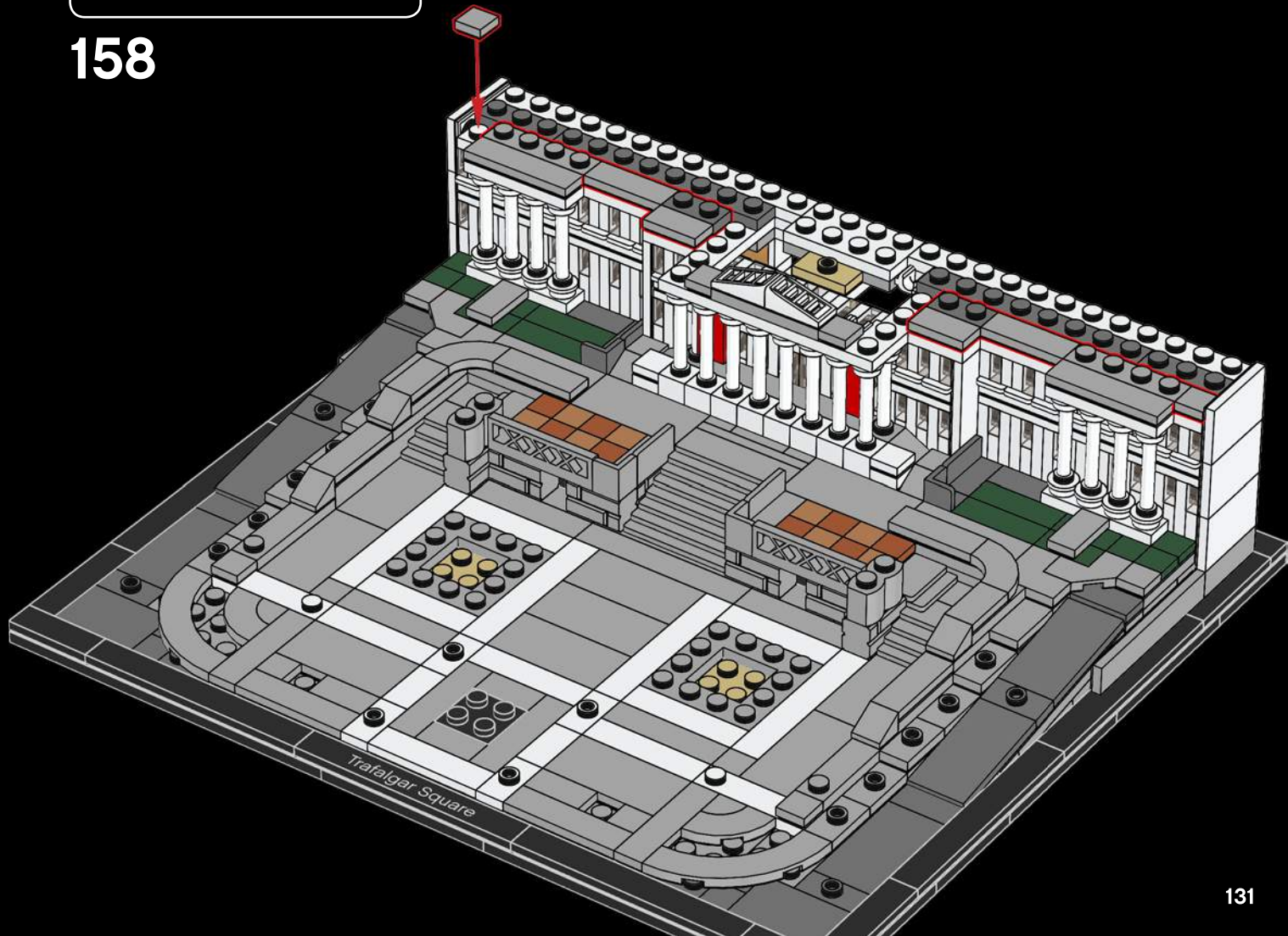



159

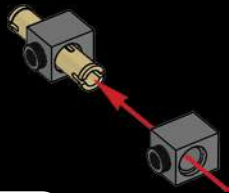

160

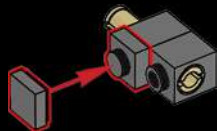

161

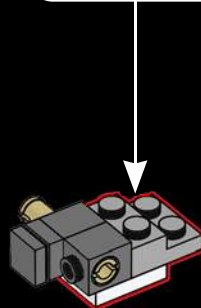
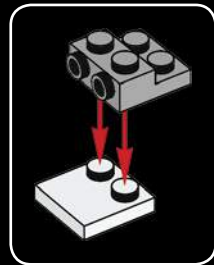



162

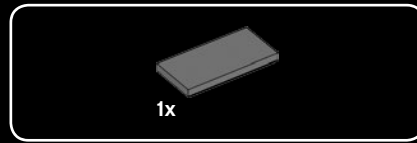
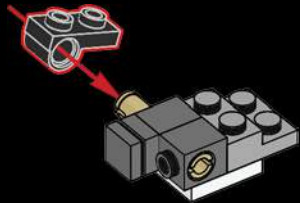

163



164

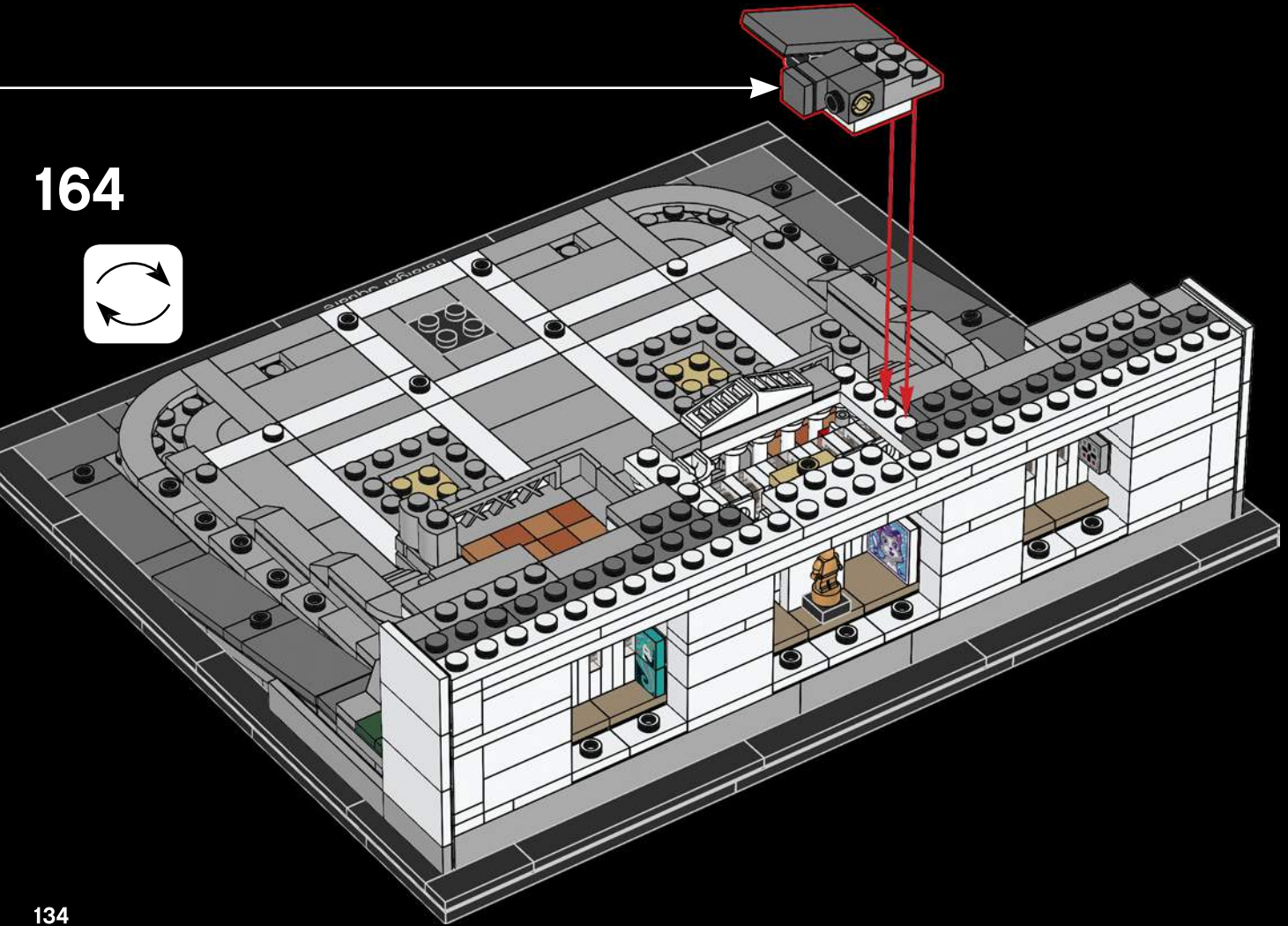



165

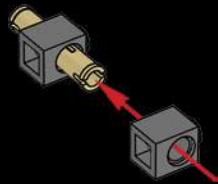

166

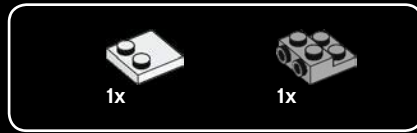
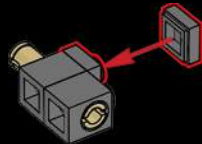

167

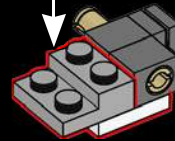
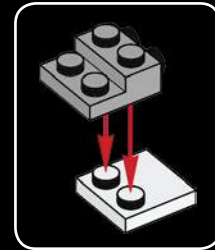



1x

168

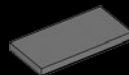
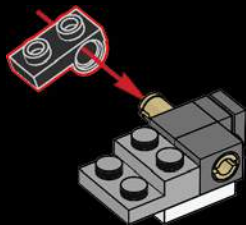

1x

169

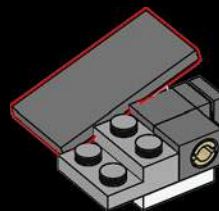



170

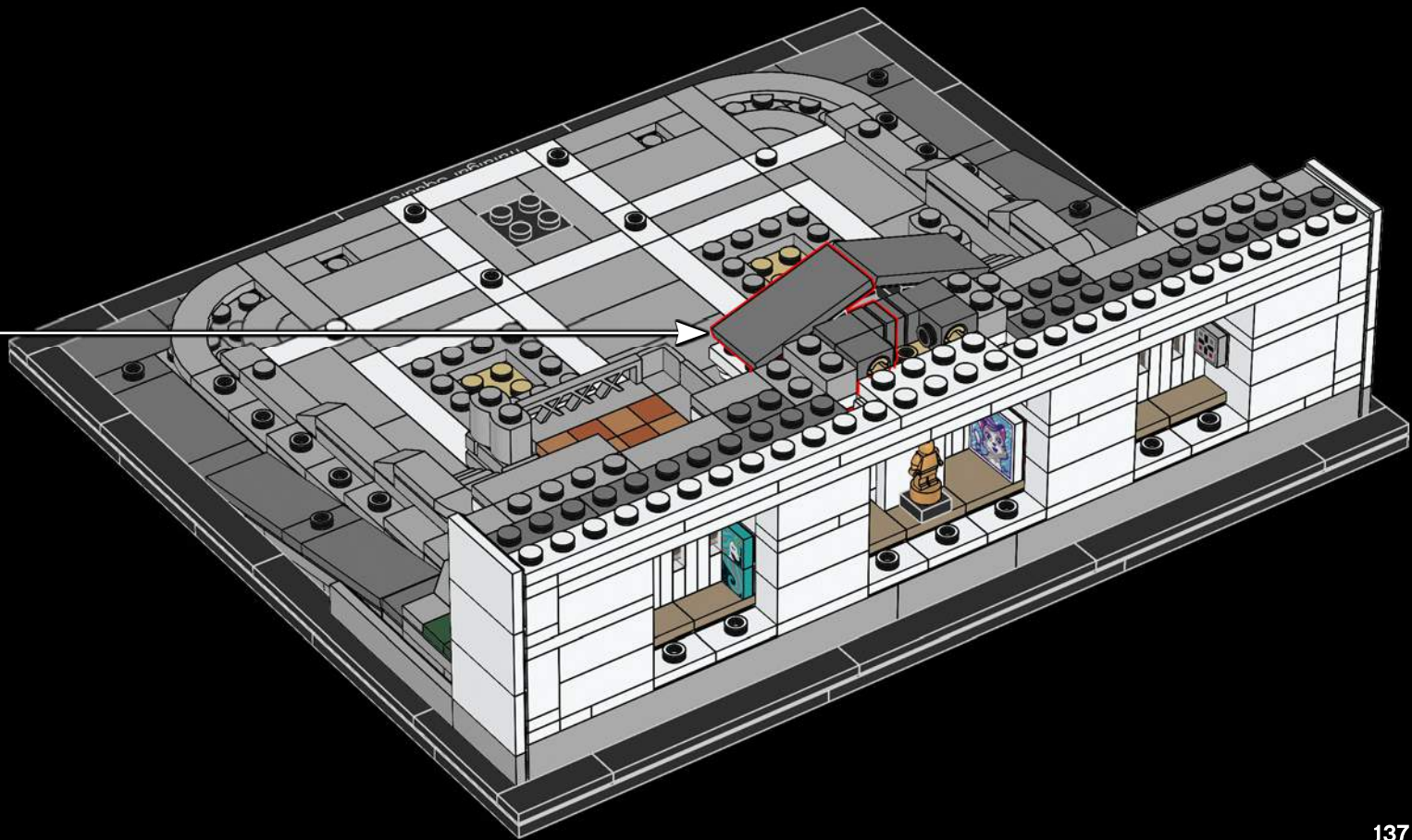



2x

171

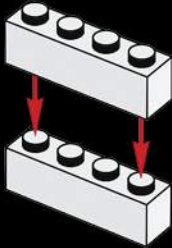

1x



1x

172

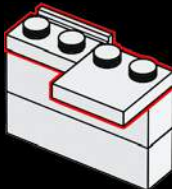

1x

173

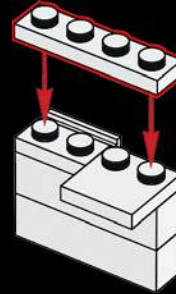

2x

174

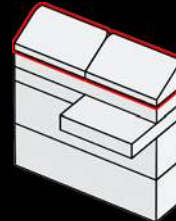

175

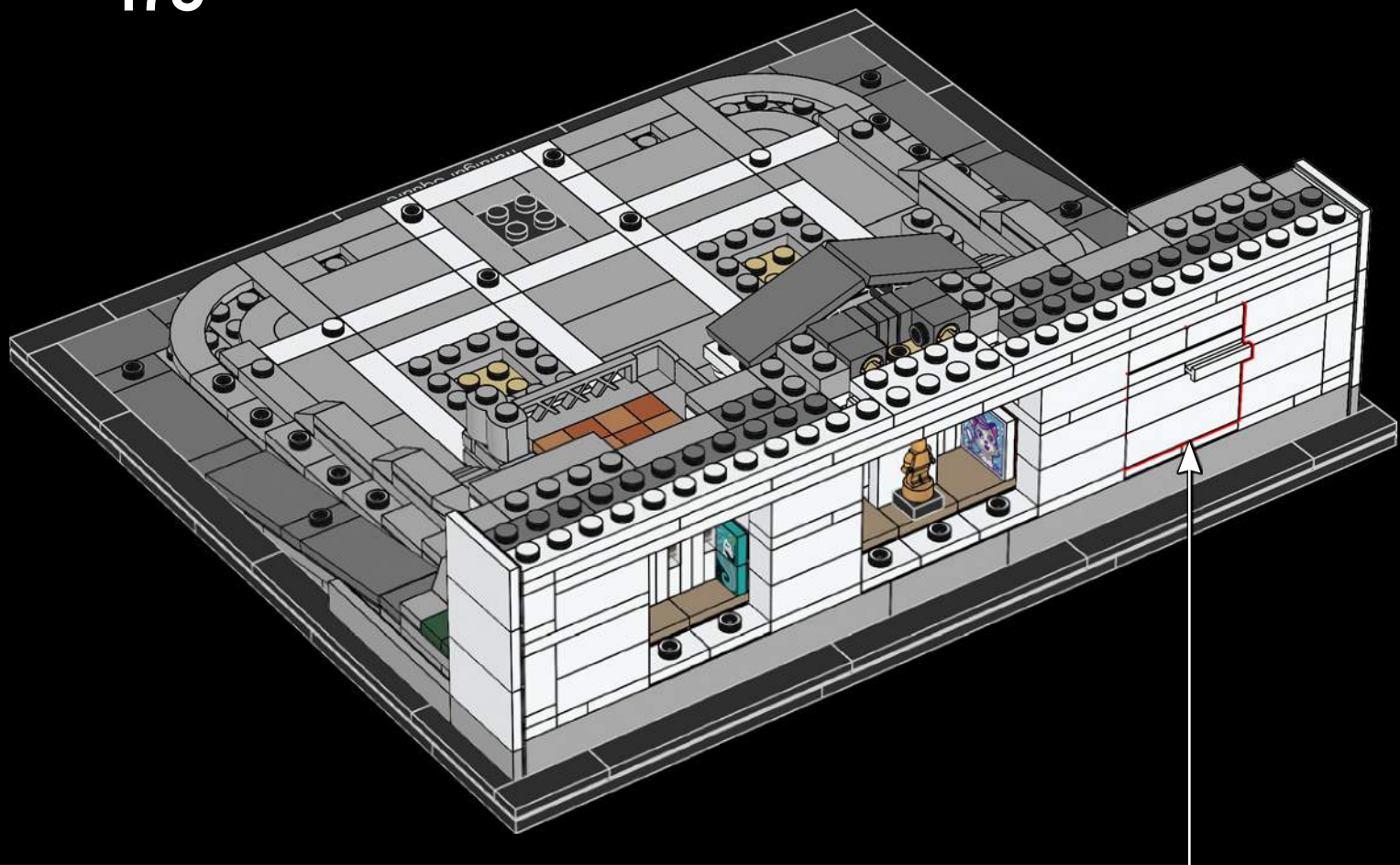

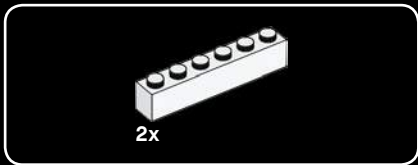

176

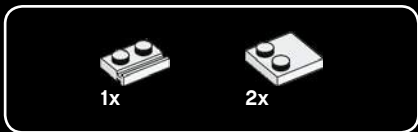
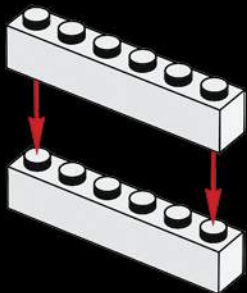

177

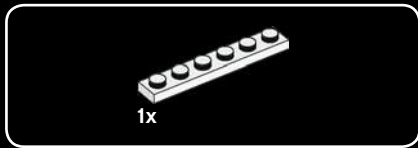
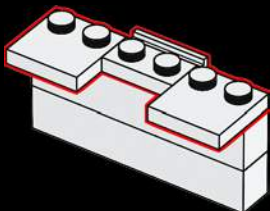

178

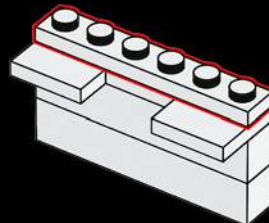

179

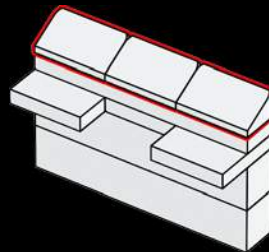

180

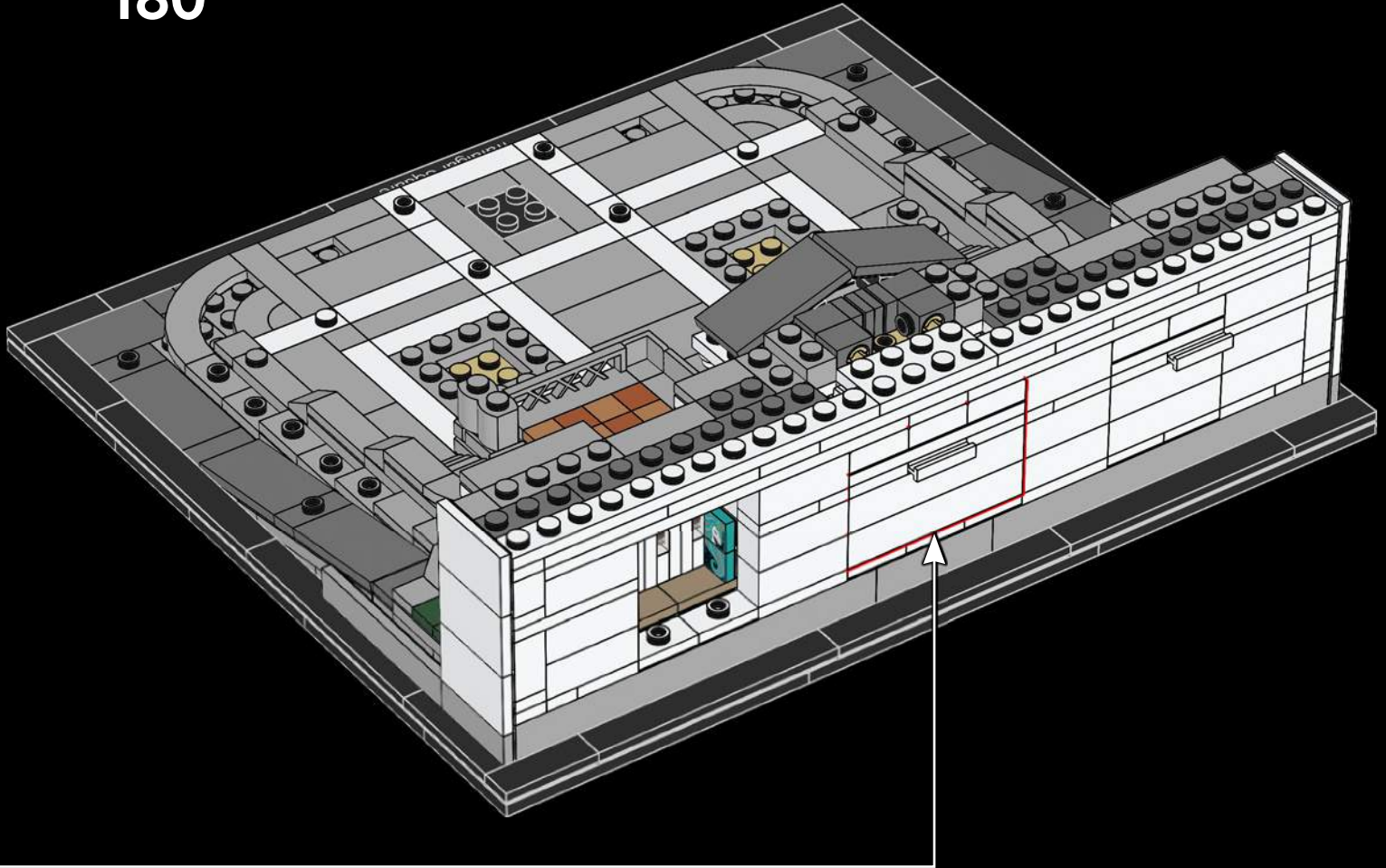



2x

# 181

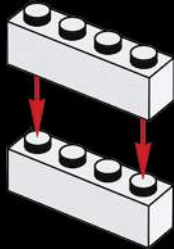

1x



1x

# 182

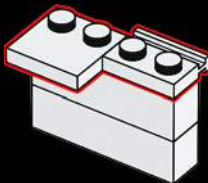

1x

# 183

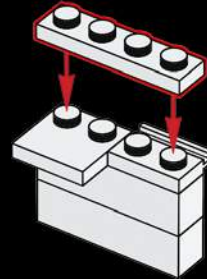

2x

# 184

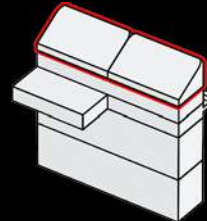

185

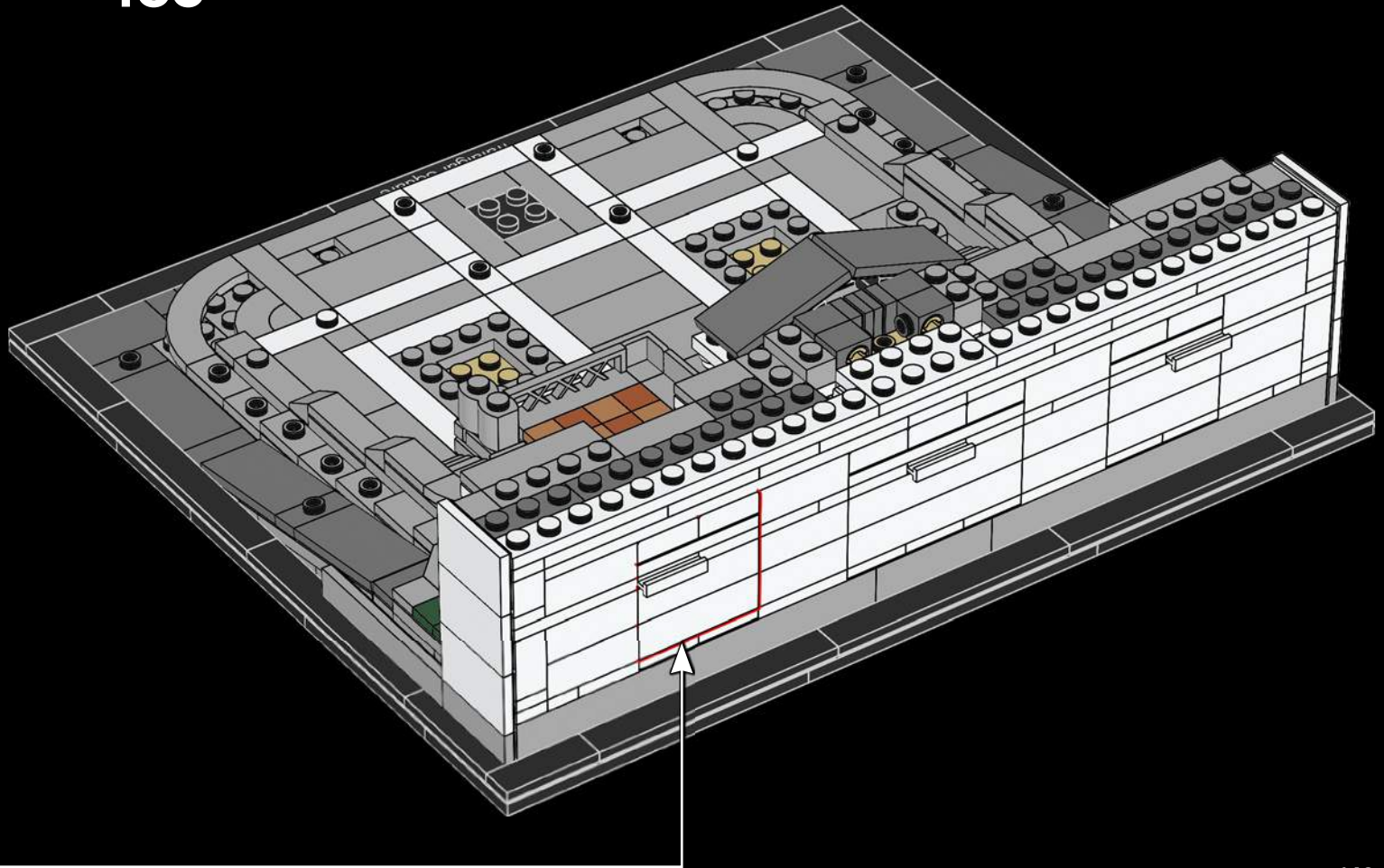

- 8x
- 2x
- 10x
- 6x

186

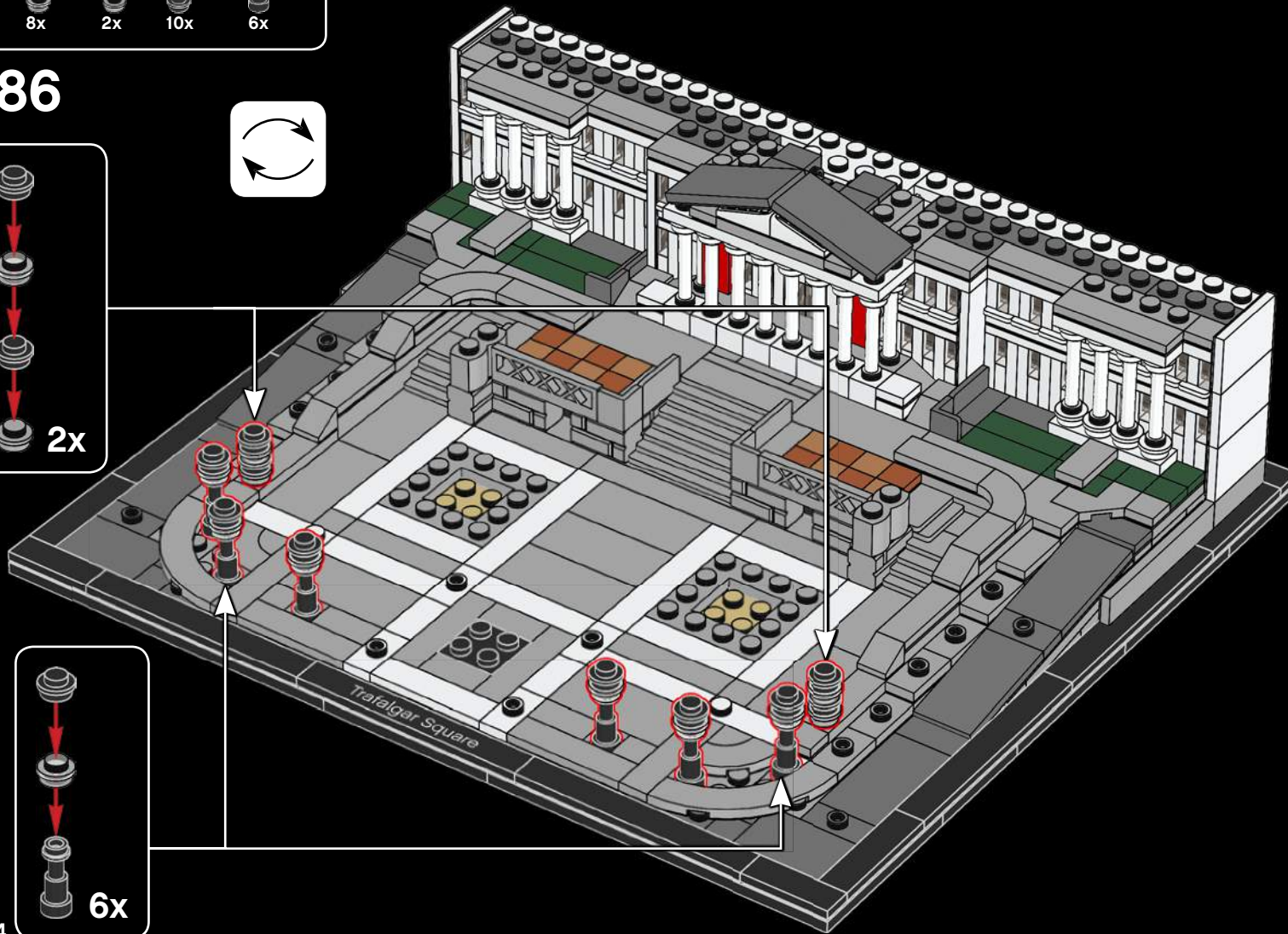
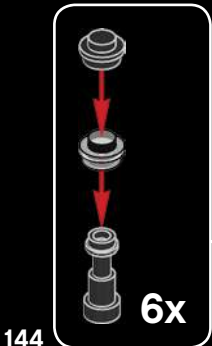
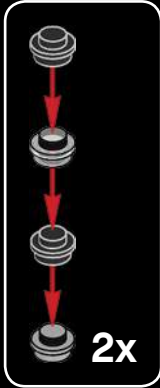







187

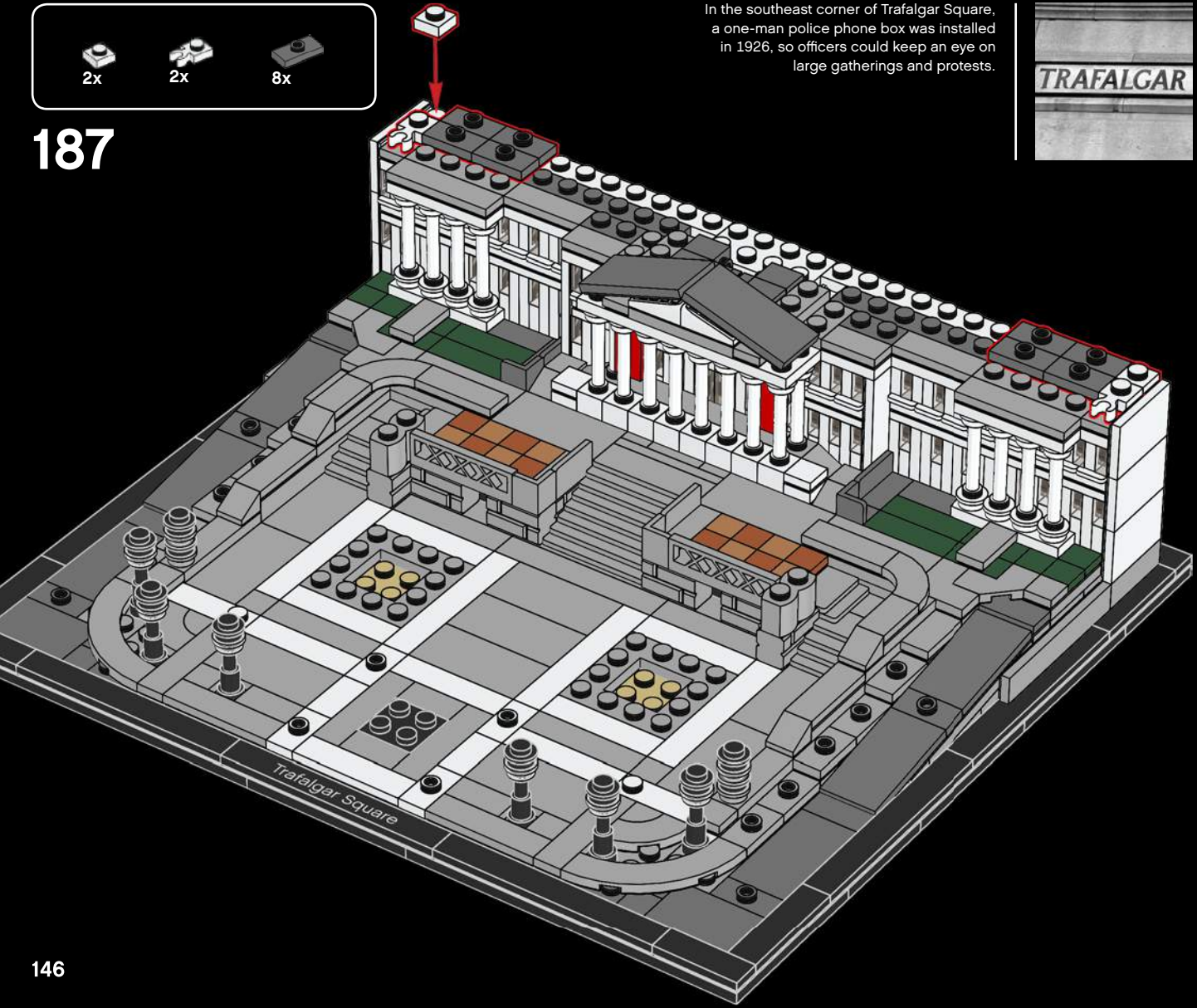

In the southeast corner of Trafalgar Square, a one-man police phone box was installed in 1926, so officers could keep an eye on large gatherings and protests.



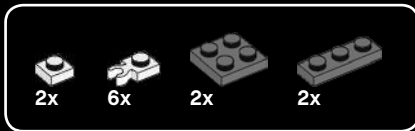

188

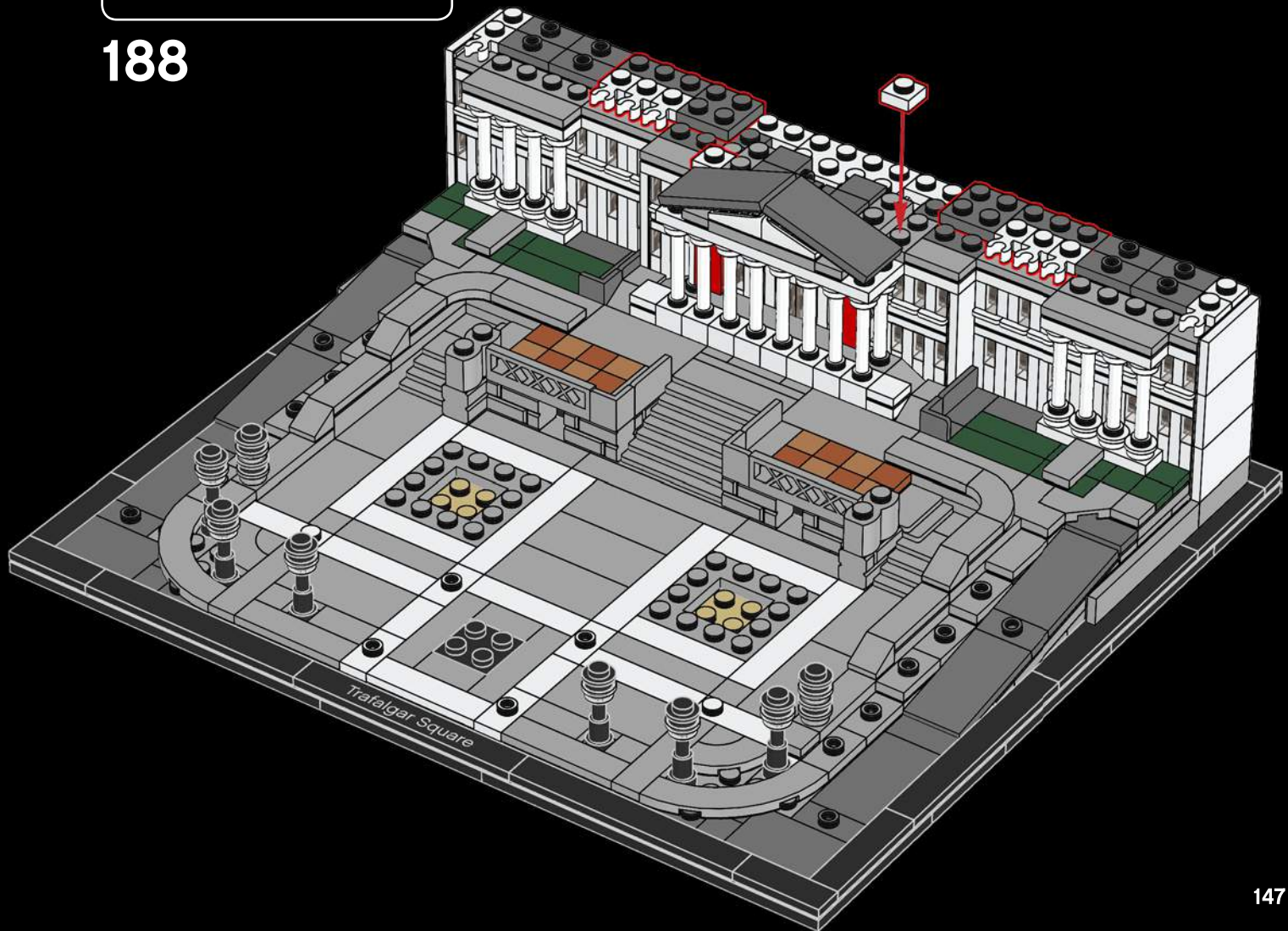

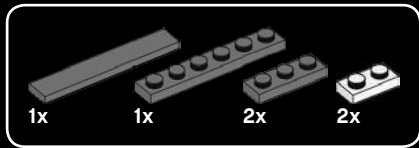

189

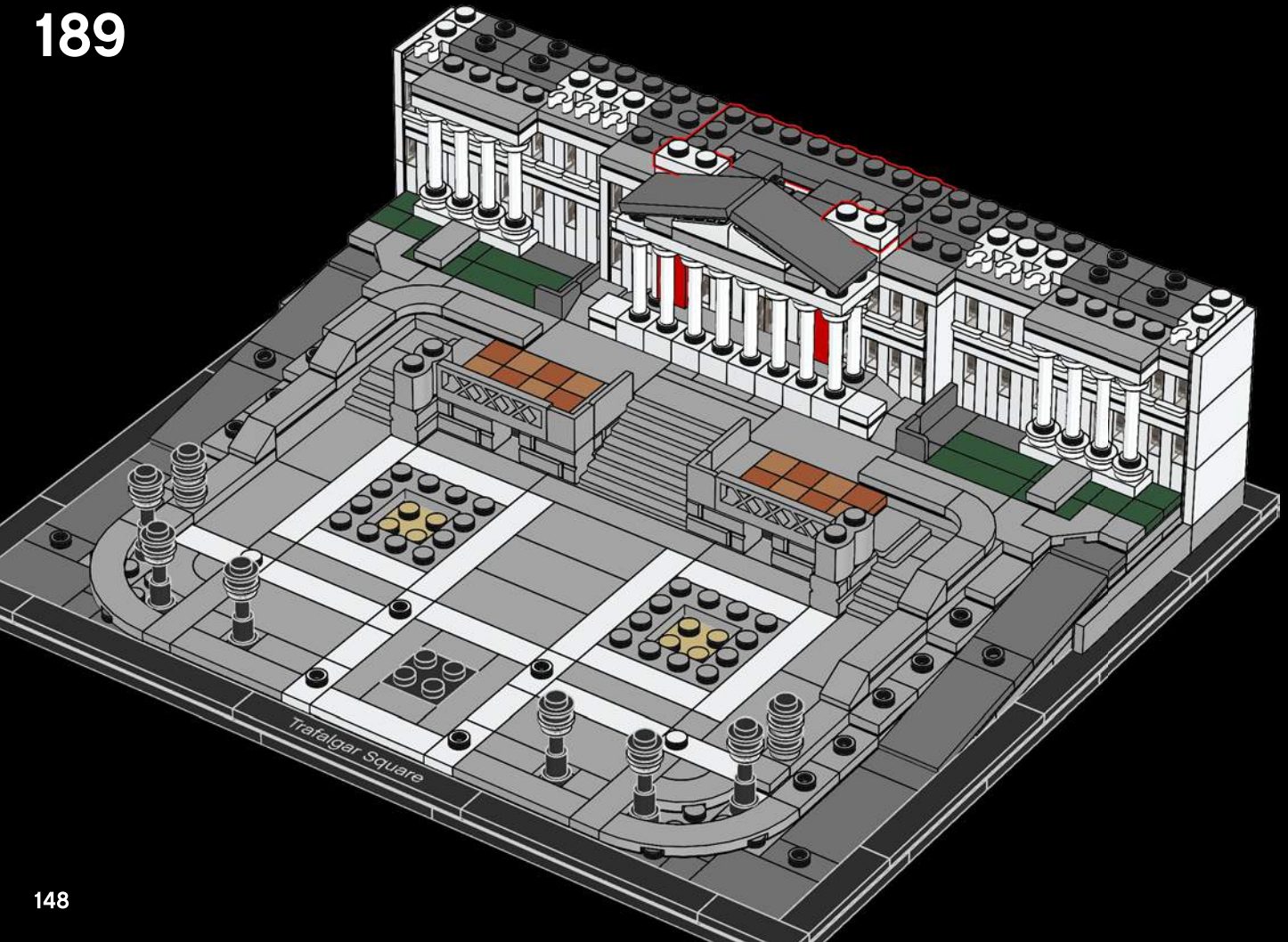



190

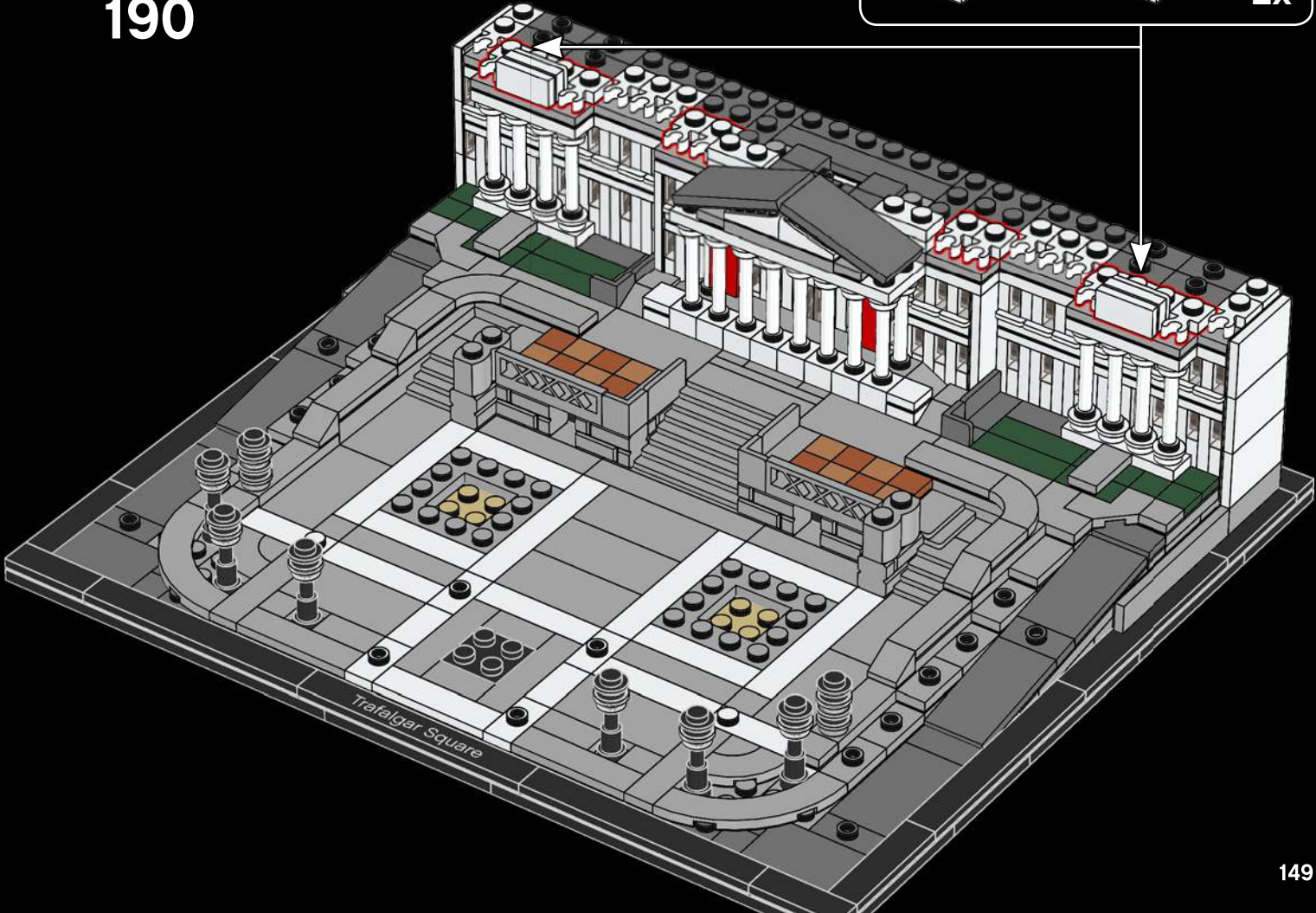
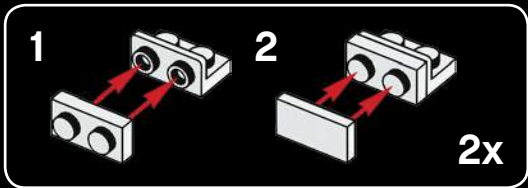

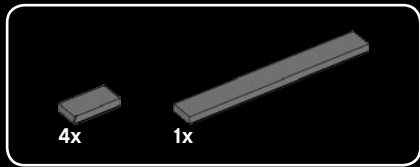

191

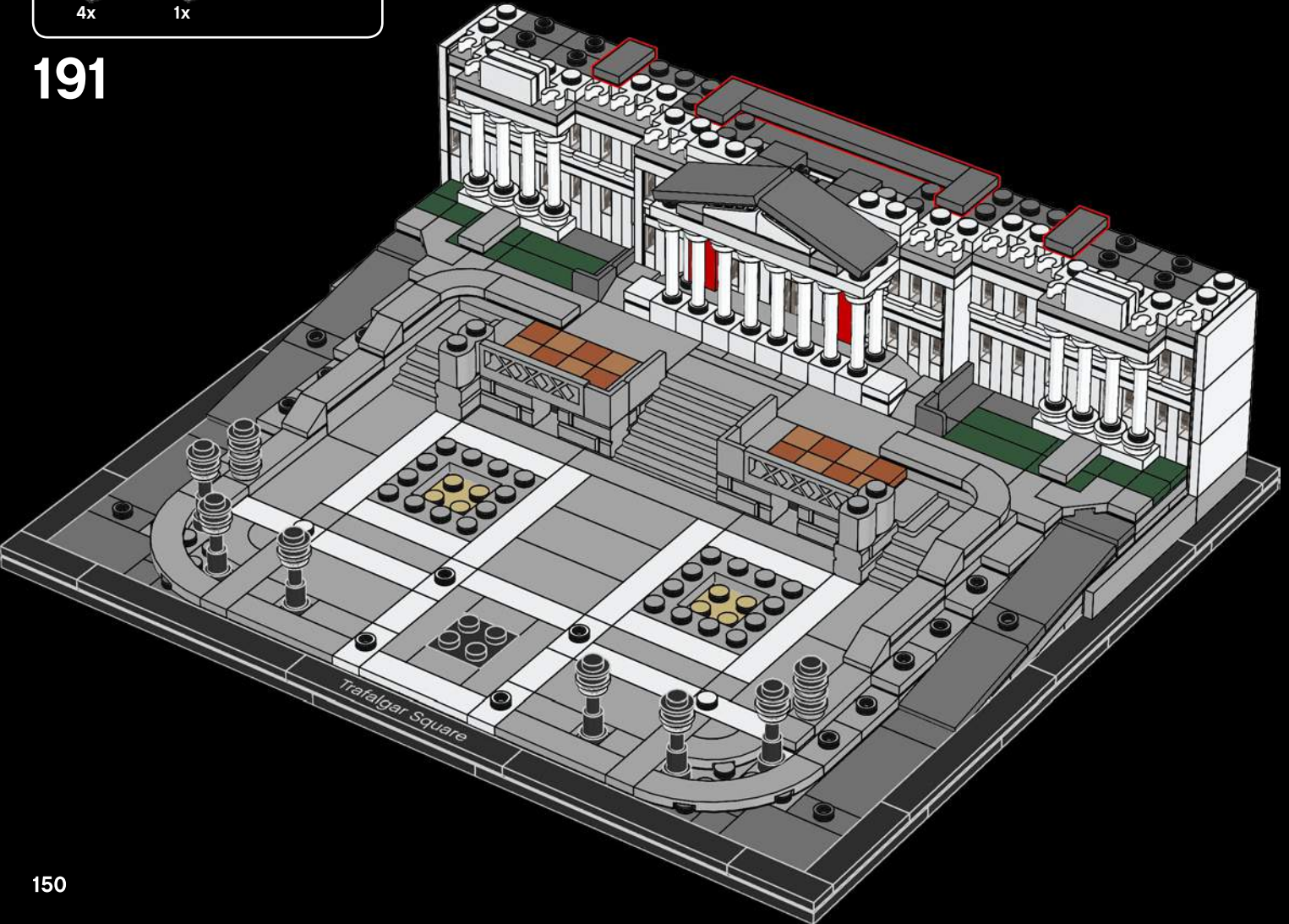

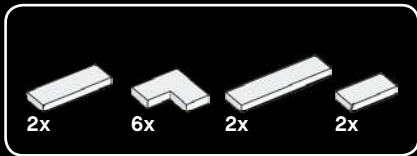

192





193

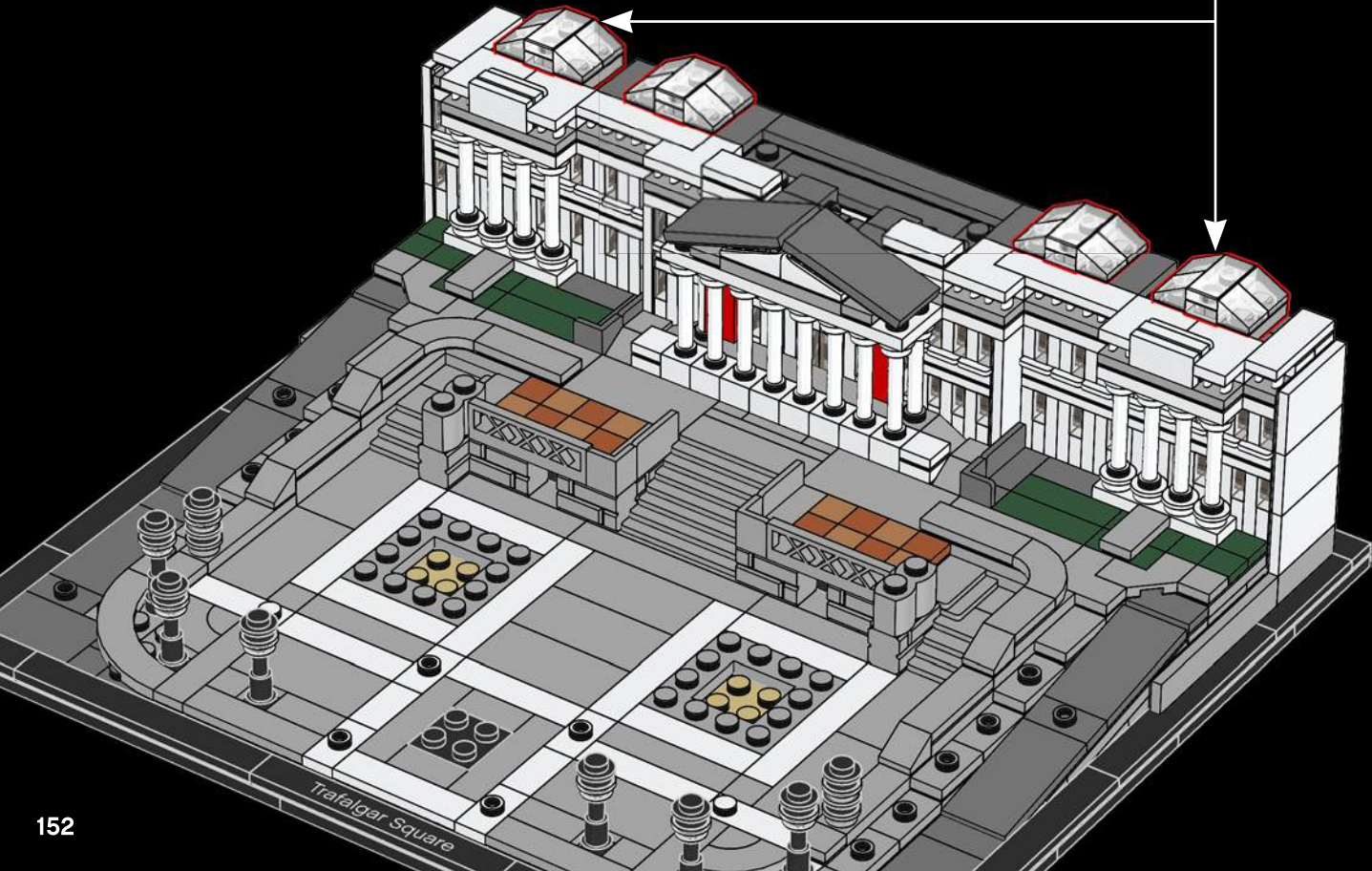
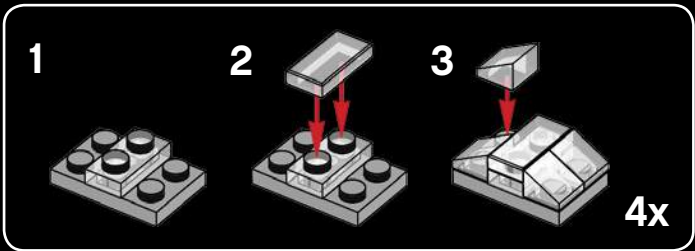





194

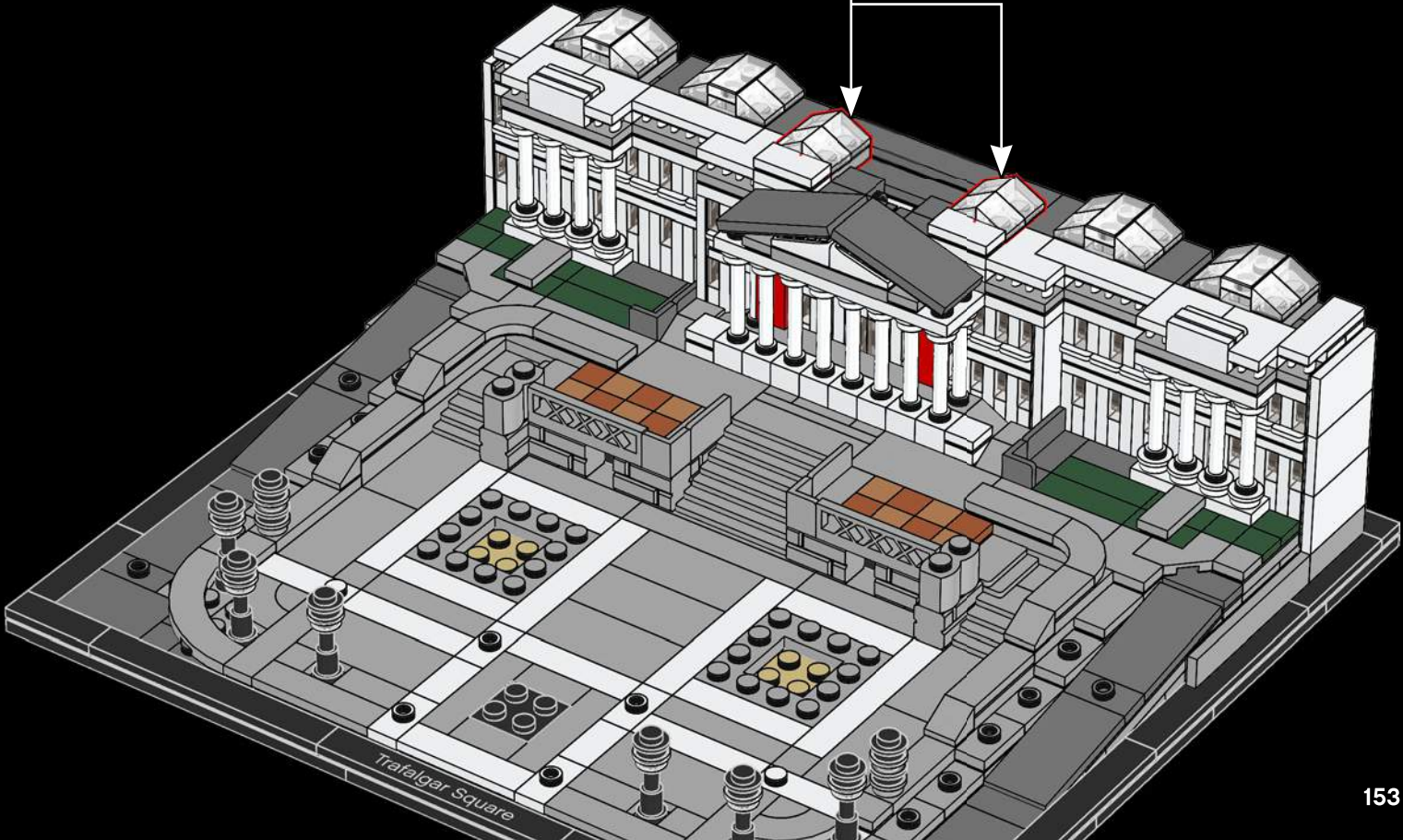
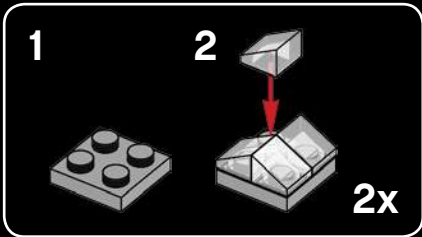

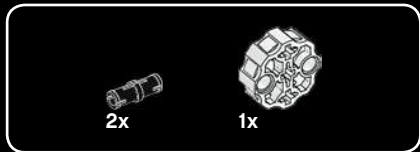

195



196

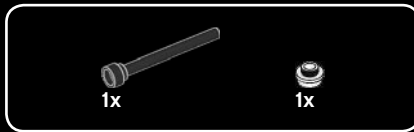

197



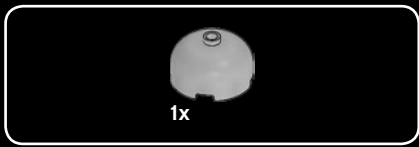

198

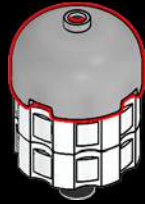

199

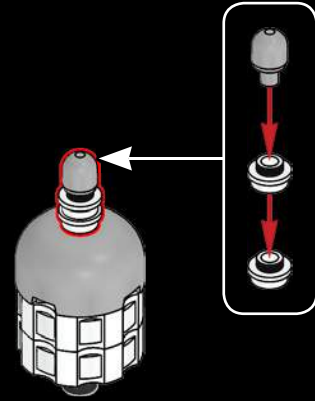

200

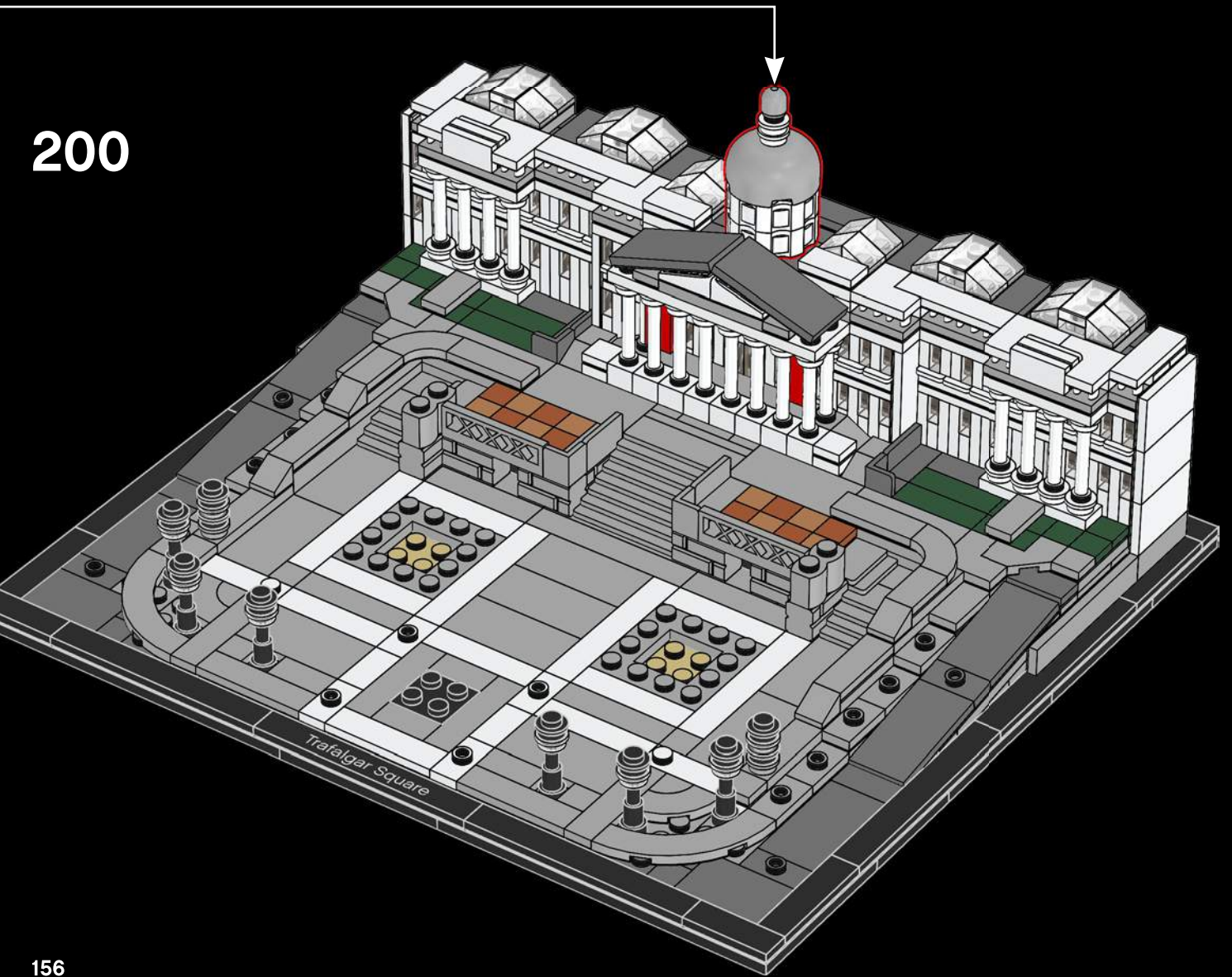

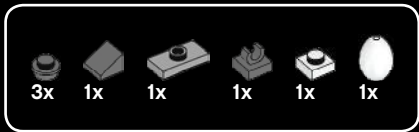

201

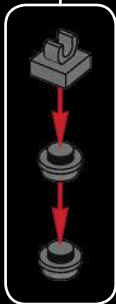
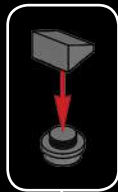



4x

202

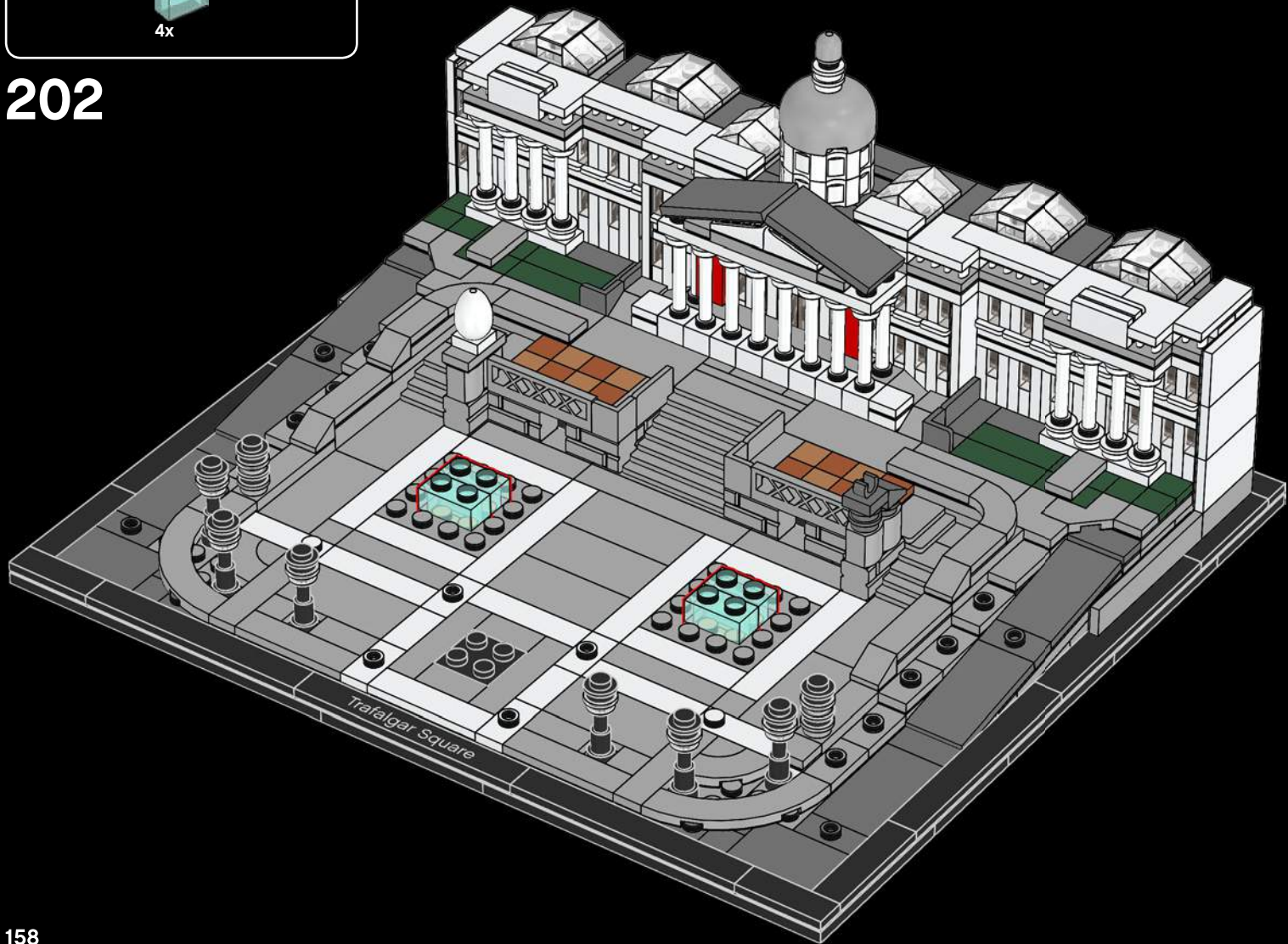



4x



4x



4x

# 203

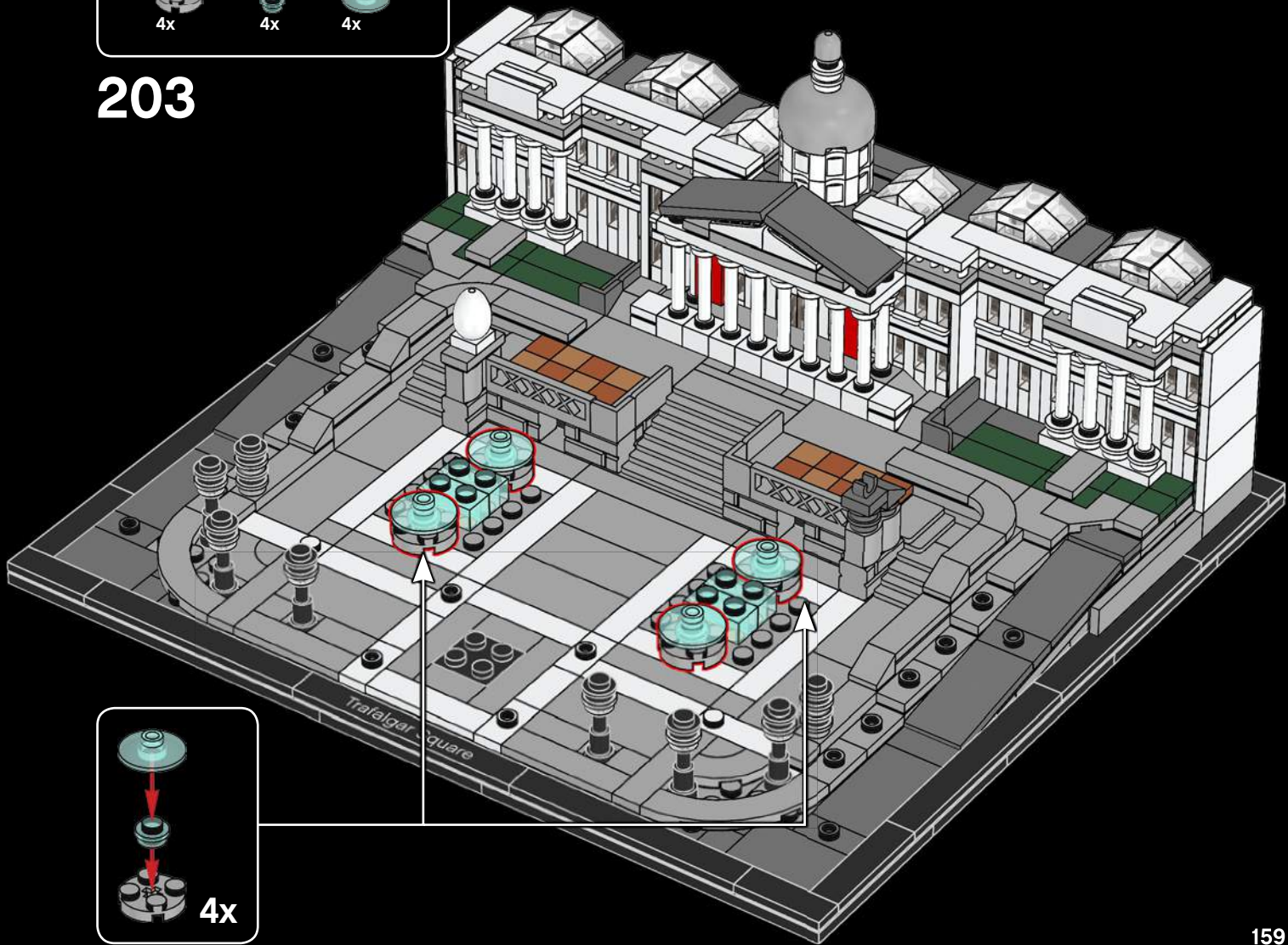

4x



8x



8x

204

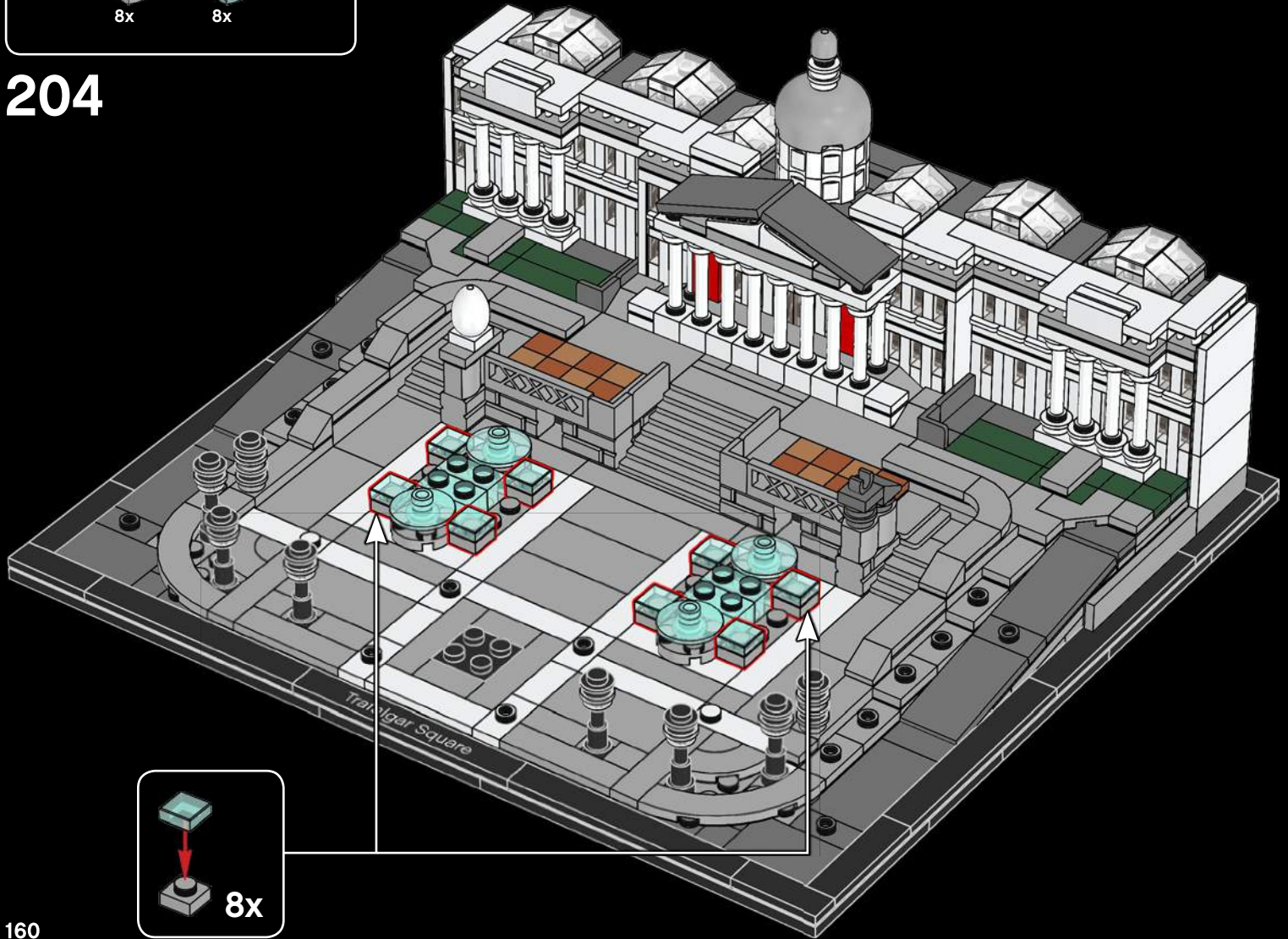

8x





2x

205

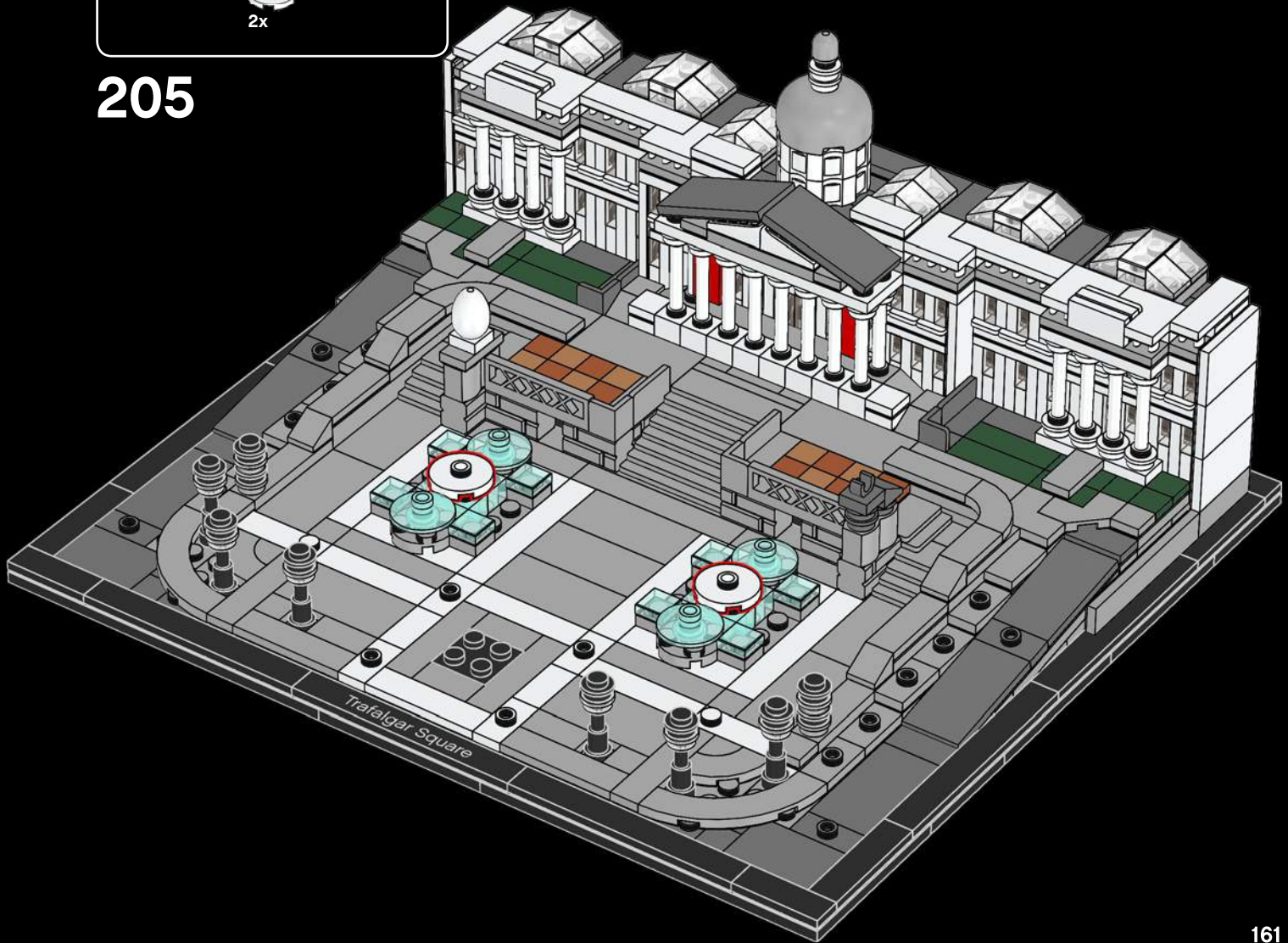



206

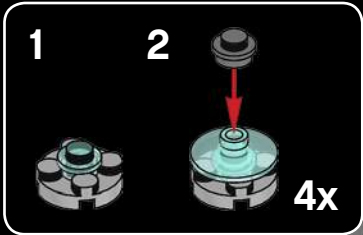



207

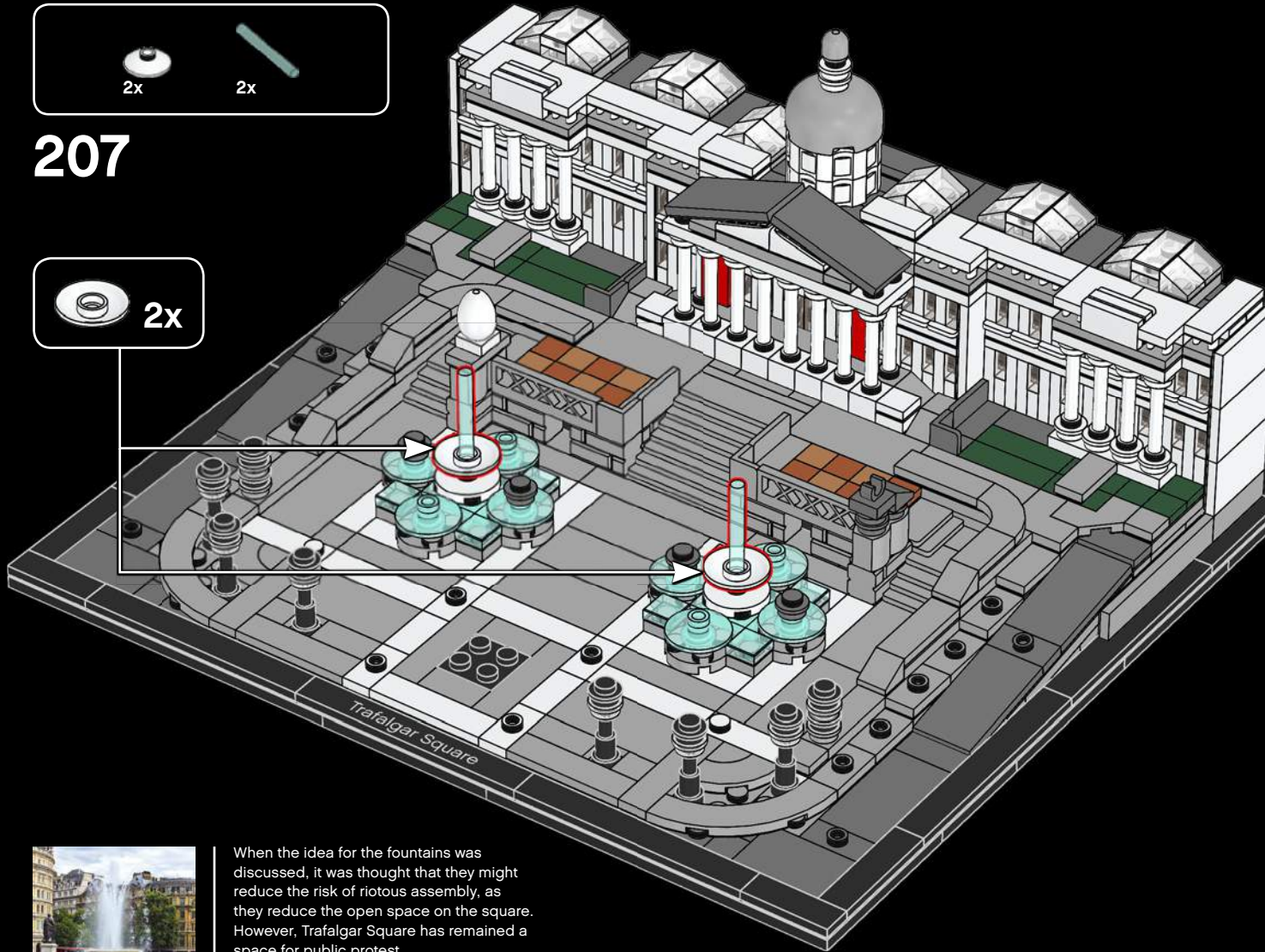

When the idea for the fountains was discussed, it was thought that they might reduce the risk of riotous assembly, as they reduce the open space on the square. However, Trafalgar Square has remained a space for public protest.



1x



2x

# 208

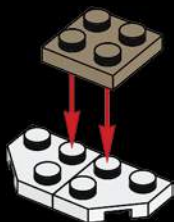

2x

# 209



4x

# 210



1x

# 211





212

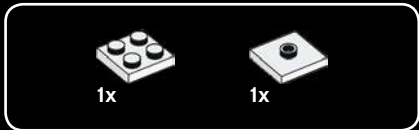
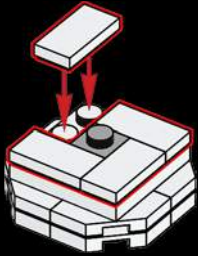

213

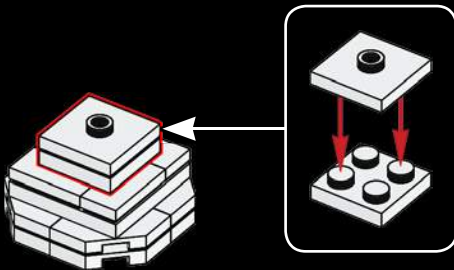

214

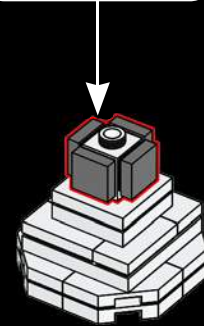
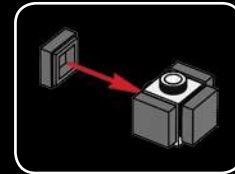



The four bronze reliefs around the base of Nelson's Column show Nelson's most famous battles: St. Vincent, Copenhagen, The Nile, and his death scene on The Victory at Trafalgar.

215

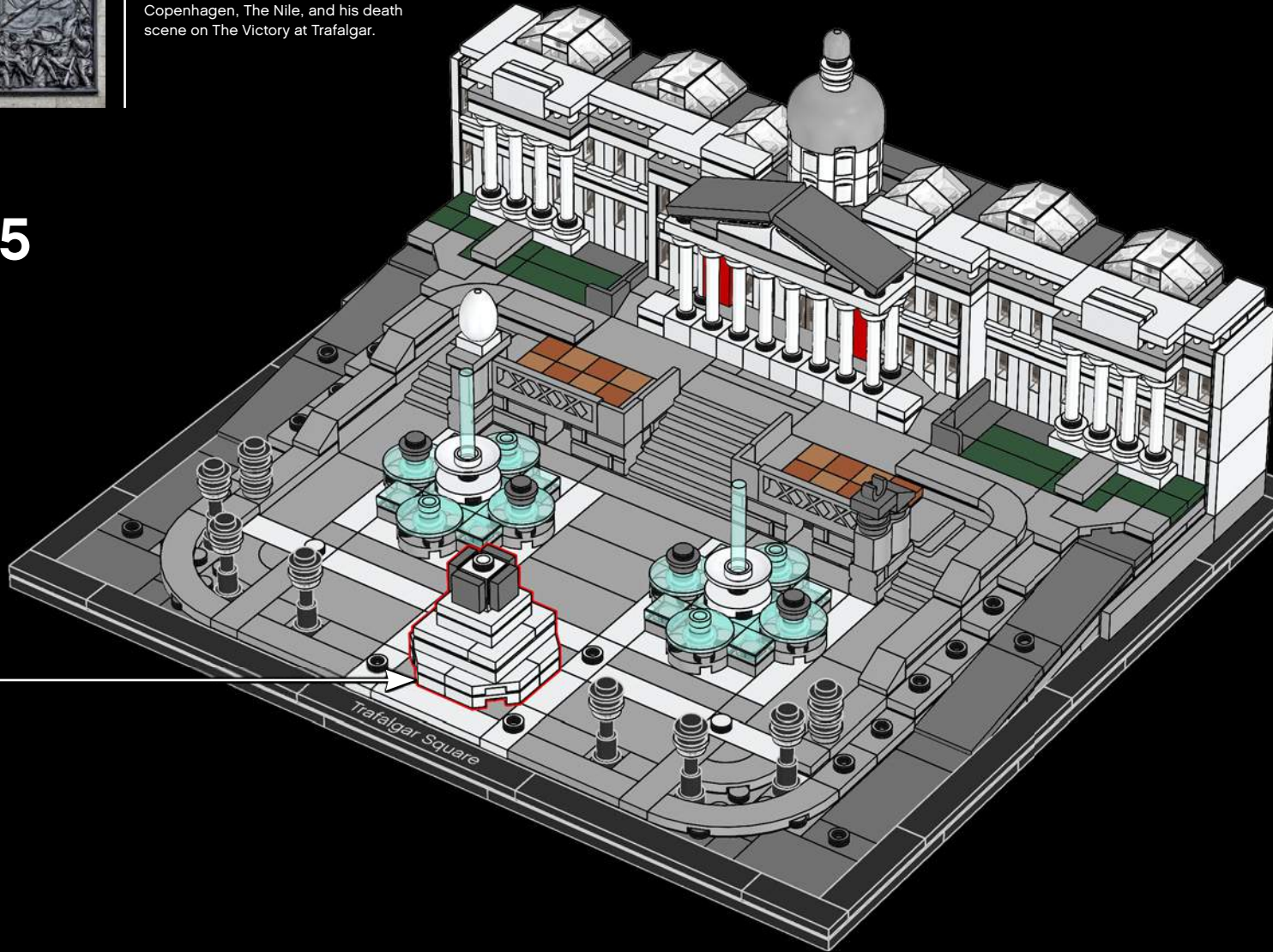

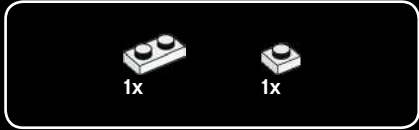

216



217



218

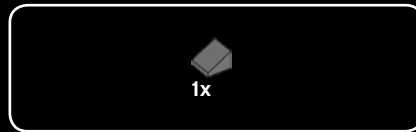
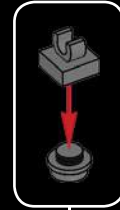

219



4x



The sculptor of the lions, Sir Edward Landseer, used a real lion that had died as the model, but it took so long to make the piece that the lion decomposed and thus the paws resemble a cat's more than a lion's. Also, a lion's back is actually convex, and not concave, when lying down.

220

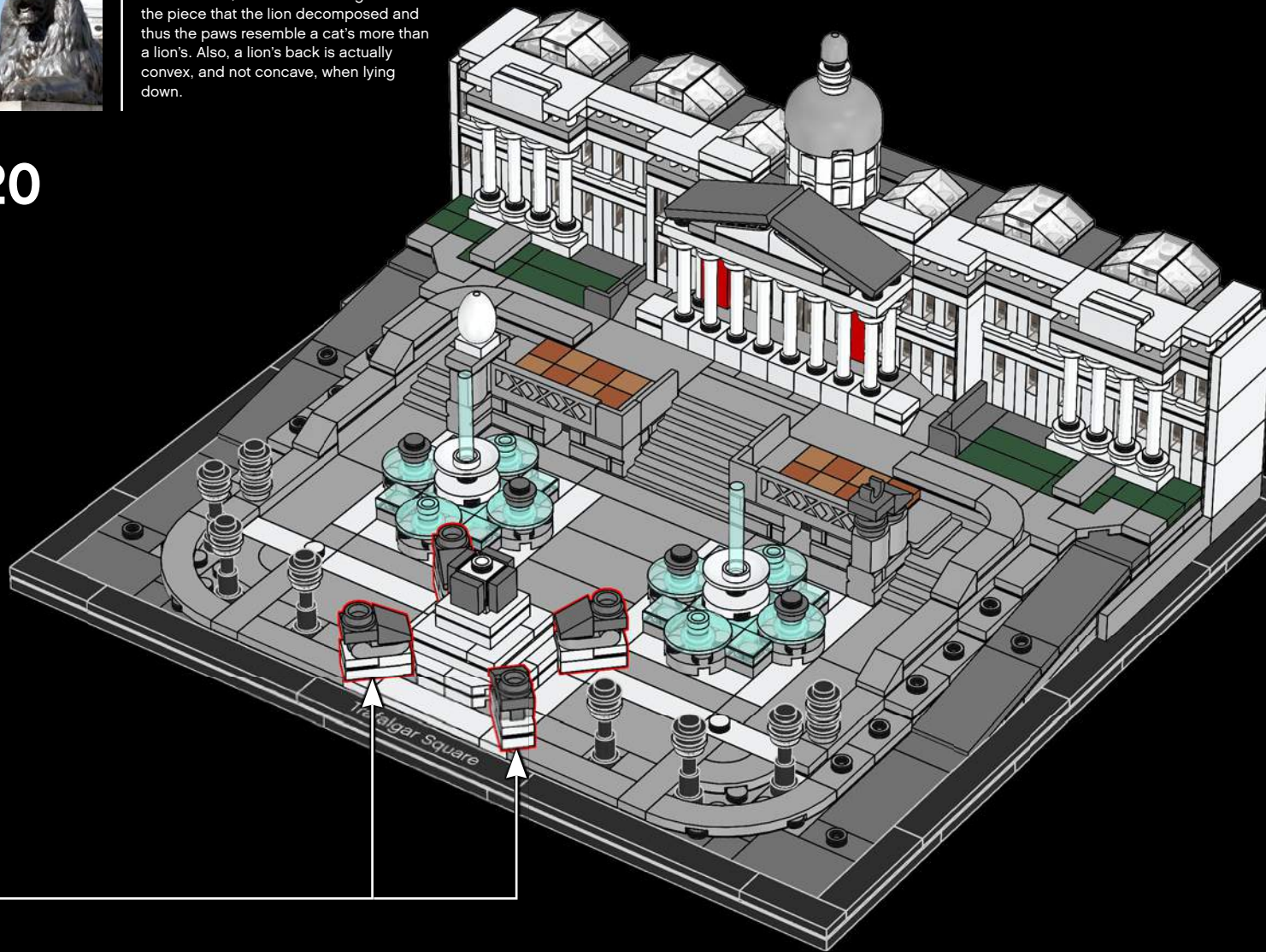





4x



2x



2x

# 221

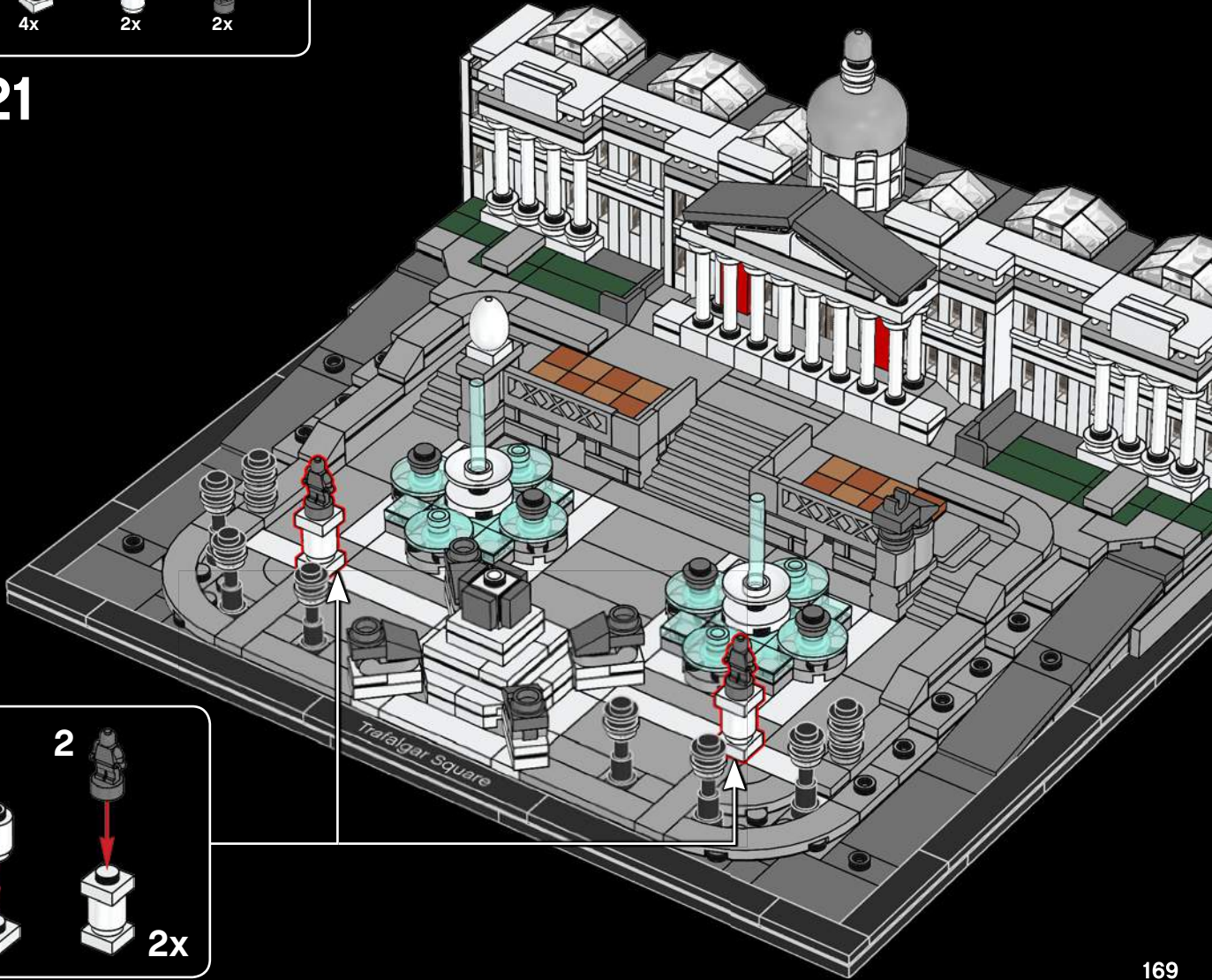

1



2



2x

2x      4x      2x

# 222



1      2

2x

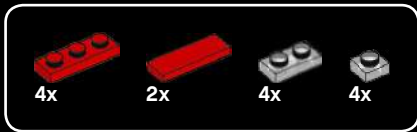

# 223



17 bus routes pass around the square, making it a central hub of London traffic.

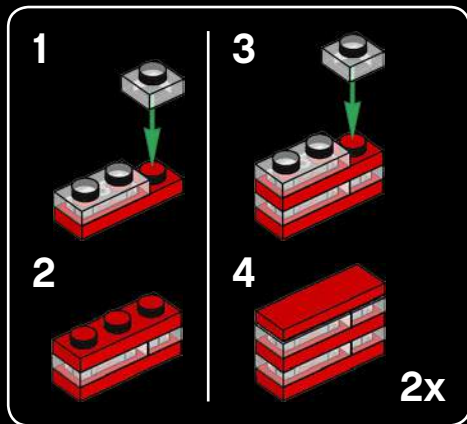
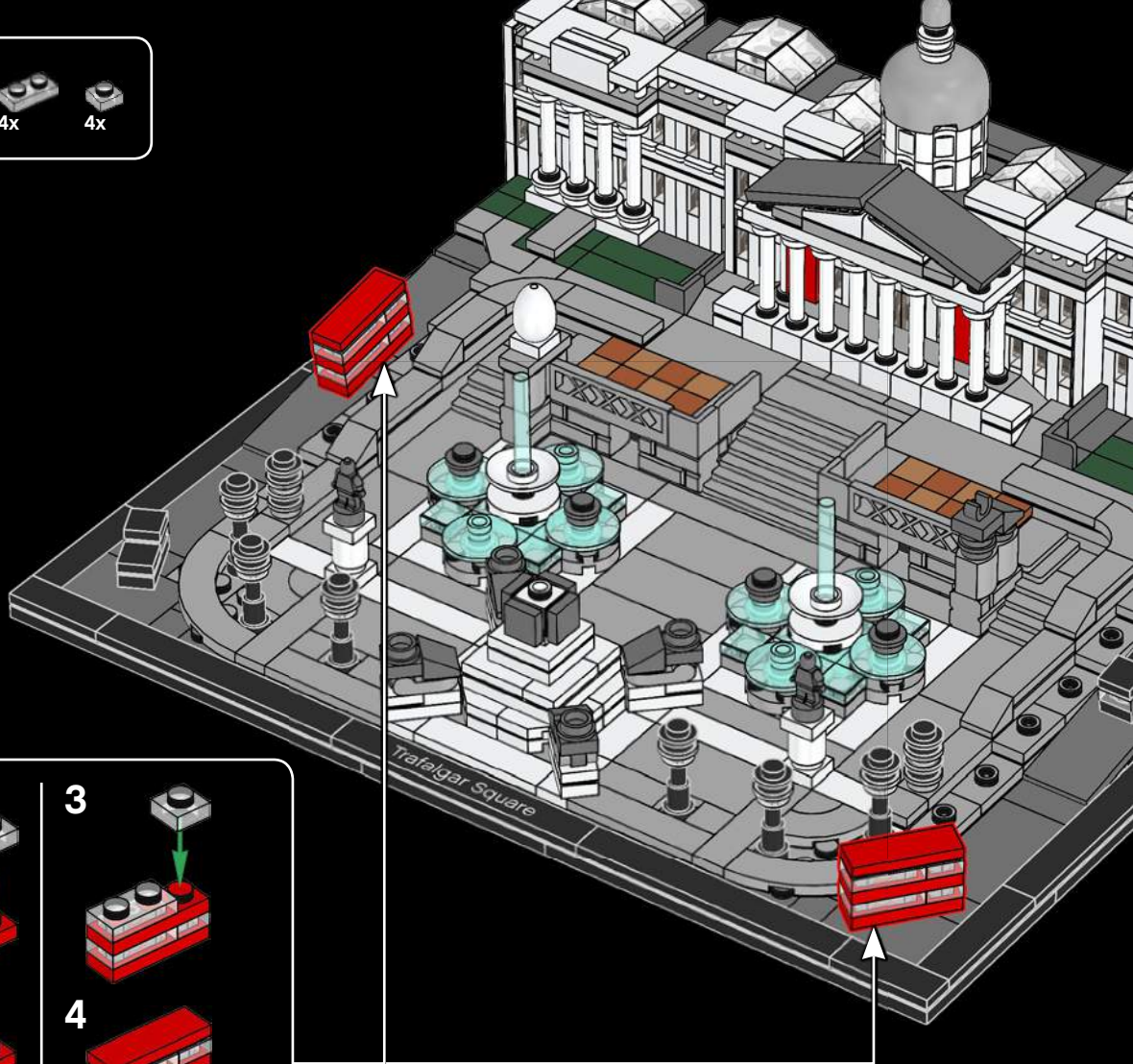



5x



10x



15x



10x



5x



5x

224

1



2



3



4



5x

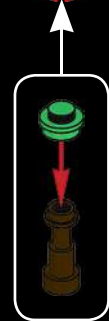

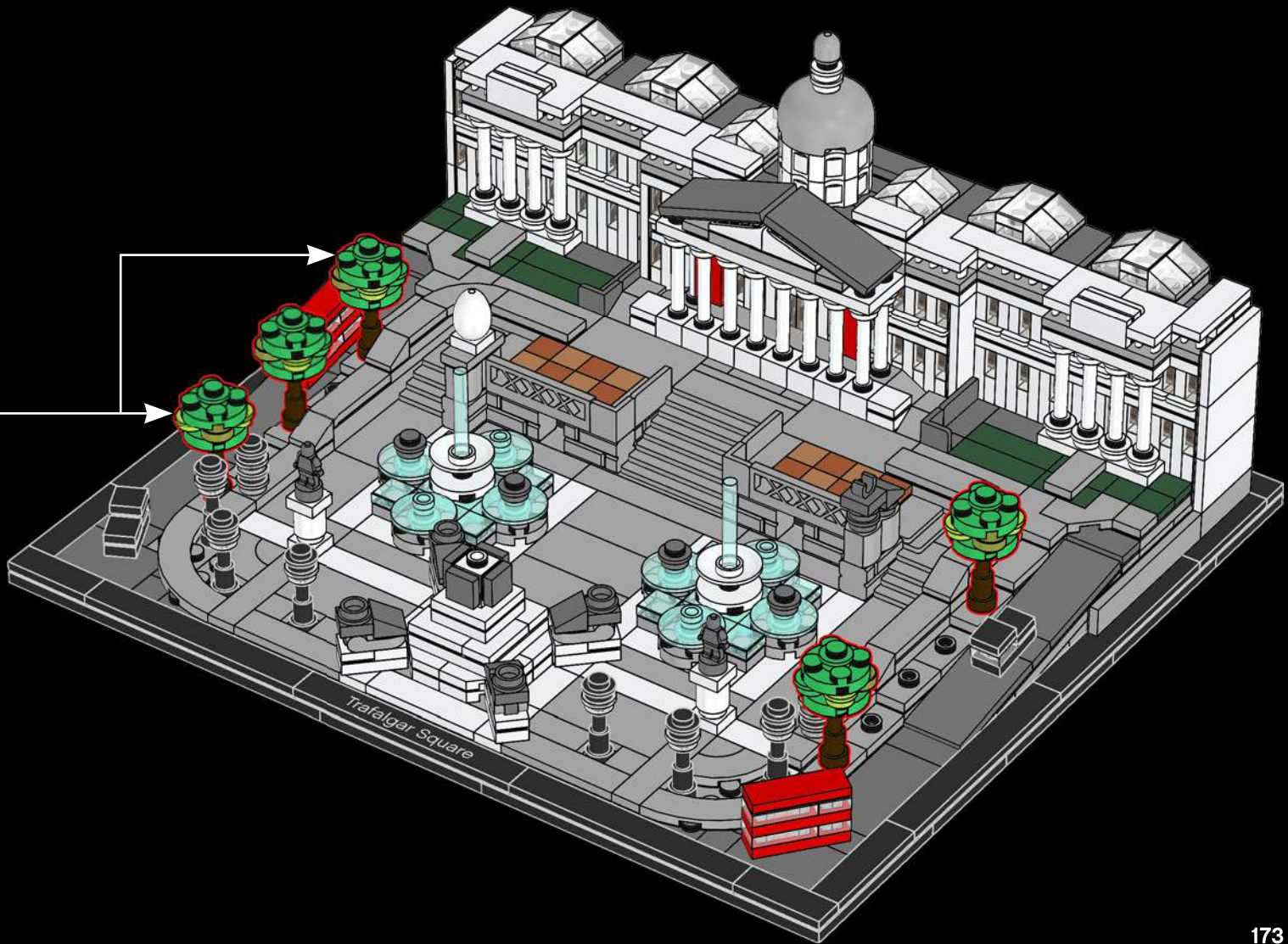



225

1

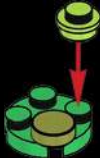

2



3



4

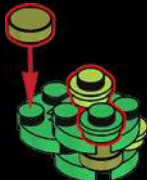

5

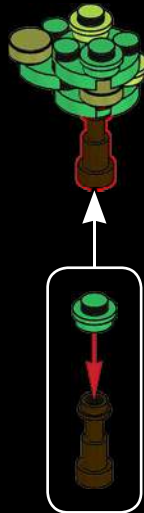

3x





2x



4x



4x



2x



2x



2x

226

1



2



3



4



2x

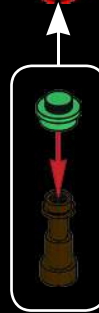





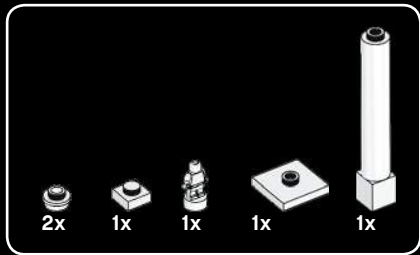

227

1



2



3





Trafalgar Square



# LEGO® Architecture – do you like it?

The LEGO Group would like your opinion on the new product you have just purchased. Your feedback will help shape the future development of this product series. Please visit:

**[LEGO.com/productfeedback](https://www.lego.com/productfeedback)**

By completing our short feedback survey, you will be automatically entered into a drawing to win a LEGO® prize.





Terms & Conditions apply.

## LEGO® Architecture

The LEGO® Architecture series creatively captures the essence of many of the world's most iconic landmarks while giving you an enjoyable and engaging LEGO building experience.

Whether your interest is in travel, design, history or architecture, these sets are a physical memento of a great trip abroad, a famous building you know well, or a city you still dream of visiting.

Every LEGO Architecture set is designed to be displayed. Much more than just a photo, building and displaying your model on your desk, in the bookcase or on the shelf, lets you be transported every time you admire the view.

Follow us on  

Adam Reed Tucker is the co-developer of the LEGO Architecture product line.



Celebrate the world of architecture  
and collect all the models

21046  
Empire State  
Building



21041  
Great Wall of China

21042  
Statue of Liberty



21030  
United States Capitol Building





21039  
Shanghai



21034  
London



21047  
Las Vegas



21044  
Paris



21028  
New York City



21043  
San Francisco

# References

*Pictures -*

© GettyImages

Customer Service  
Kundenservice  
Service Consommateurs  
Servicio Al Consumidor  
[LEGO.com/service](http://LEGO.com/service) or dial

  
00800 5346 5555 ;   
1-800-422-5346 ; 



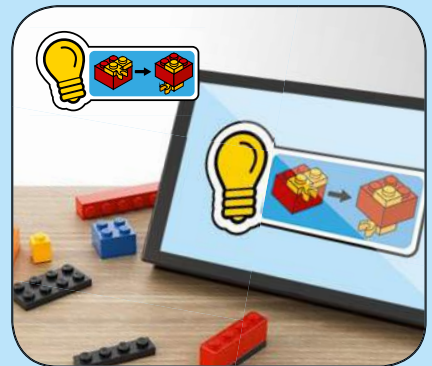

1x 6073432  
2x 306201  
31x 6168642  
1x 6143595  
2x 6254609  
86x 302401  
1x 6253635  
8x 654101  
10x 307001  
2x 6218841  
24x 6167602  
2x 6224811  
1x 6073345

1x 4111971  
2x 4538353  
16x 4613256  
7x 4547489  
2x 474001  
2x 6093053  
11x 6051511  
10x 306901  
54x 302301  
4x 6176240  
1x 4585458  
2x 6023804  
2x 6218823  
2x 6070698

3x 4249563  
18x 6093526  
10x 6218822  
2x 6126046  
1x 6210404  
3x 302201  
6x 6058329  
4x 6168612  
2x 242001  
2x 6263181  
8x 362201  
6x 362301  
2x 4558168

2x 4258358  
6x 6156667  
3x 302101  
2x 300201  
2x 4597131  
14x 243101  
12x 371001  
4x 301001  
3x 6104805  
9x 302001

3x 366601  
6x 663601  
6x 300901  
2x 4243812  
2x 617901  
2x 346001  
4x 416201  
1x 6054973  
4x 4514842

10x 6143431  
2x 302421  
2x 4569056  
5x 306921  
4x 300421  
2x 4515365  
4x 362321  
2x 4533742  
4x 371021  
8x 6240030  
24x 6245250  
6x 6252041  
8x 6240204  
4x 6251294

8x 6240225  
8x 6254256  
8x 6245307  
4x 6244910  
2x 6170187  
1x 6253790  
1x 6253837  
8x 4143005  
18x 4183133  
1x 6208286  
25x 4569058  
23x 403228  
6x 6055171  
4x 6192250  
4x 4650622

6x  
4538456

10x  
614126

4x  
307026

1x  
302426

2x  
4121715

2x  
302326

2x  
6192309

2x  
302226

4x  
4558170

2x  
300226

4x  
243126

1x  
6078886

190

1x  
395726

9x  
416226

1x  
6265021

3x  
303226

2x  
6057902

5x  
303026

4x  
302826

56x  
6252039

4x  
6240219

1x  
6212288

2x  
4211525

2x  
6176433

8x  
4521921

15x  
4211399

2x  
4558953

1x  
6133883

2x  
4215513

2x  
4211389

2x  
4211535

16x  
4211415

2x  
6227897

4x  
6225246

8x  
4211475

2x  
4550325

11x  
6066097

14x  
6146223

2x  
4211388

8x  
6000066

12x  
4211414

6x  
4211397

2x  
6185676

1x  
4612077

4x  
6163990

14x  
4211356

2x  
4599498

12x  
4211445

2x  
6230229

11x  
4560183

1x  
4211385

4x  
4211393

5x  
4211549

4x  
4211438

2x  
4612621

2x  
6163989

10x  
4211353

2x  
6065824

2x  
6177078

4x  
4211387

2x  
4654577

1x  
6263183

6x  
4211429

8x  
4558169

4x  
4211396

8x  
6071299

5x  
4211452

1x  
4211838

2x  
4211462

4x  
4514846

2x  
4211522

2x  
4211360

2x  
4211486

  
2x  
6146192

  
11x  
4210633

  
4x  
4210719

  
5x  
4504378

  
5x  
6071226

  
2x  
6025235

  
8x  
4210848

  
4x  
4210639

  
12x  
6092572

  
2x  
6146225

  
10x  
4211052

  
2x  
4211063

  
2x  
4211094

  
6x  
4211133

  
2x  
6187008

  
8x  
4560184

  
1x  
4210651

  
1x  
4211056

  
1x  
4243831

  
2x  
4210998

  
1x  
4211008

  
1x  
4211134

  
4x  
4257526

  
1x  
6138682

  
4x  
6060800

  
4x  
4523145

  
8x  
6092587

  
2x  
6146221

  
3x  
6132769

  
2x  
4514554

  
2x  
4113988

  
1x  
4609726

  
1x  
6092591

  
4x  
4496699

  
2x  
4528604

  
4x  
4507045

  
1x  
6047415

  
1x  
4633881

  
2x  
6114515

  
13x  
6047015

  
8x  
6177146

  
2x  
6008297

  
10x  
4538950

  
1x  
6240515

  
Customer Service  
Kundenservice  
Service Consommateurs  
Servicio Al Consumidor  
LEGO.com/service or dial

  
: 00800 5346 5555  
: 1-800-422-5346

