



CITY

4429



1

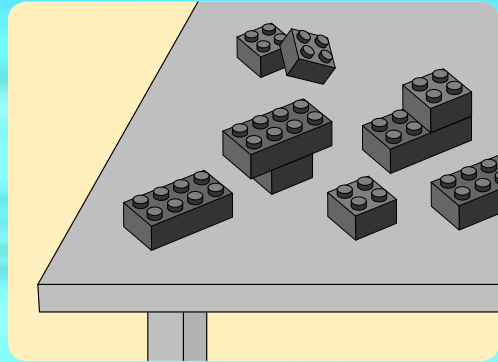
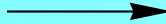
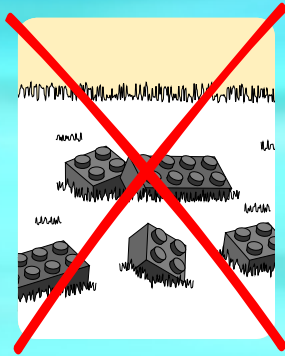

2

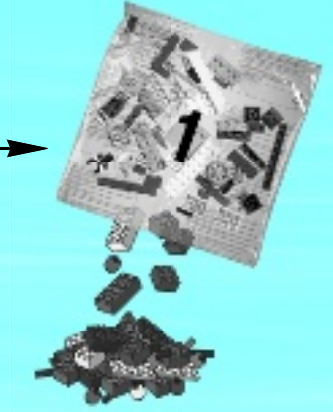



1



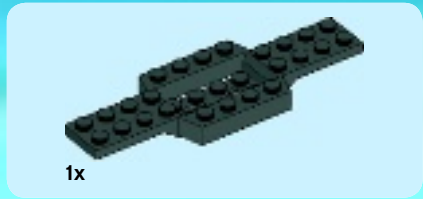

1

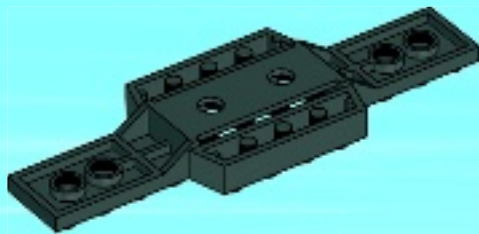



2x

2

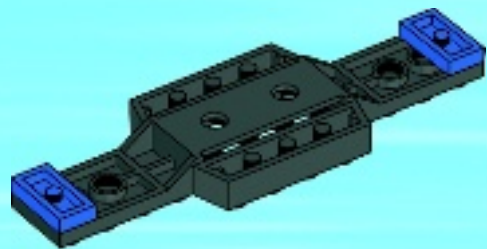

2x

3

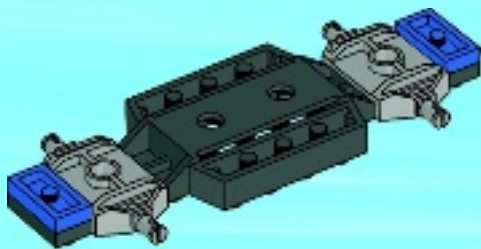



4

1



2



3



4



5

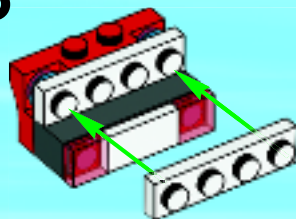

6



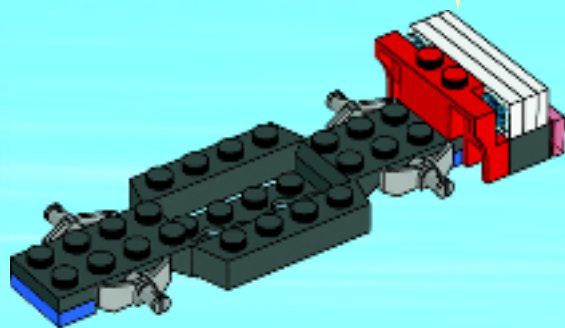



1x

5

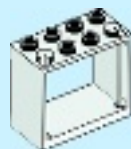
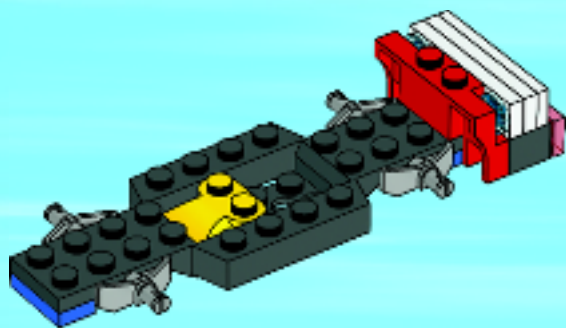

1x

6

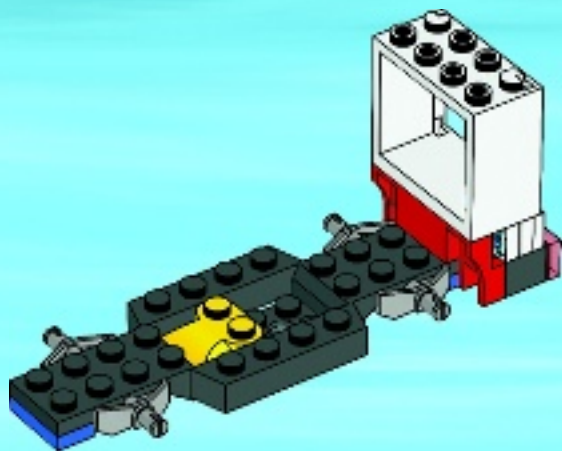



2x

7



2x

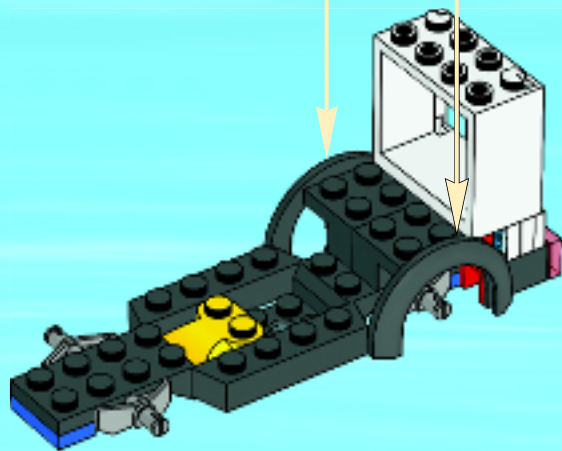

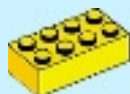

1x

8

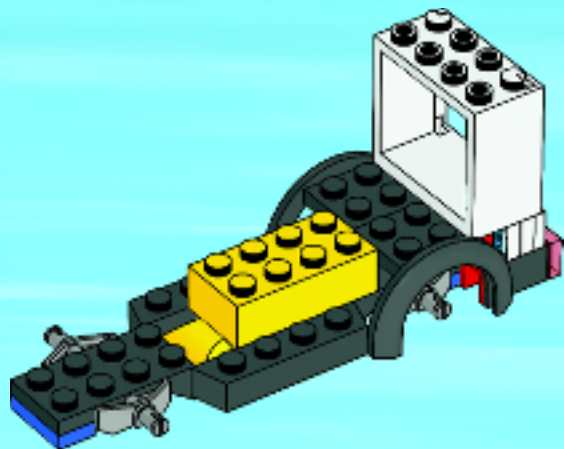

2x

9

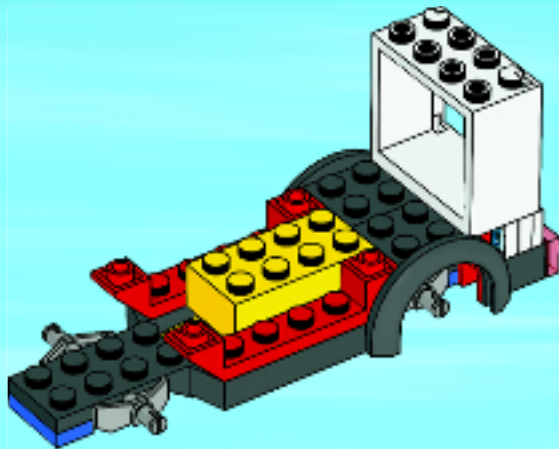



2x

10

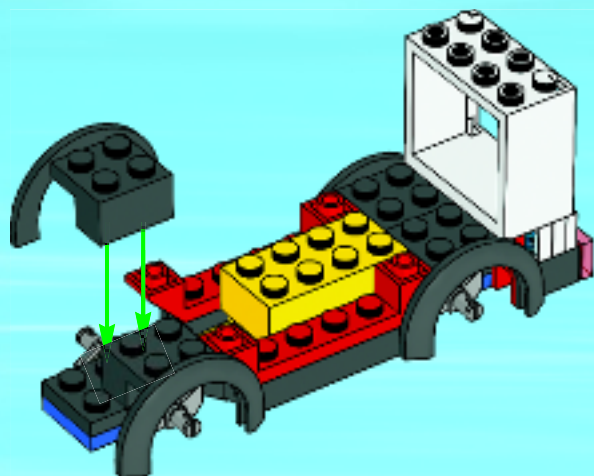



1x



1x



1x



2x

11

1

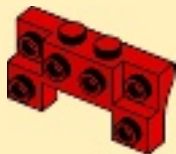

2



3

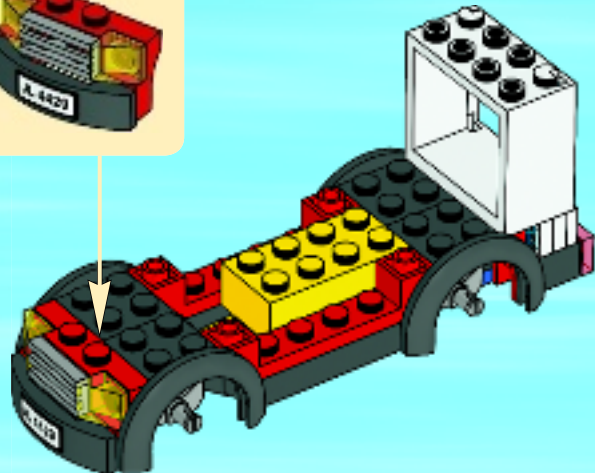



2x



2x

12

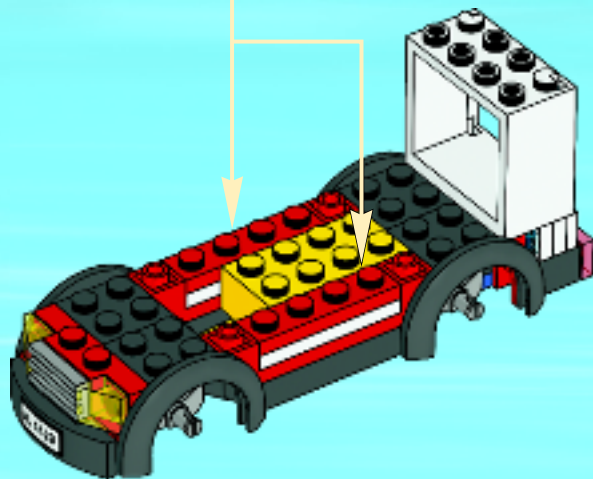
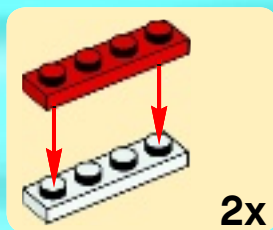



1x



1x

13

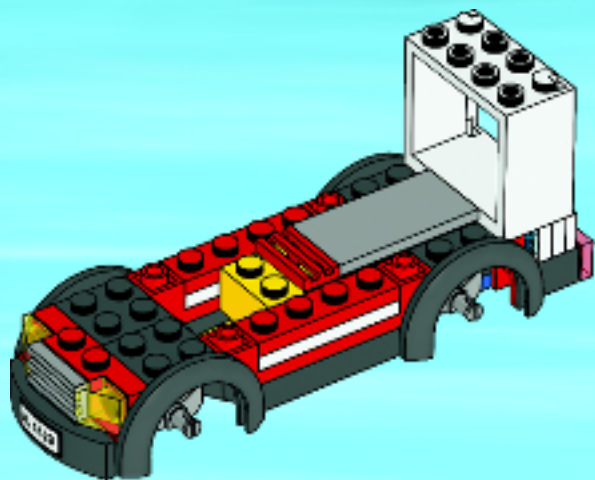



1x



1x

14

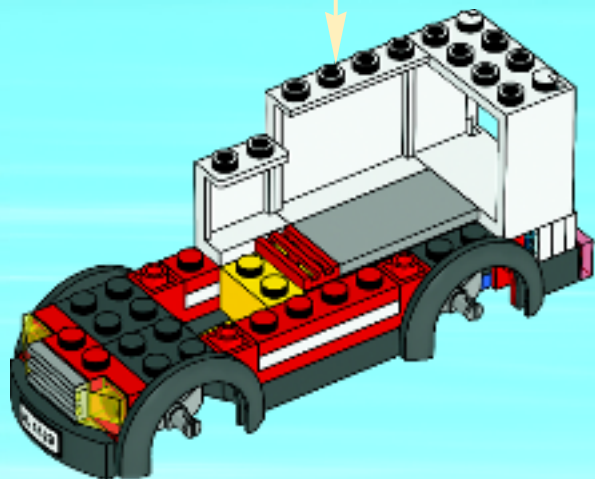
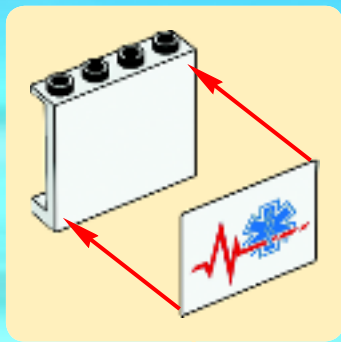

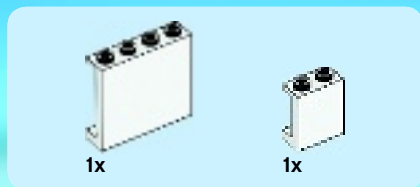

15

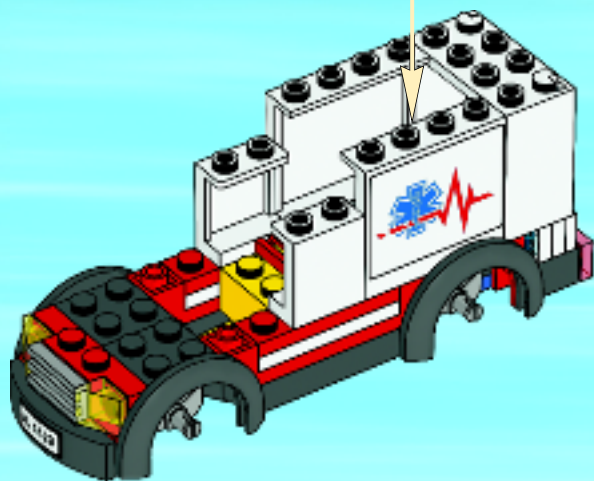
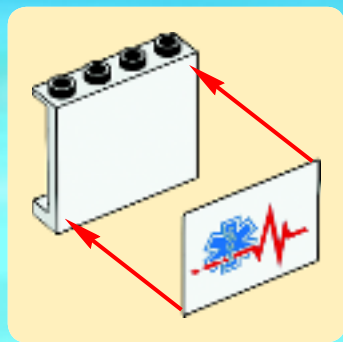



1x

16

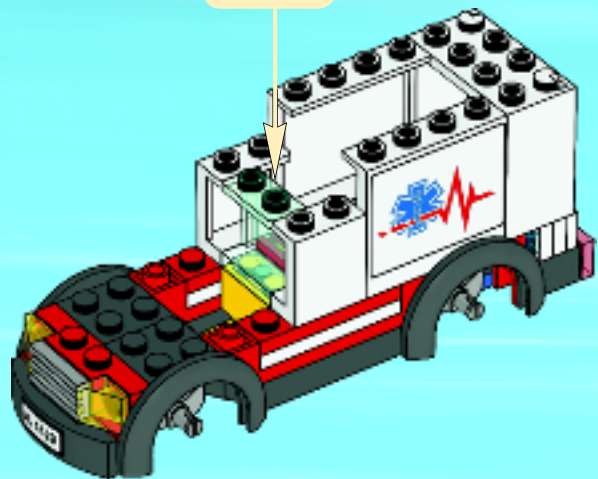

1x



1x

17

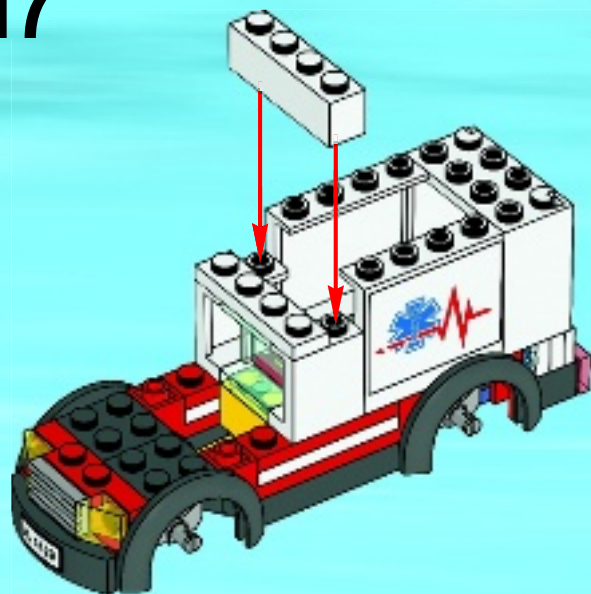



2x



2x

18

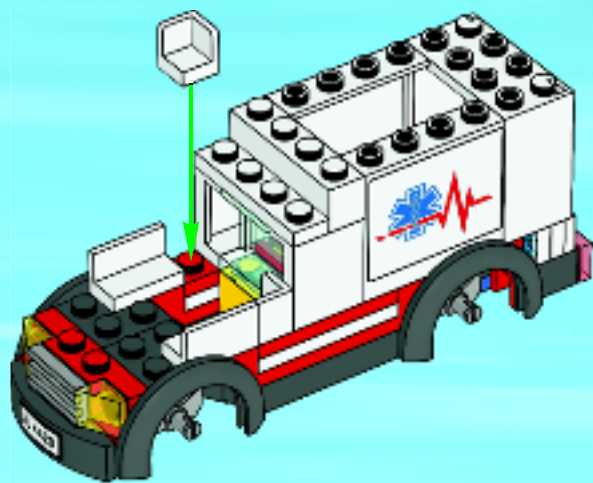

1x

19

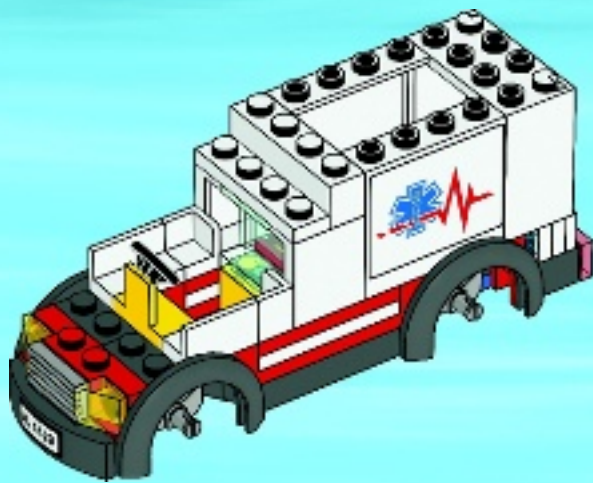



1x

20

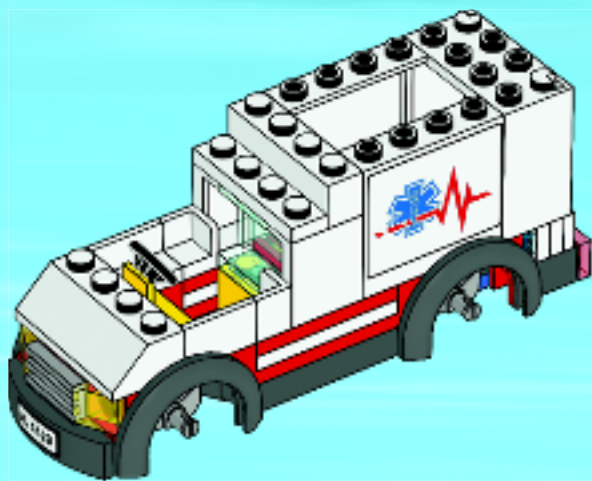

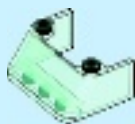

1x

21

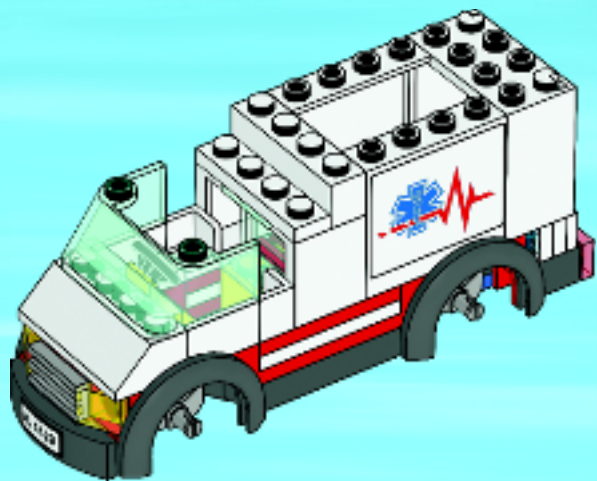

1x

22

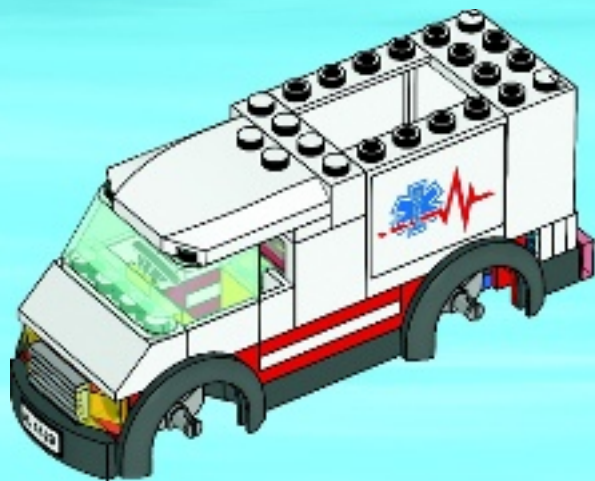



2x

23

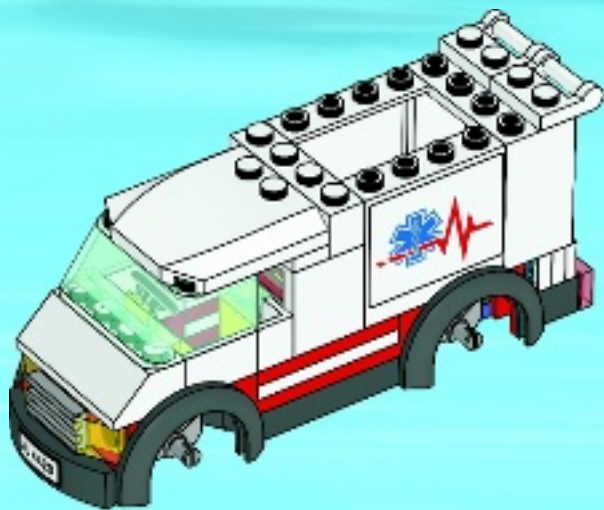



2x



1x

24



2x



2x

25

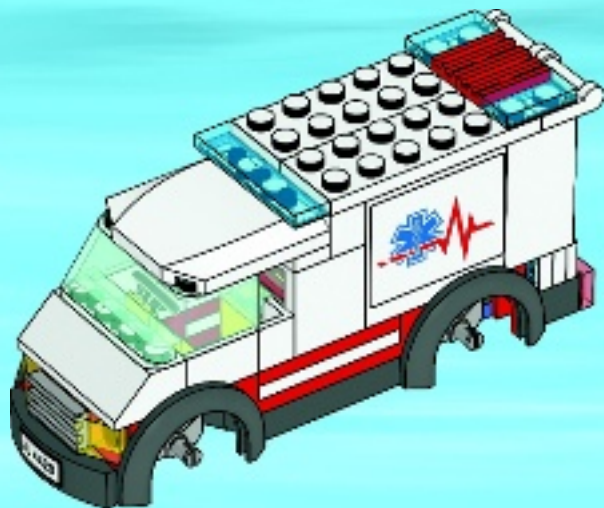



1x



1x



2x



1x



1x

26

1



2



3

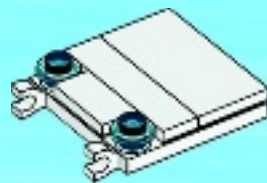

4

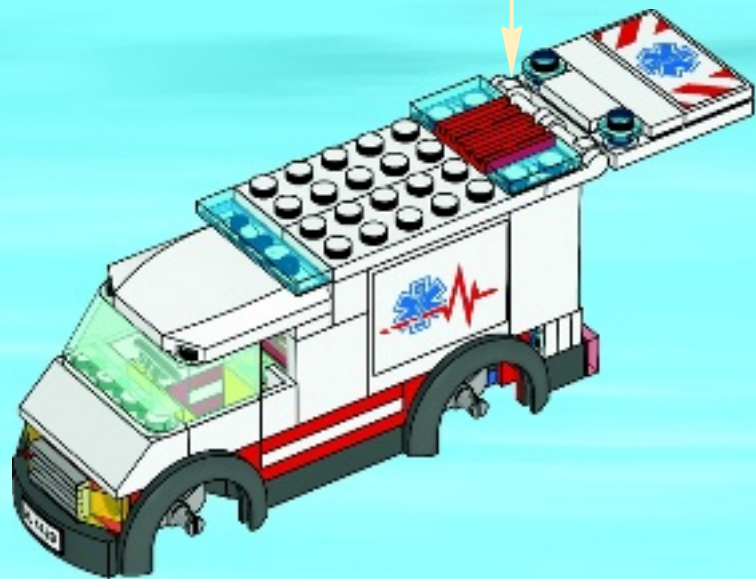
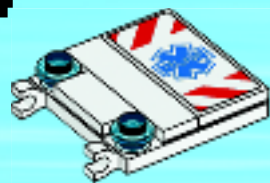

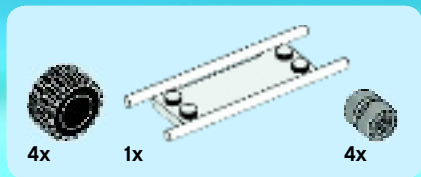

27

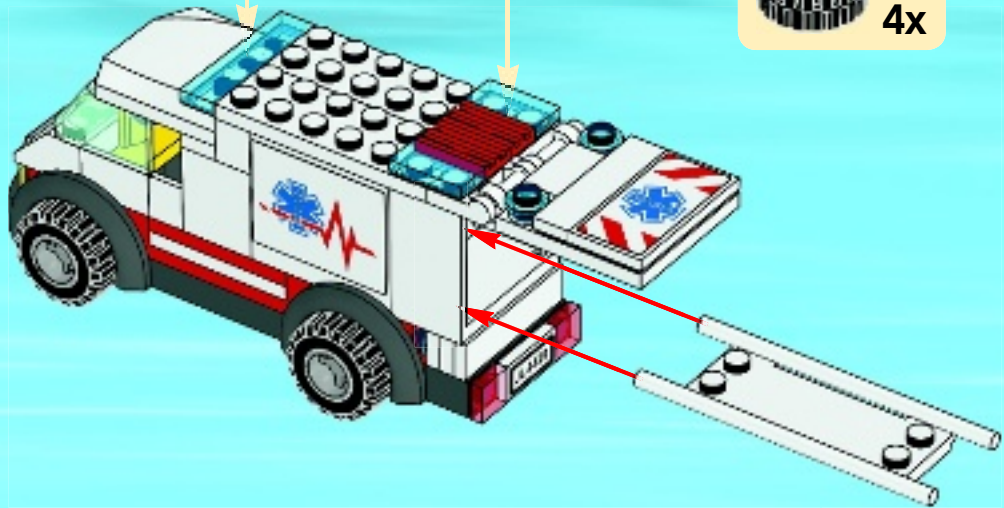

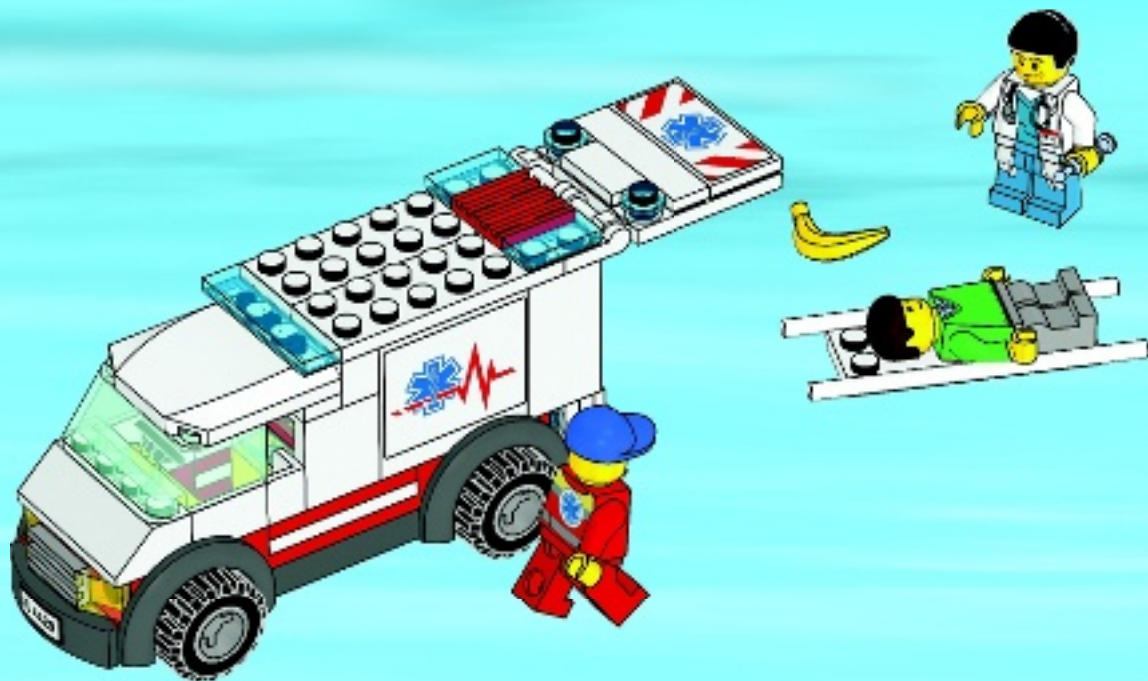



WIN!

Go to www.LEGOsurvey.com/product to fill out a survey for a chance to win a cool LEGO® Product.

No purchase necessary.

Open to all residents where not prohibited.



www.LEGOsurvey.com/product

GEWINNE!

Nimm an der Umfrage auf www.LEGOsurvey.com/product teil und hab die Chance ein cooles LEGO® Produkt zu gewinnen!

Die Teilnahme am Gewinnspiel führt zu keinerlei Kaufverpflichtungen. Teilnahme in allen nicht ausgeschlossenen Ländern möglich.

WIN!

Ga naar www.LEGOsurvey.com/product, vul een enquêteformulier in en maak kans op een cool LEGO® product.

Geen aankoopverplichting. Iedereen mag deelnemen, uitgezonderd ingezetenden van landen waar een enquêteverbod geldt.

GAGNE!

Visite www.LEGOsurvey.com/product pour répondre à un questionnaire et avoir une chance de gagner un produit LEGO® très cool!

Aucune obligation d'achat. Ouvert à tous les résidents des pays autorisés.

当てよう!

www.LEGOsurvey.com/product にアクセスして、アンケートにご記入ください。当選者にはレゴ®製品を差し上げます。

お買い上げの必要はありません。禁止されていない限り、すべての皆様にご利用いただけます。



www.LEGO.com

6012823

LEGO and the LEGO logo are trademarks of the LEGO Group. ©2012 The LEGO Group.