

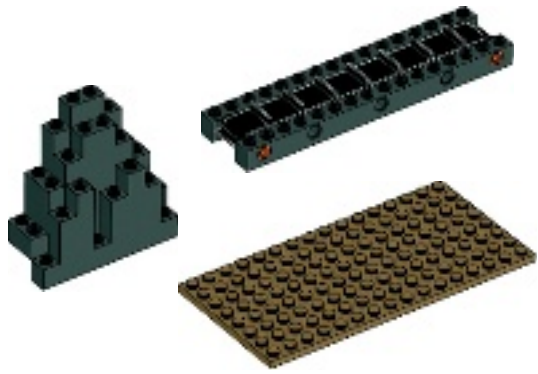

CITY

4204





+



4



1x



1x



2x

1

1



2

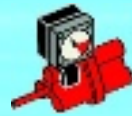

3

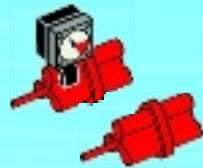

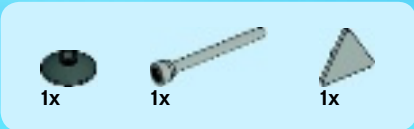

2

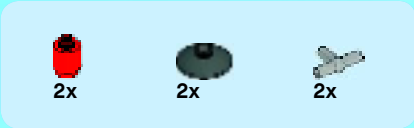
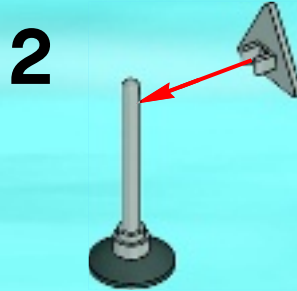
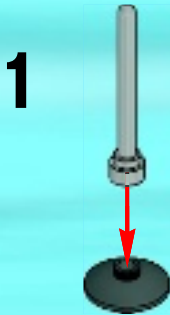

3



2x

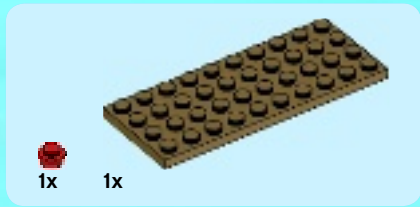
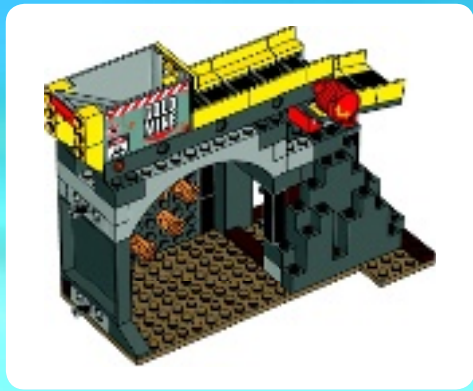

1



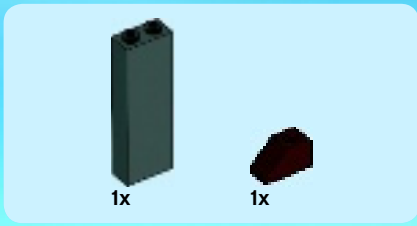

2

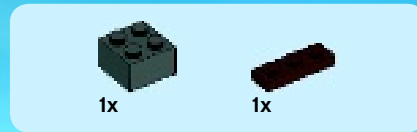
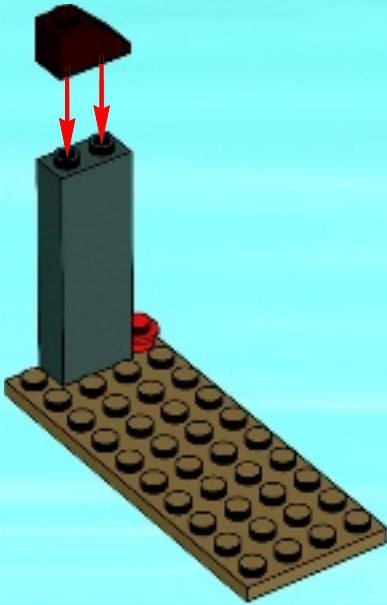

3

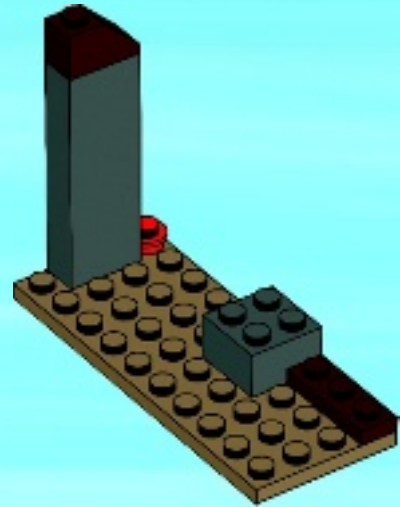

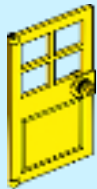

1x



1x

4

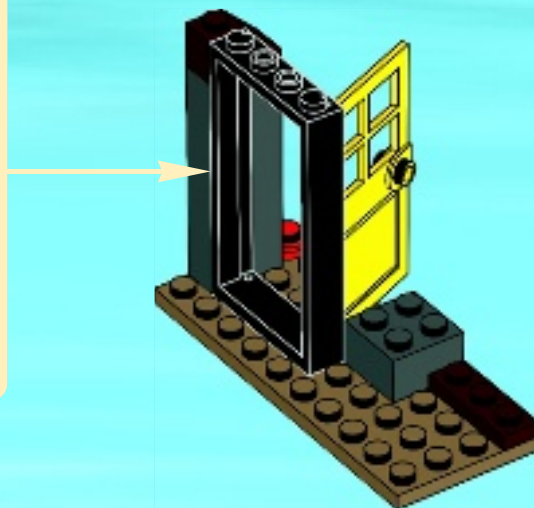
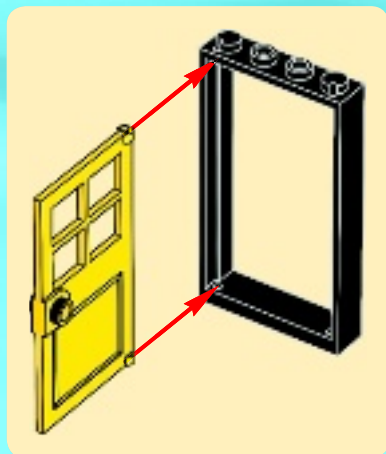

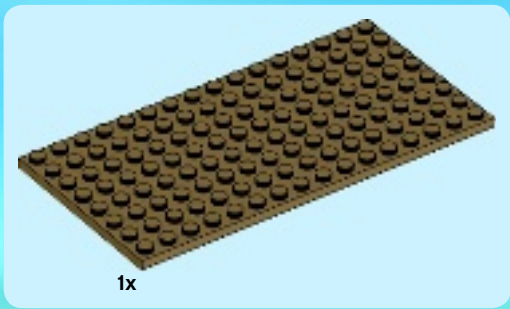

5

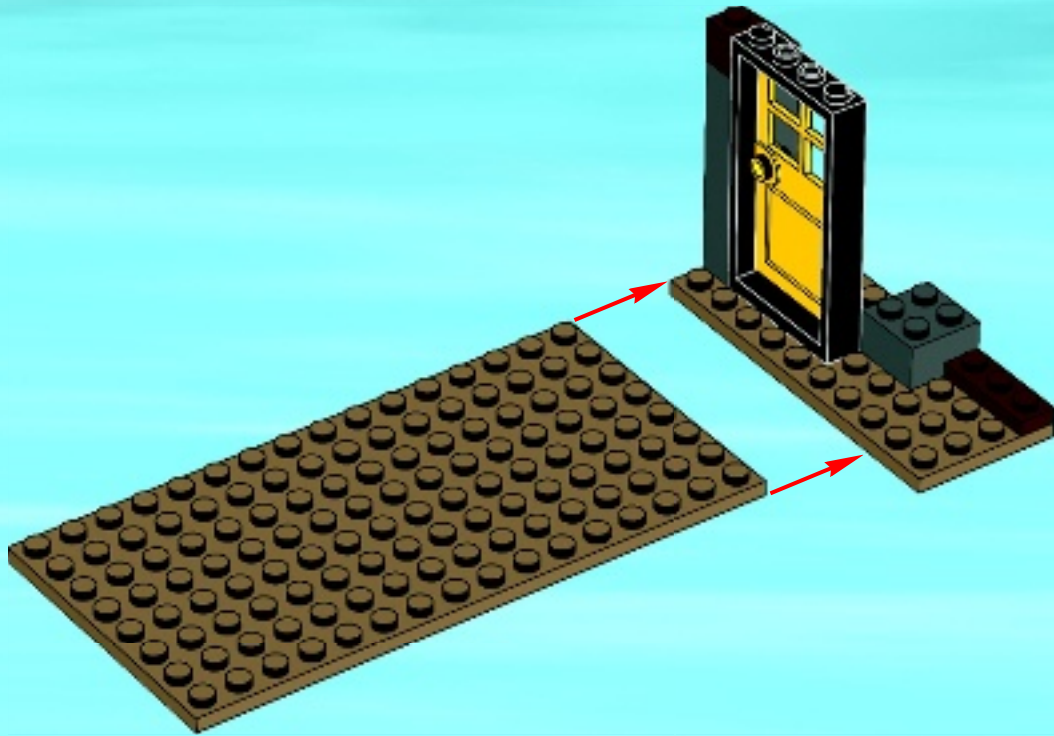

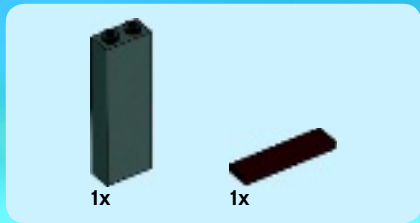

6

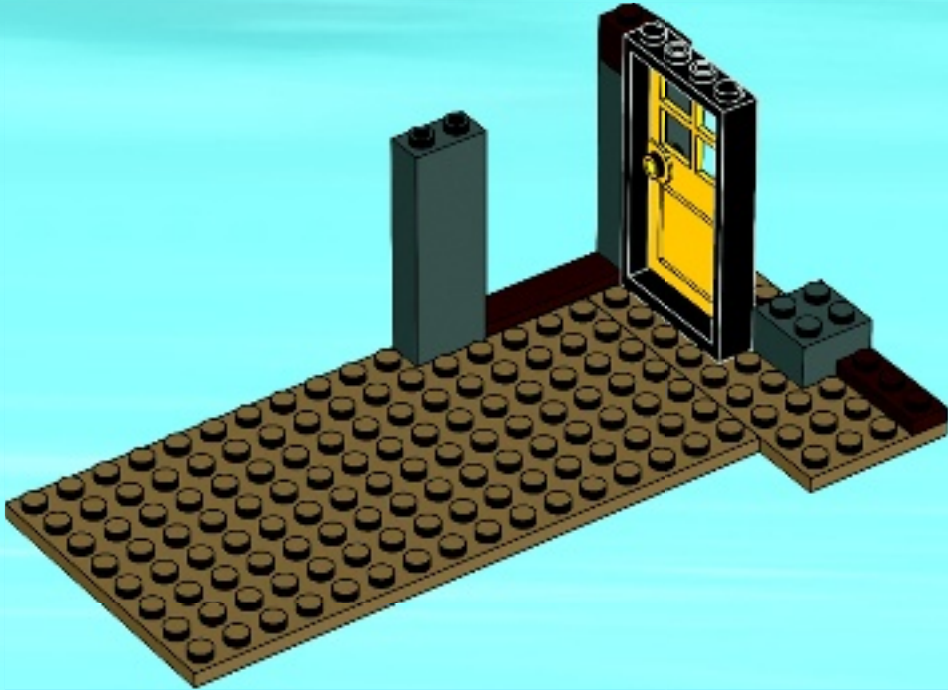



1x



1x

7

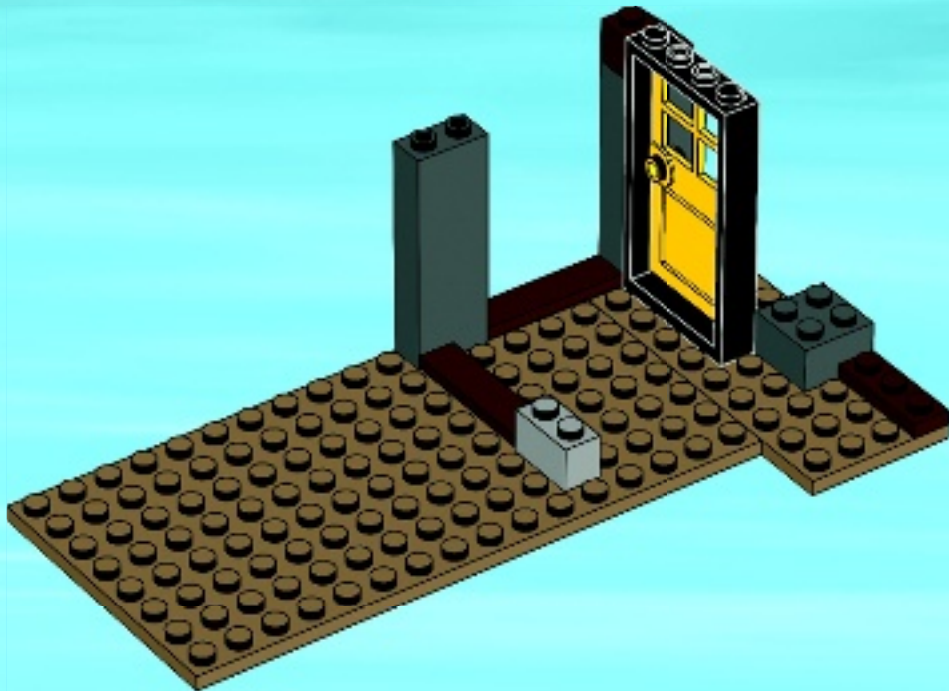

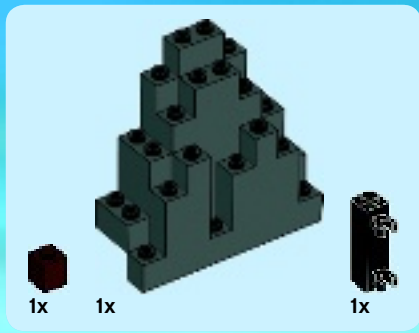

8

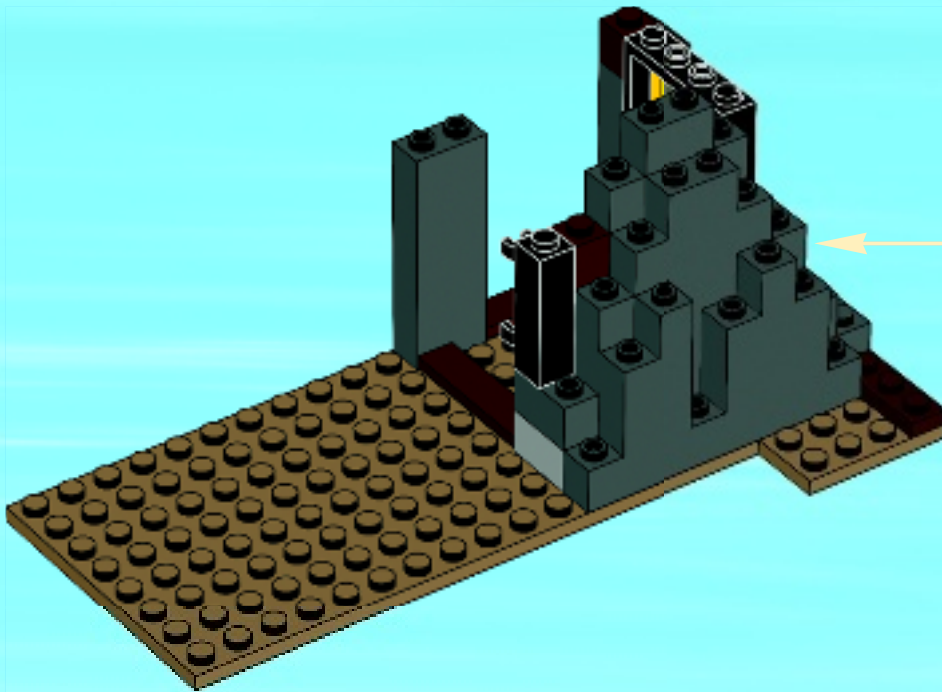
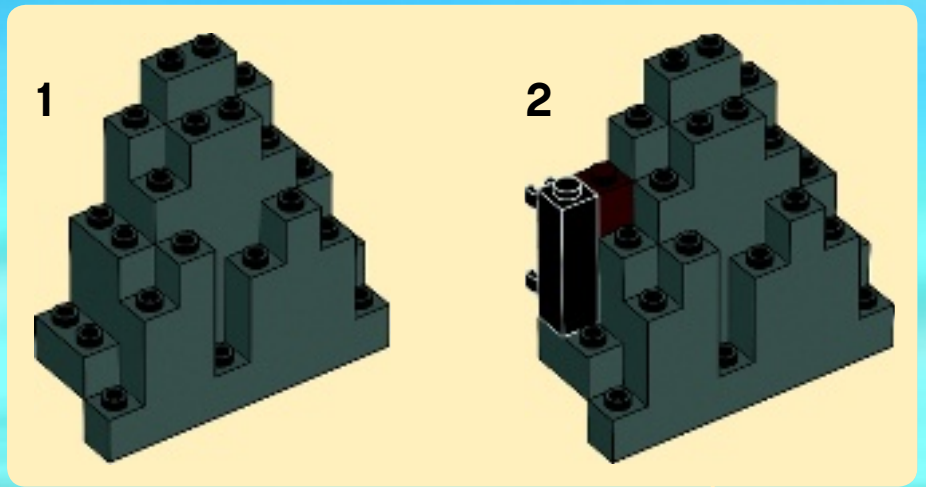



1x

9

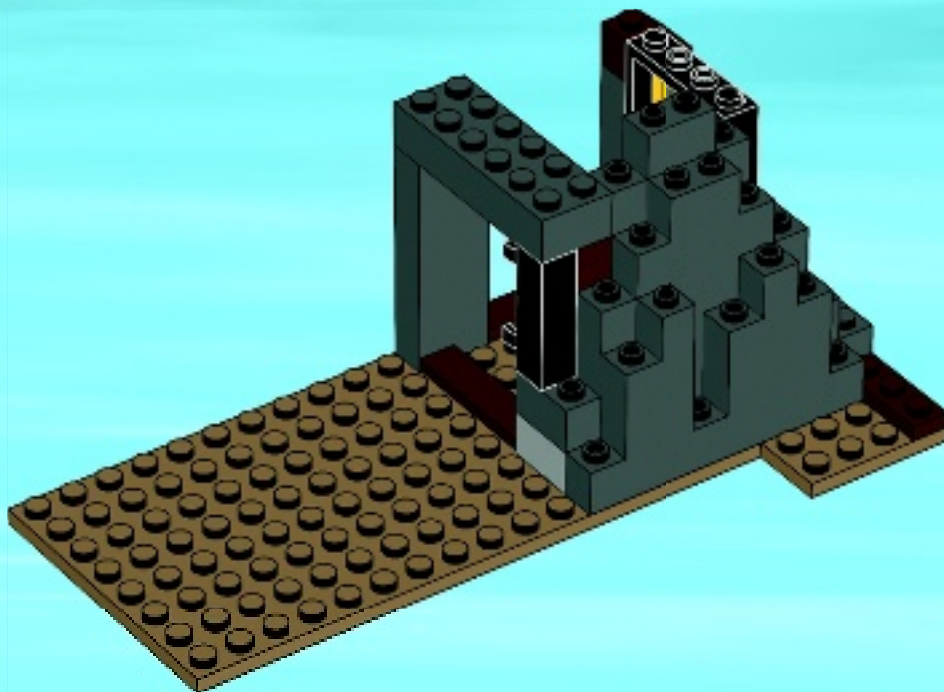

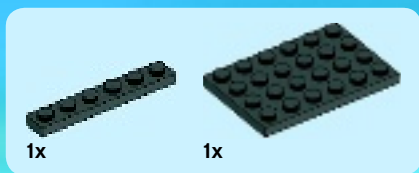

10

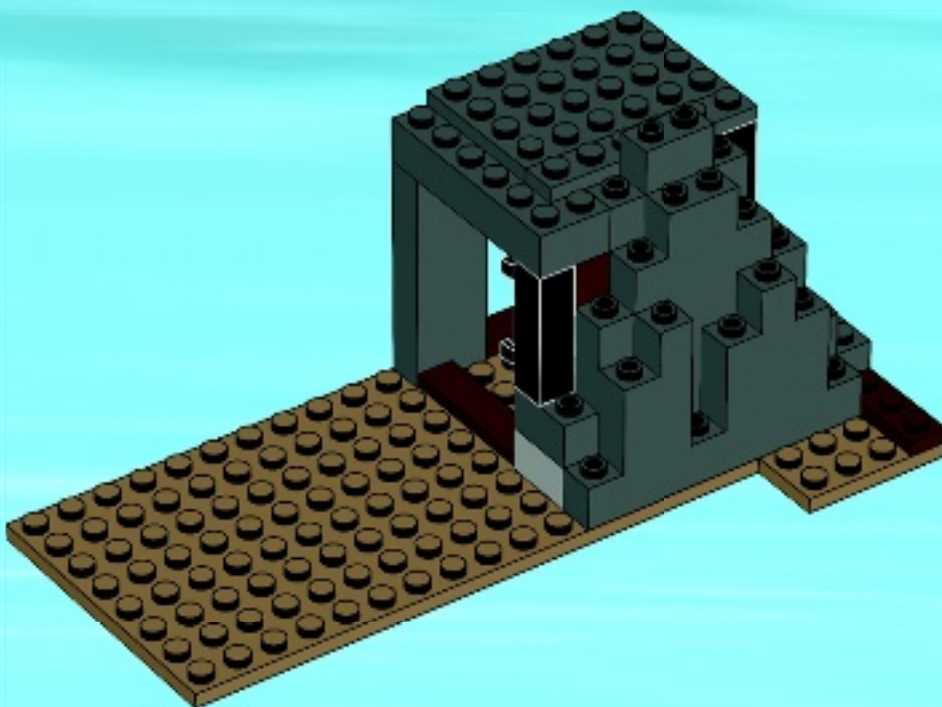



1x



1x

11

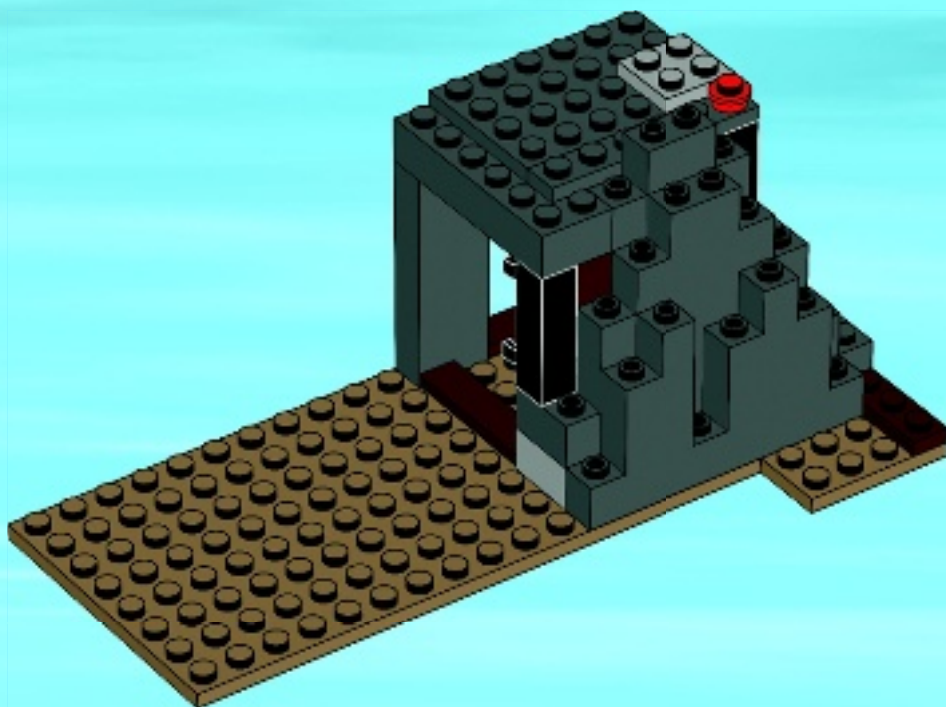



1x



1x



1x

12

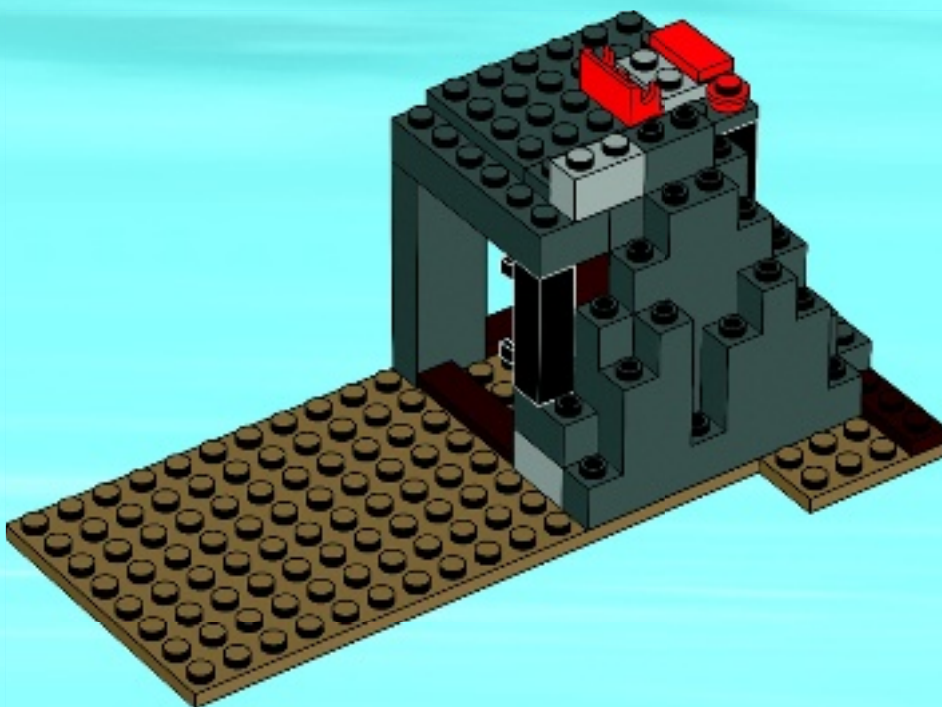



1x



1x



1x



1x



2x



2x

13

1



2

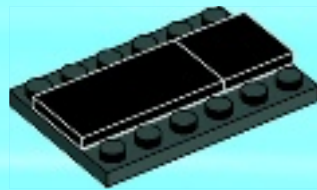

3

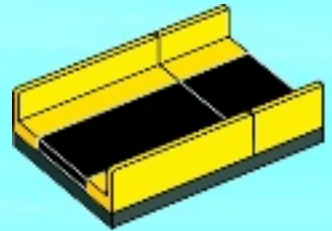



4

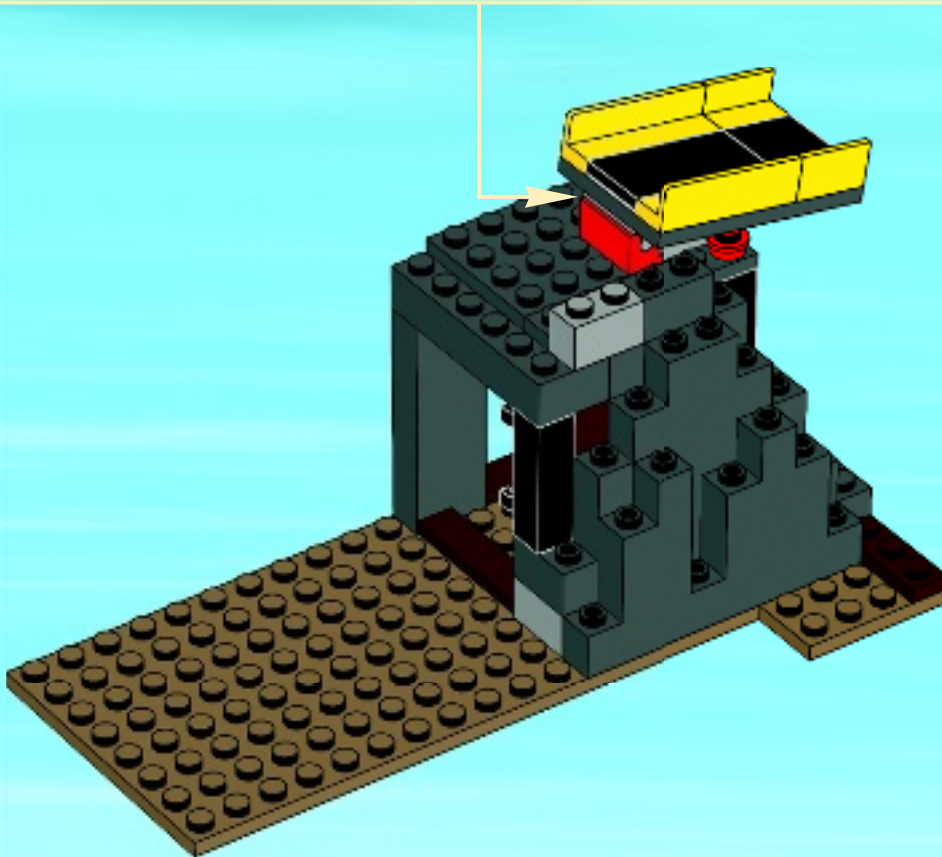
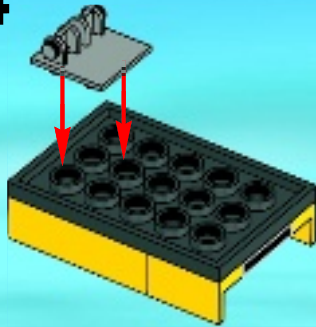

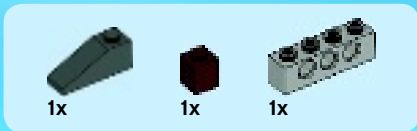

14

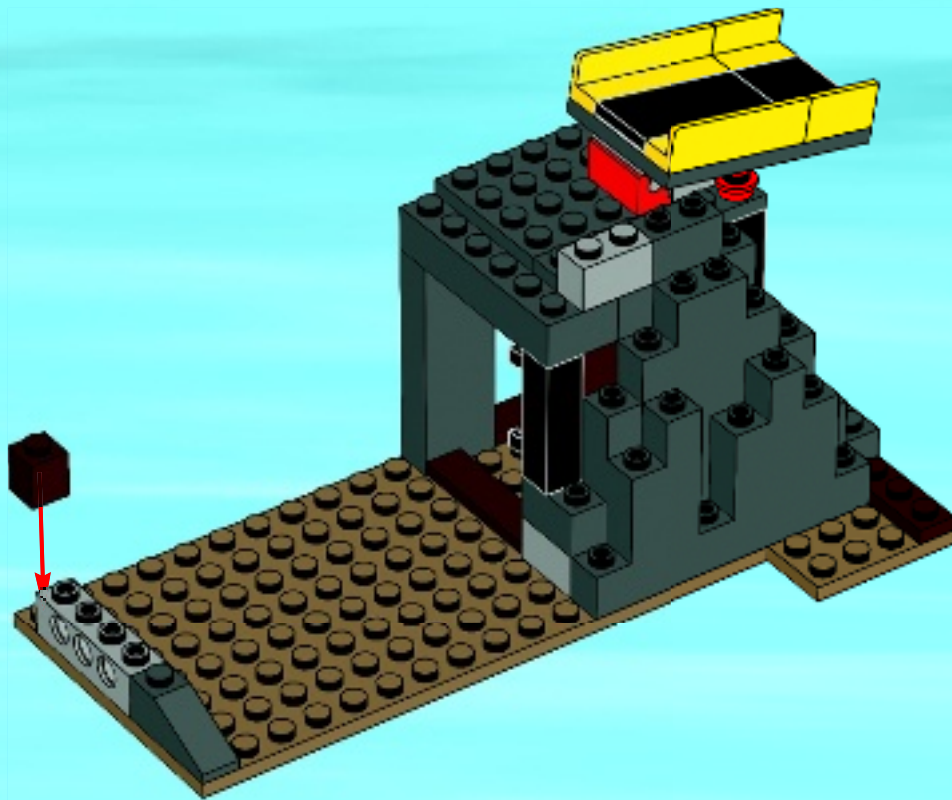



1x

15

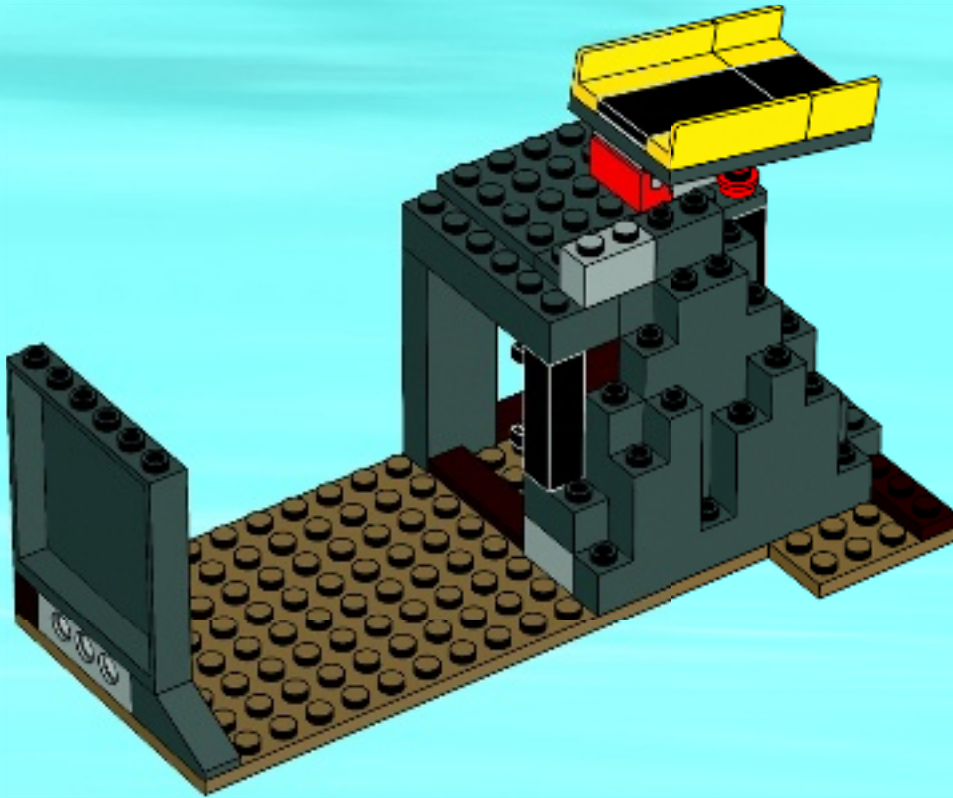

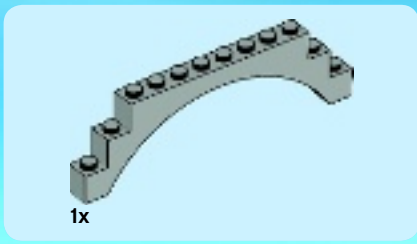

16

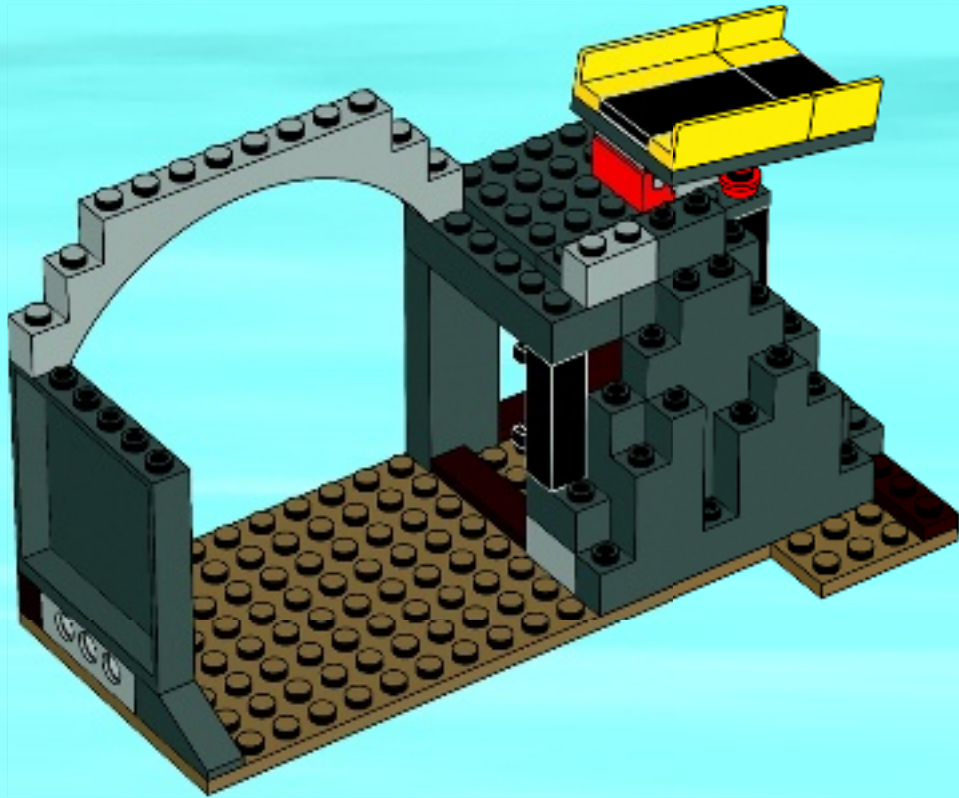



1x



1x

17

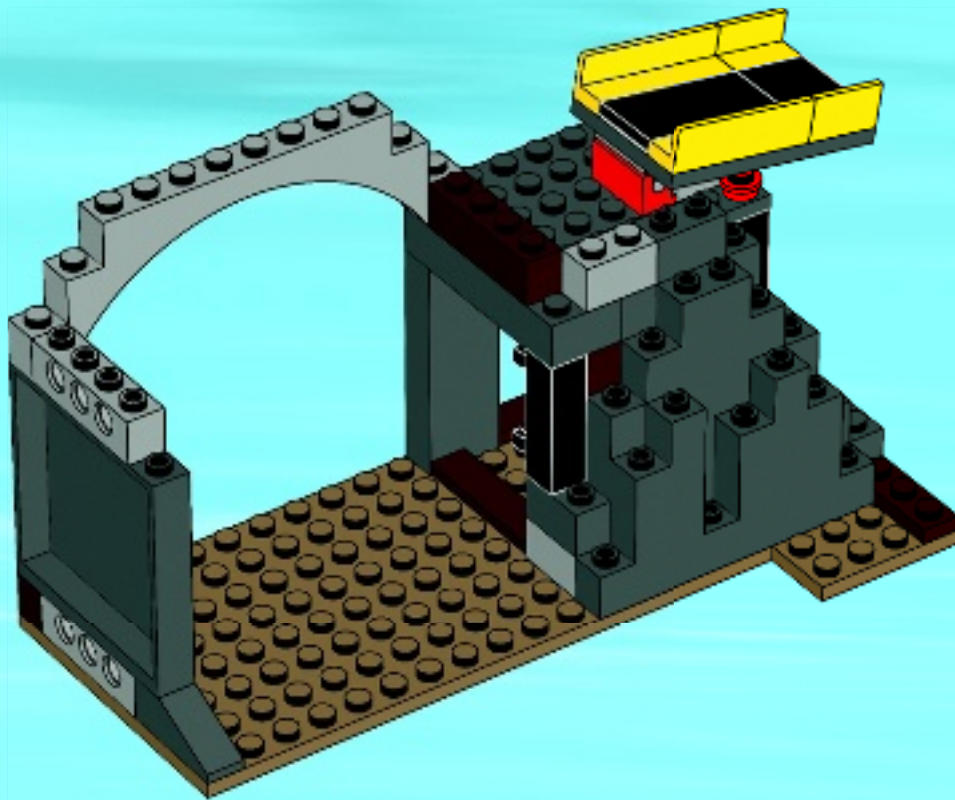



2x

19

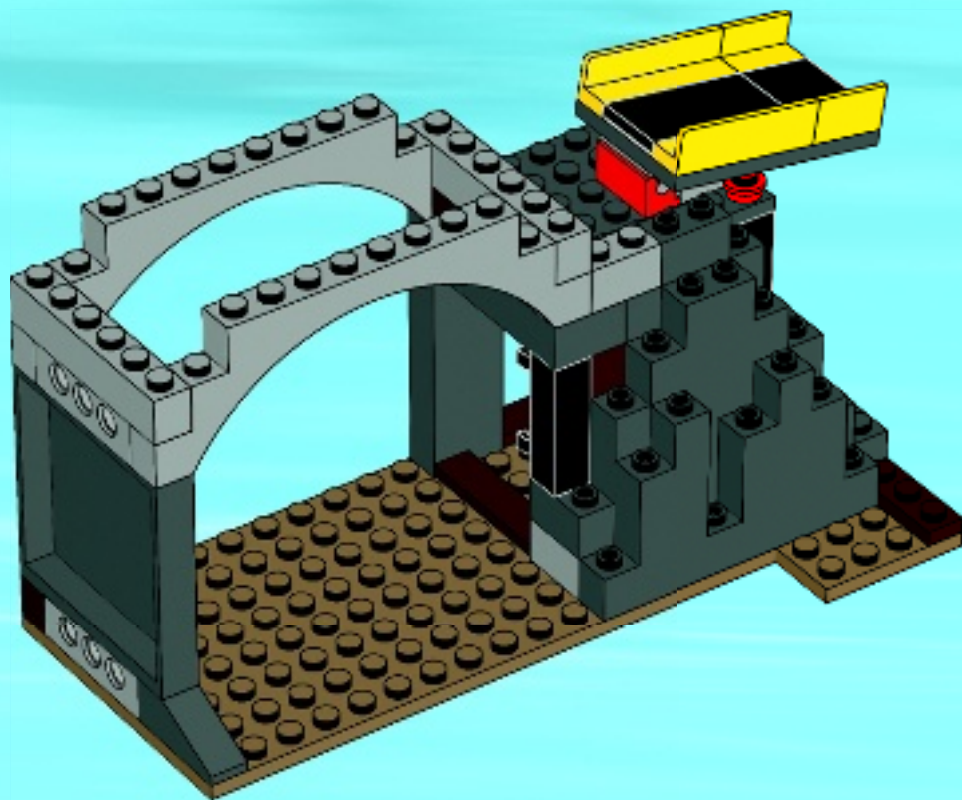



2x



2x

20

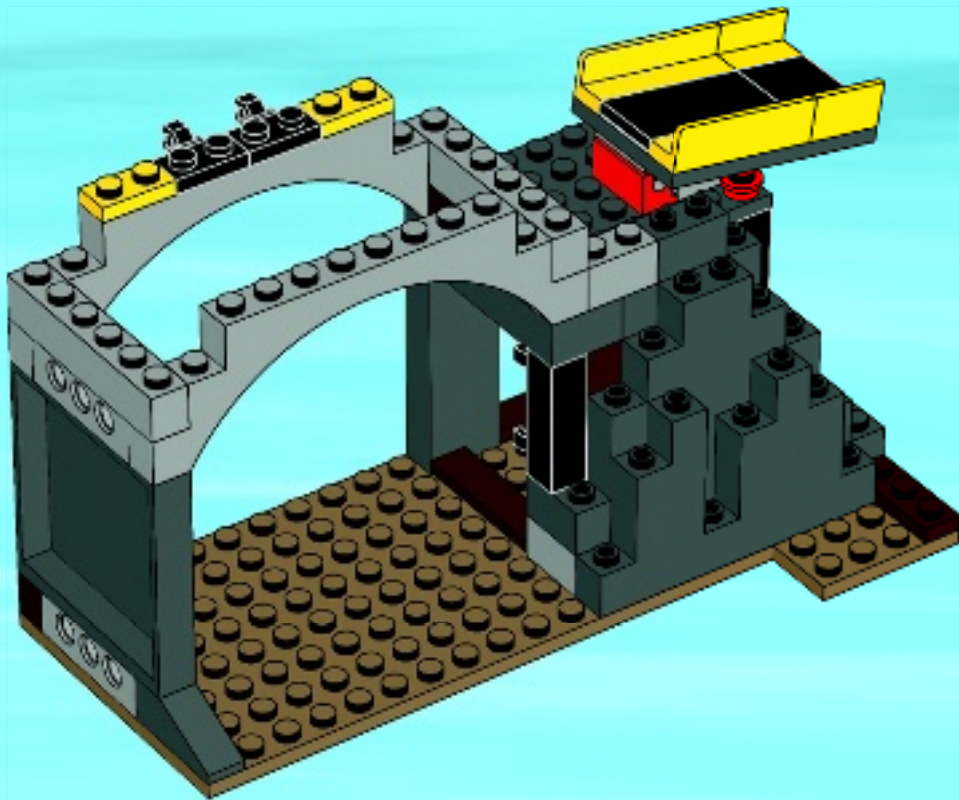



21

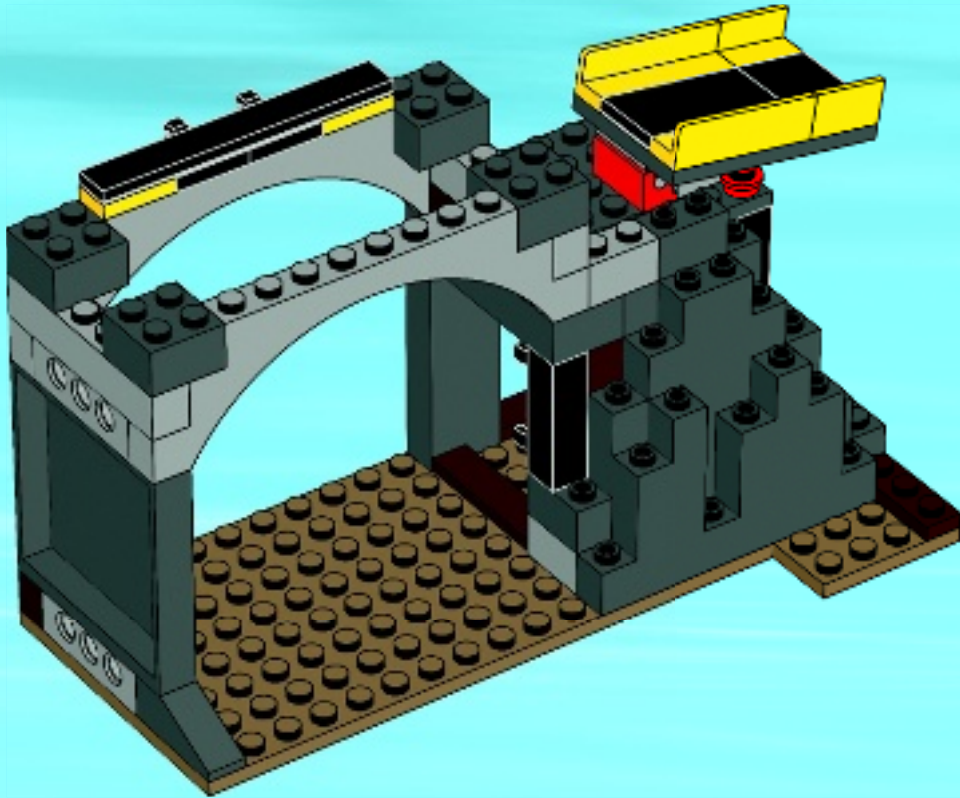

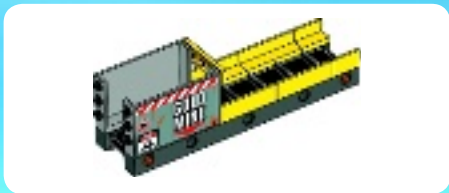

1

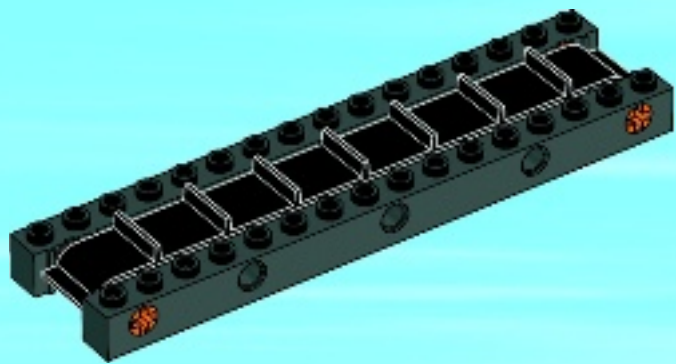

2

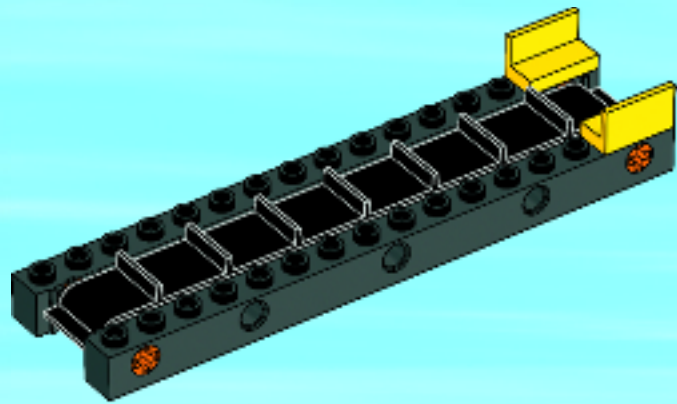



4x

3

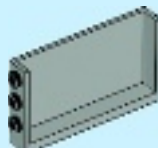
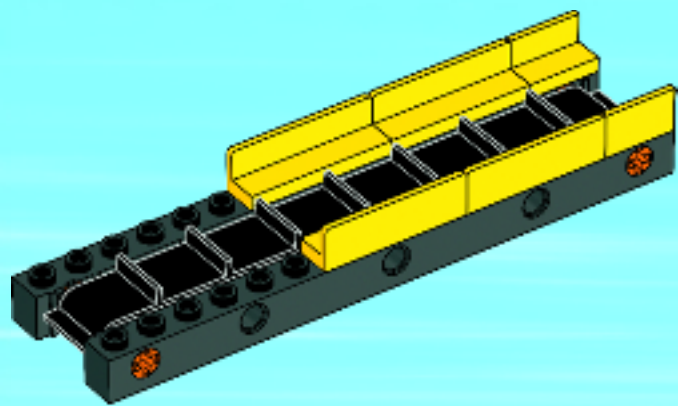

1x

4

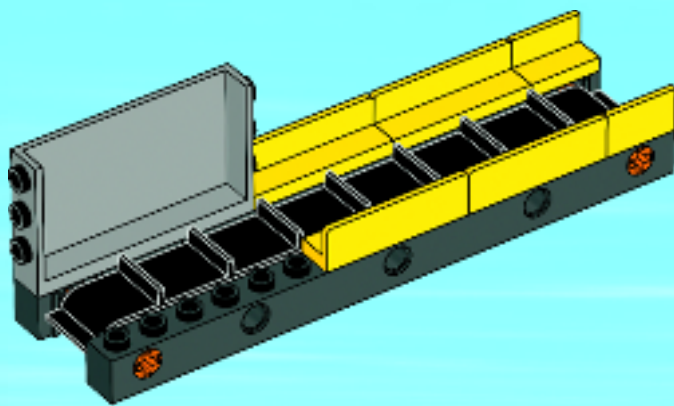

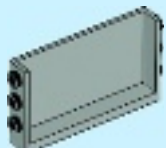

1x

5

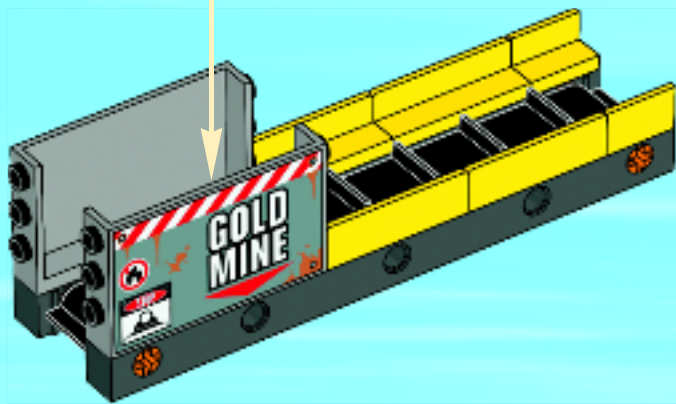
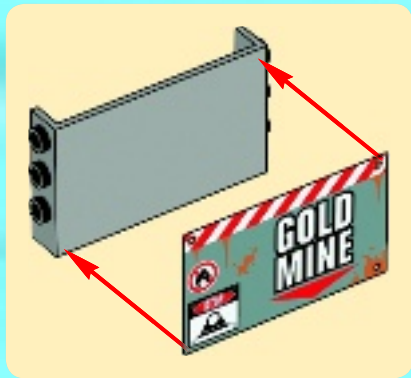

1x

6

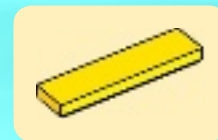

22

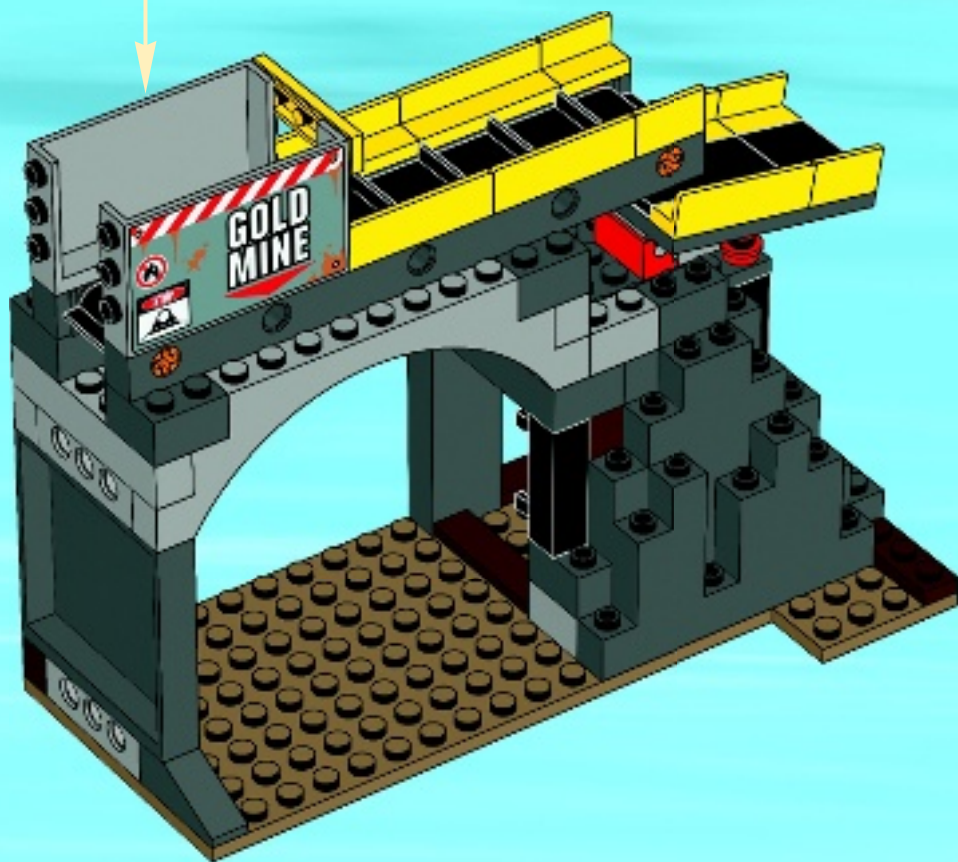

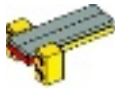

2x



1x



1x



2x

23

1

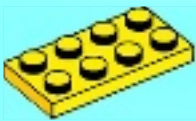

2

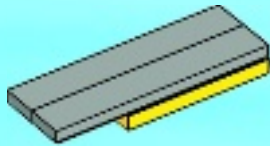

3

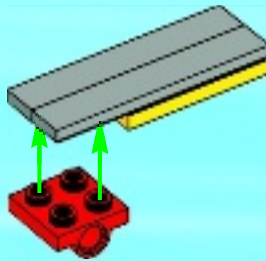

4

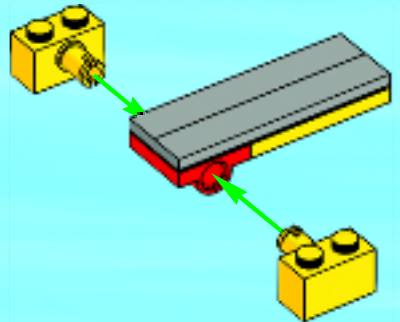

5

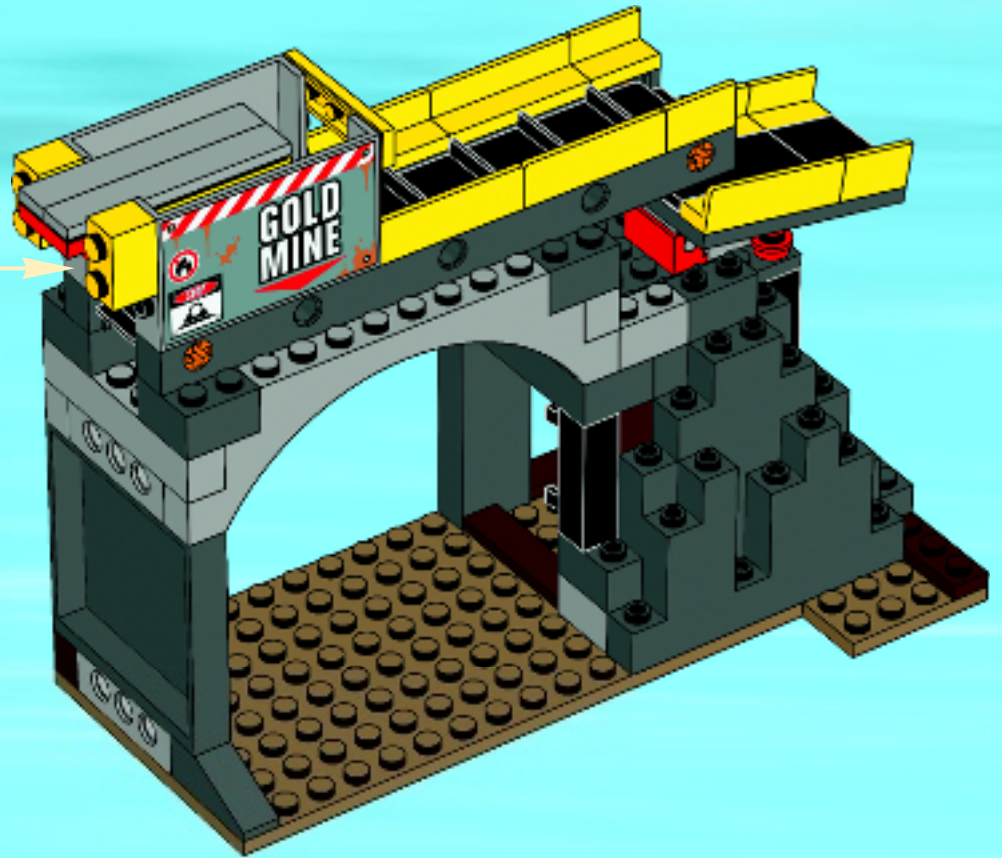
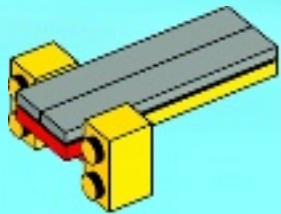



2x

24

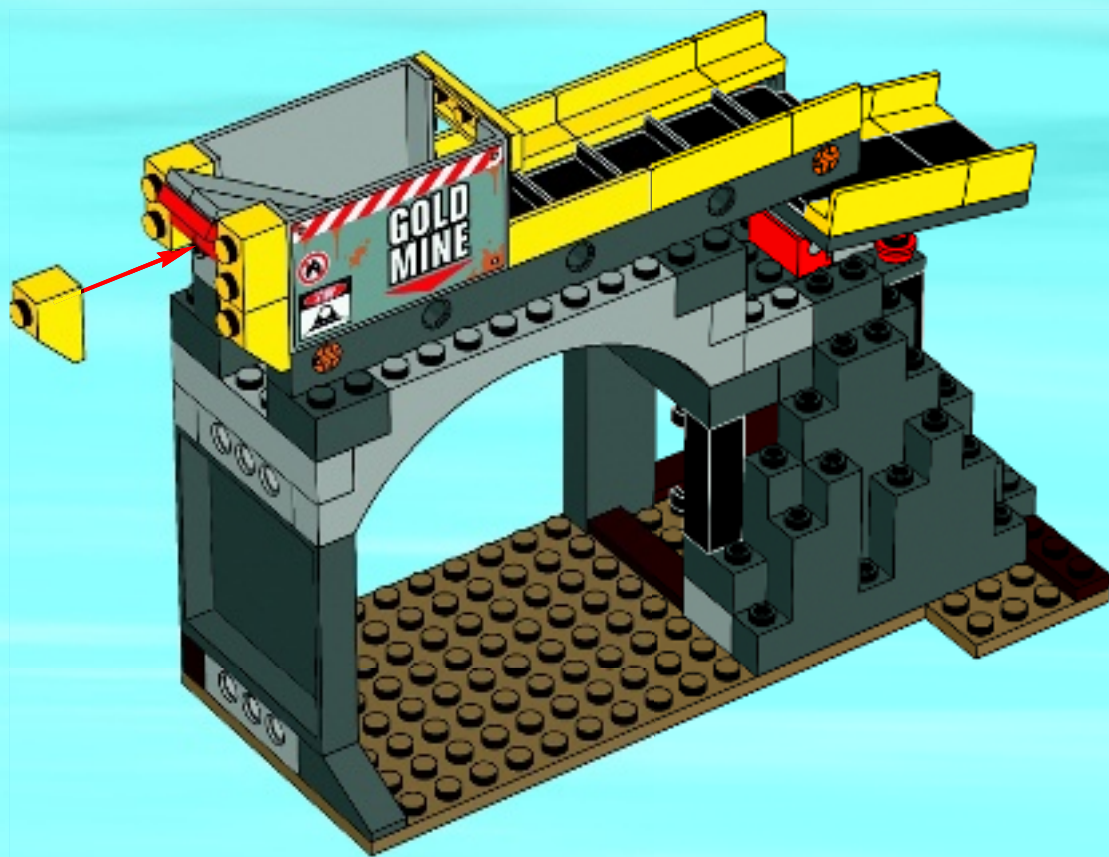



1x



1x

25

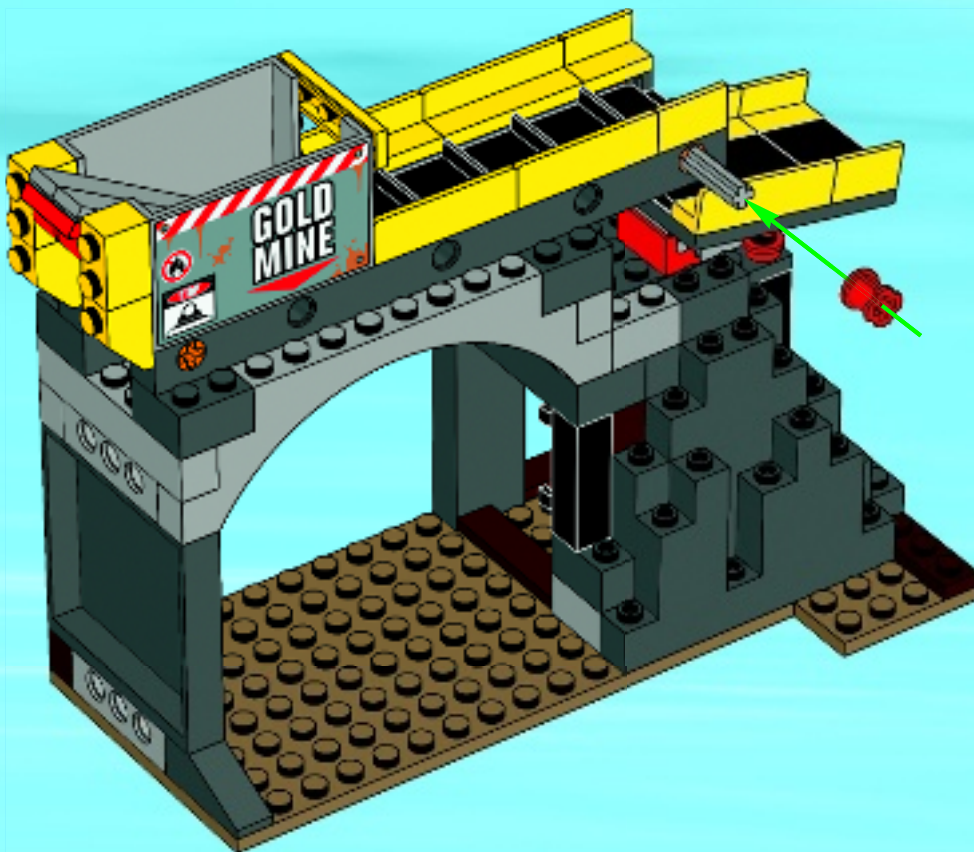



1x



1x

26

1



2



3

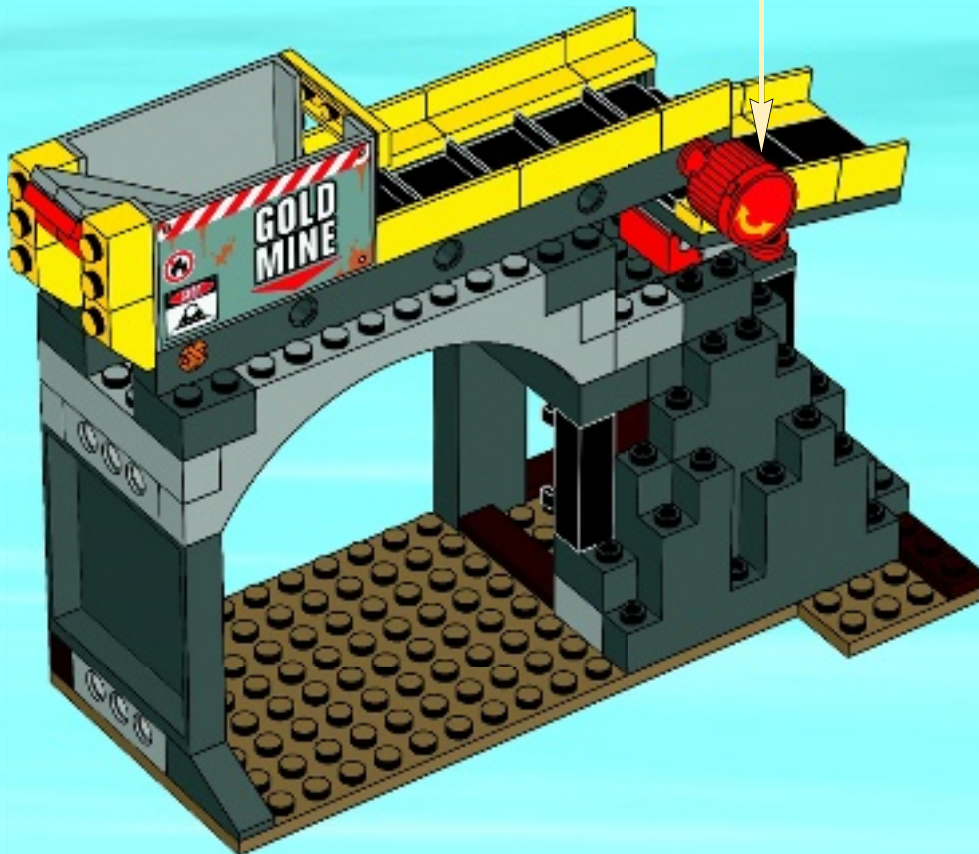

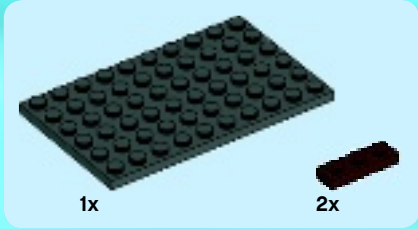

1

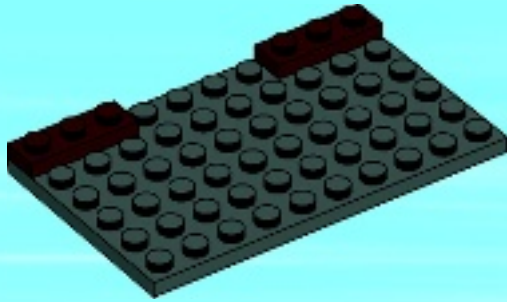

2

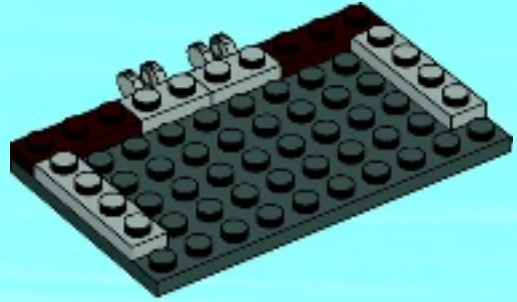

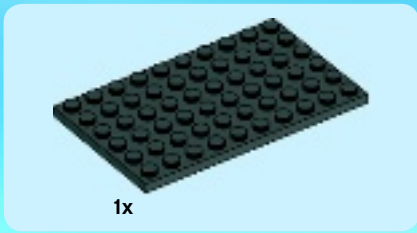

3

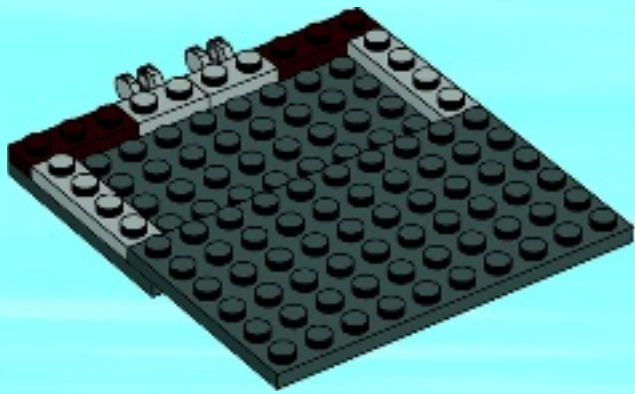

4

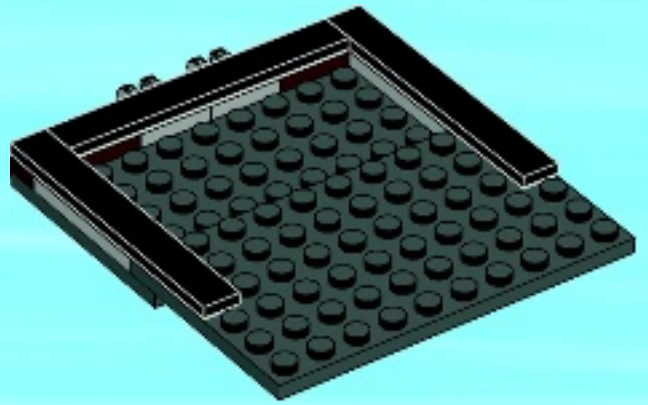



2x

5

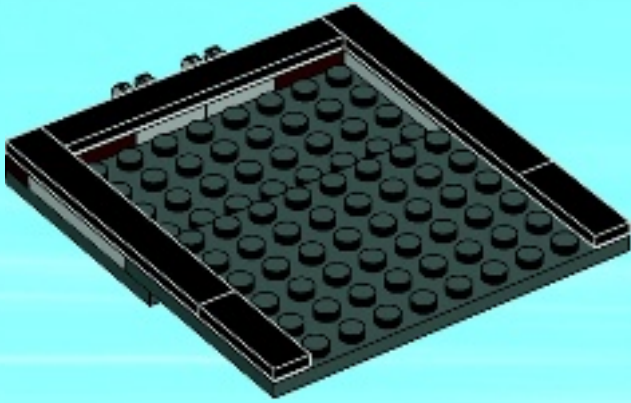

6x

6

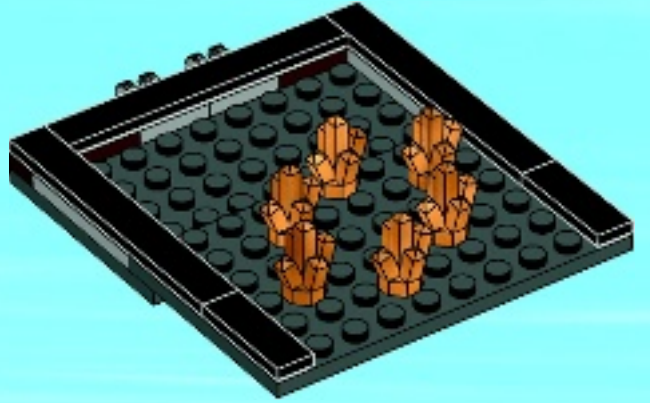



27

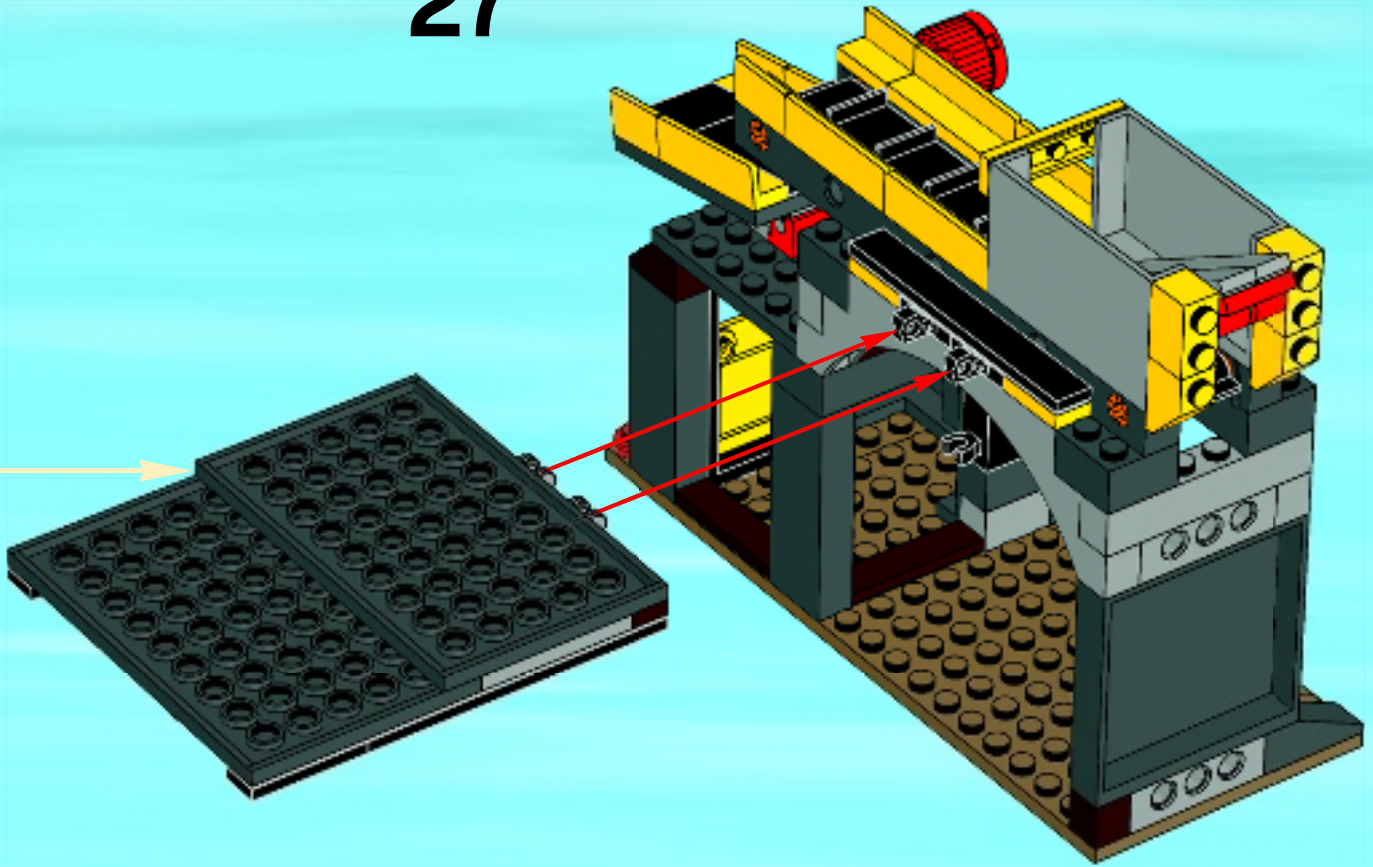

28

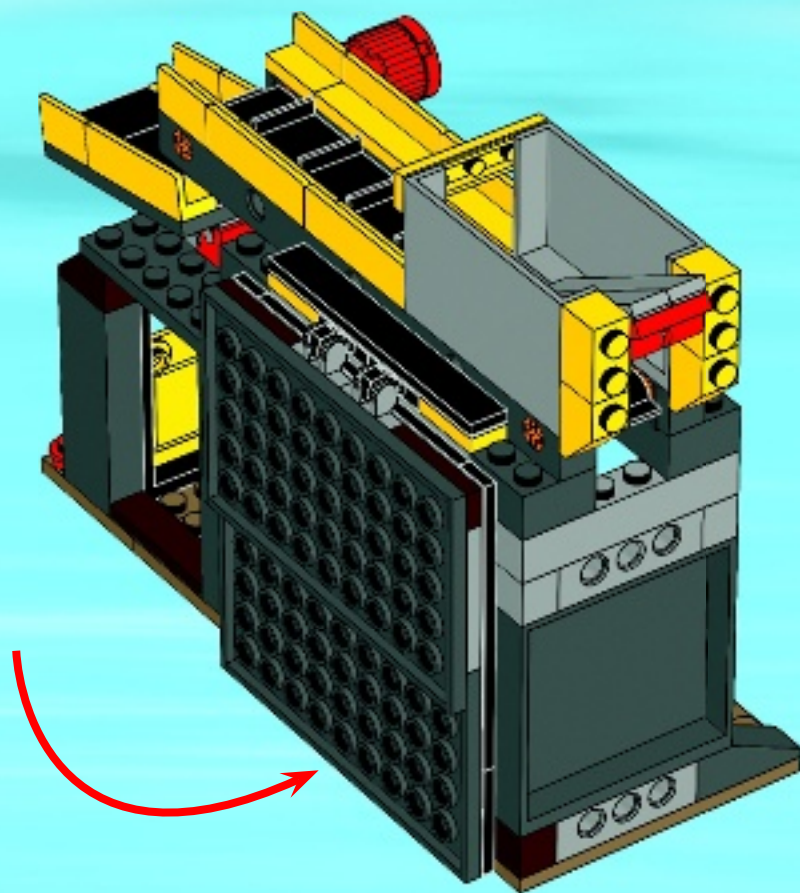



2x

29

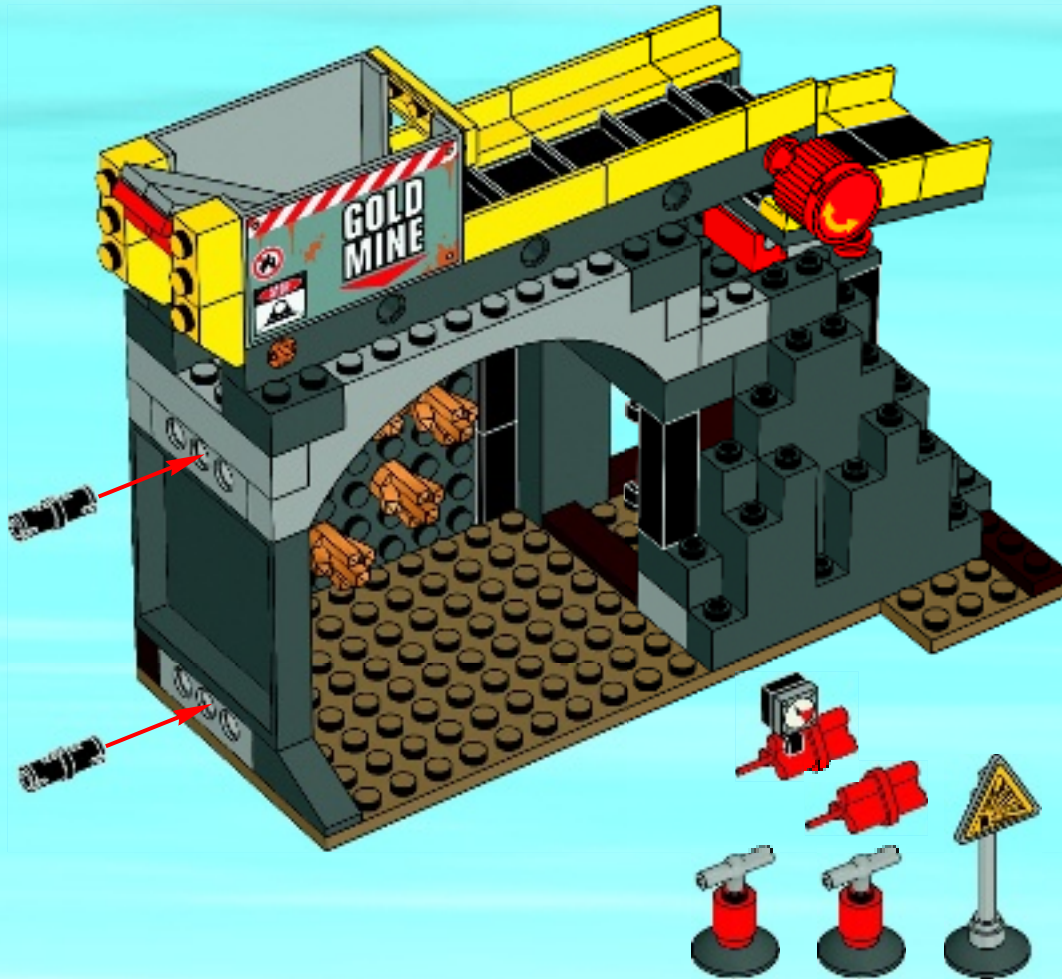



CITY



7279



7285



7286



7287



7288



7498