

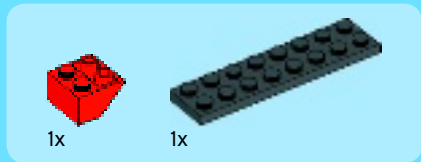

# CREATOR

31024

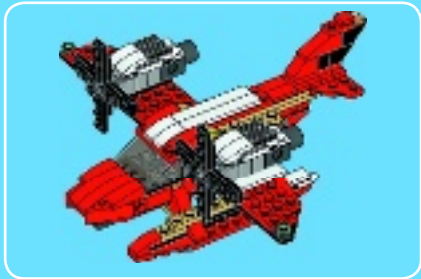



1

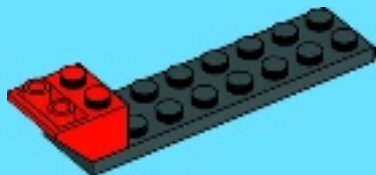

2



2

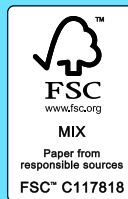



1x

3

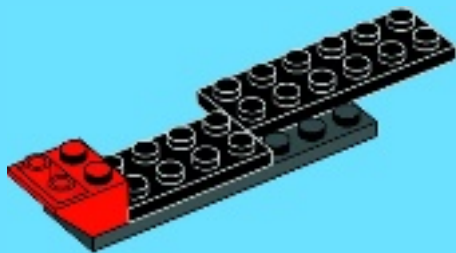

1x

4

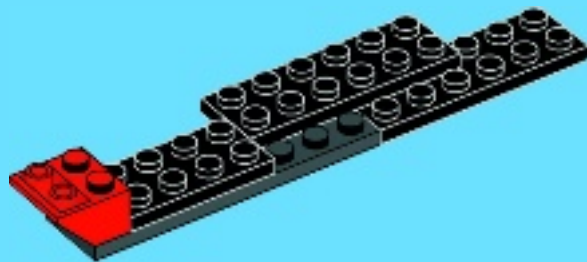



1x



1x

5

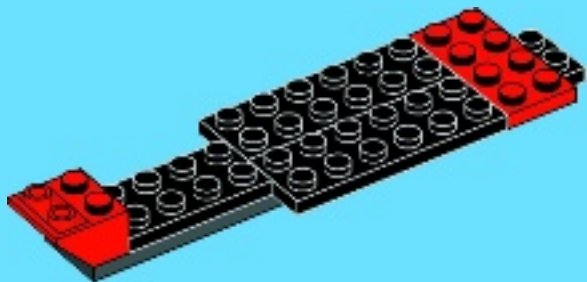

1x



1x

6

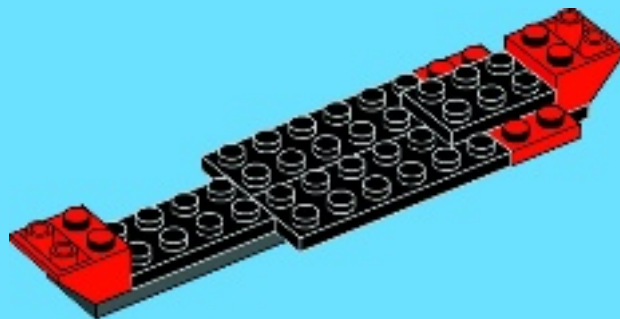



4x

7

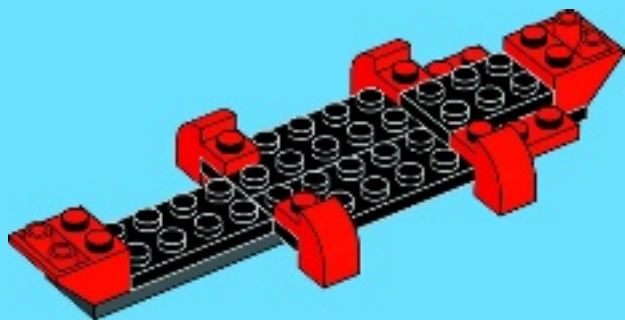

2x



1x



2x

8

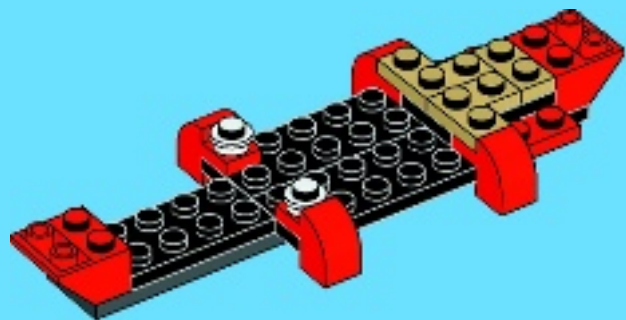



2x



2x

# 9

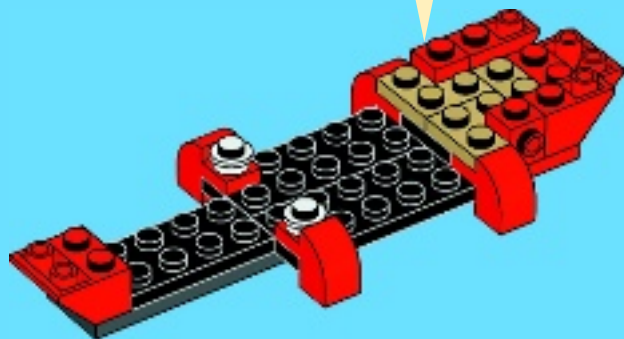

2x



2x

# 10

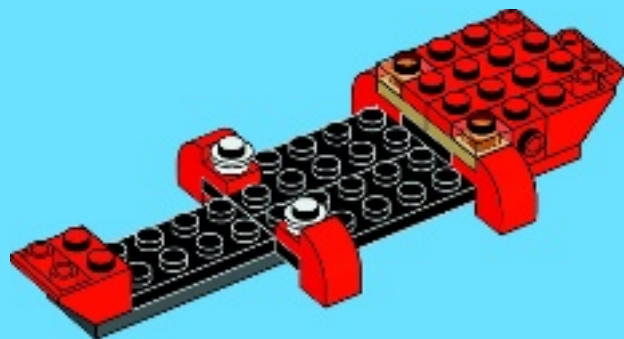



2x



2x



2x



2x

# 11

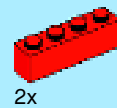
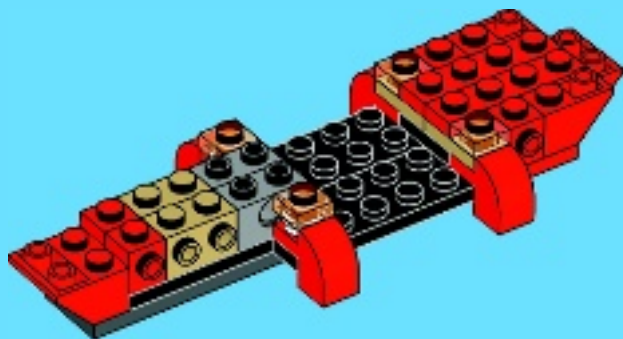

2x

# 12

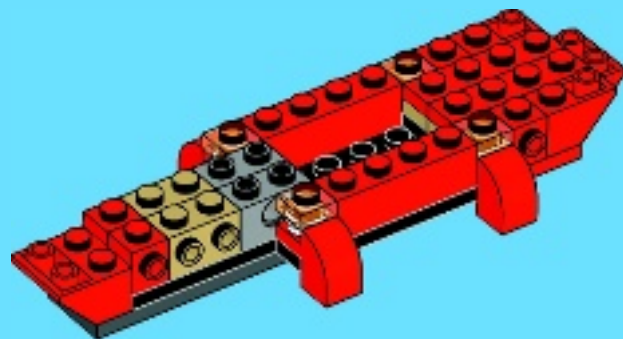



2x



2x



4x

# 13

1

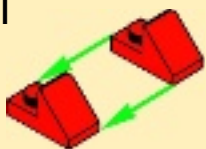

2



3

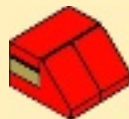

2x

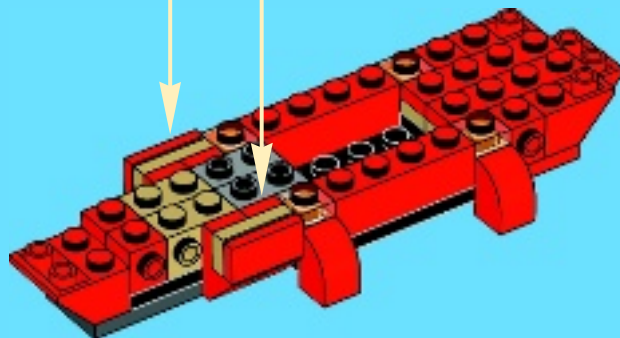





2x



1x



2x

# 14

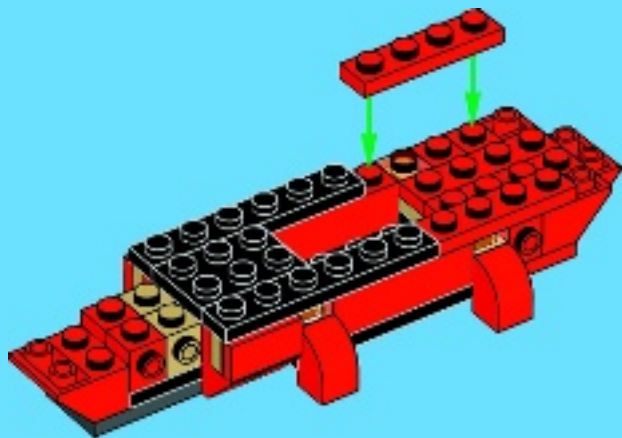

1x

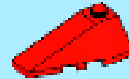

1x

# 15

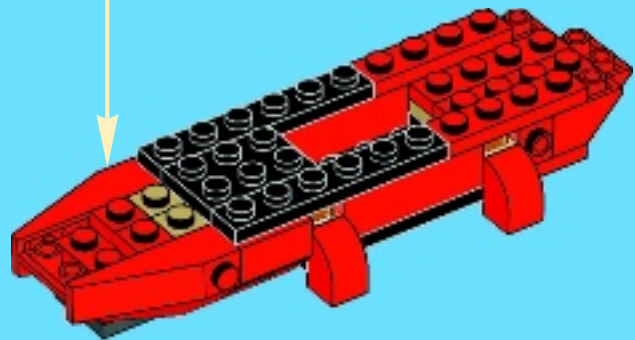



1x



1x



2x

# 16

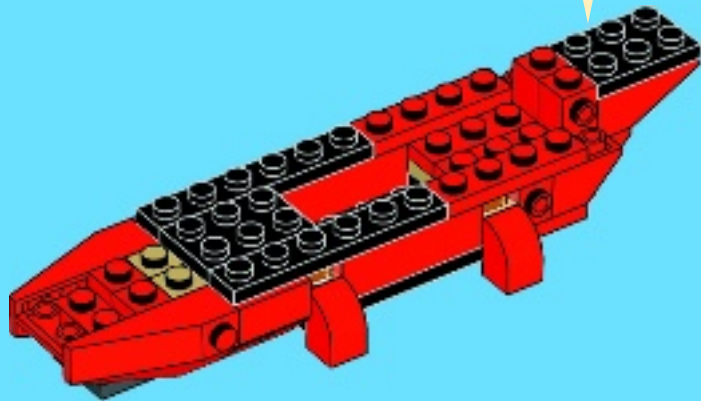

2x

# 17

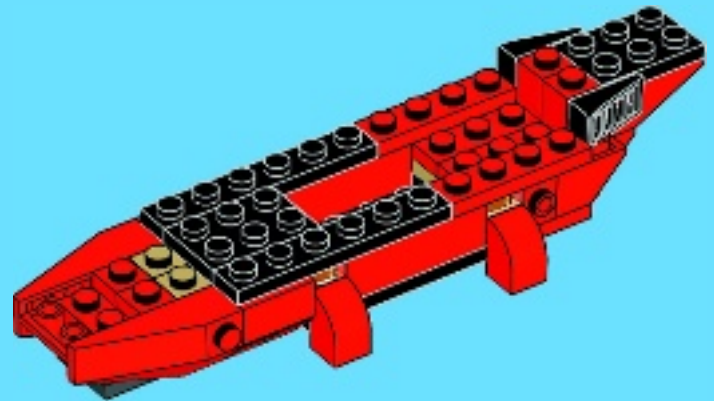



2x



1x



1x

# 18

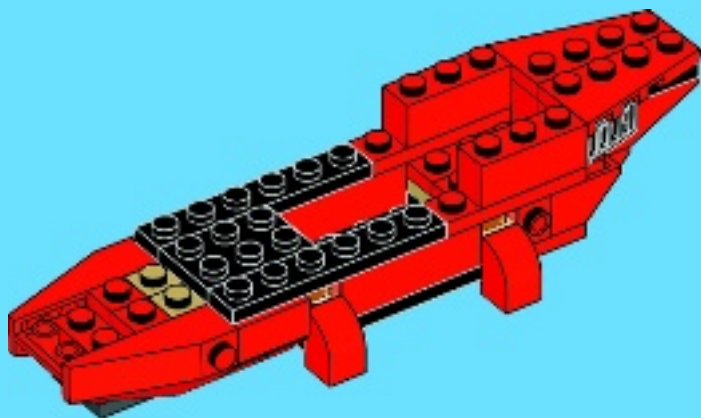

2x

# 19

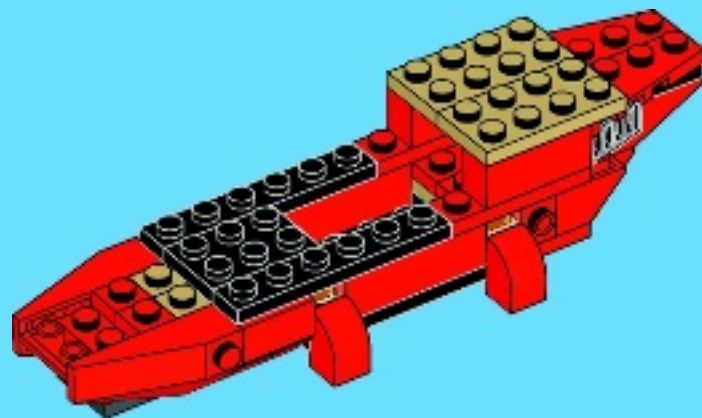



4x



2x



2x

# 20

1

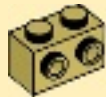

2

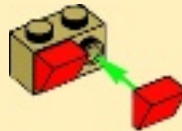

2x

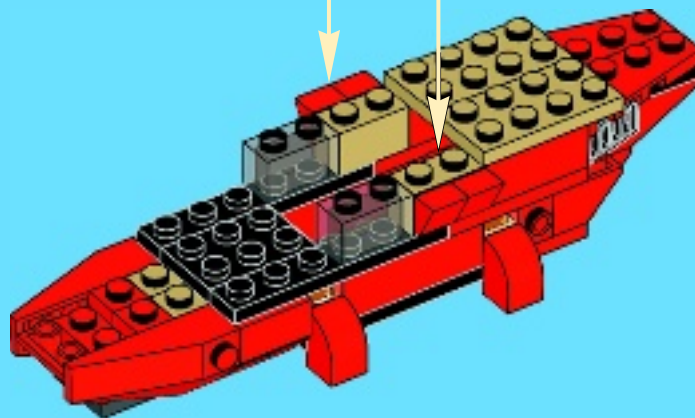



1x

21

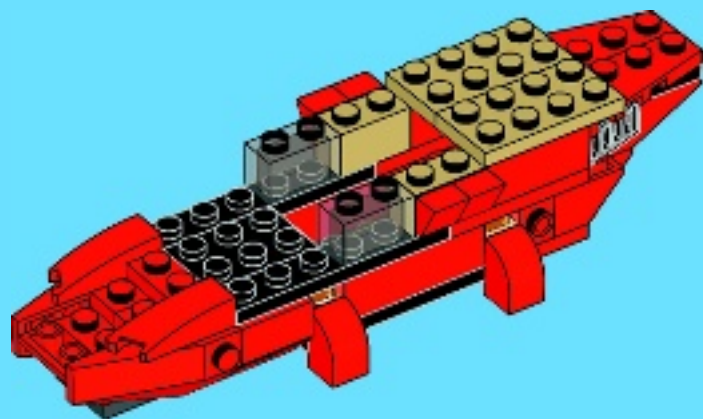



2x

22

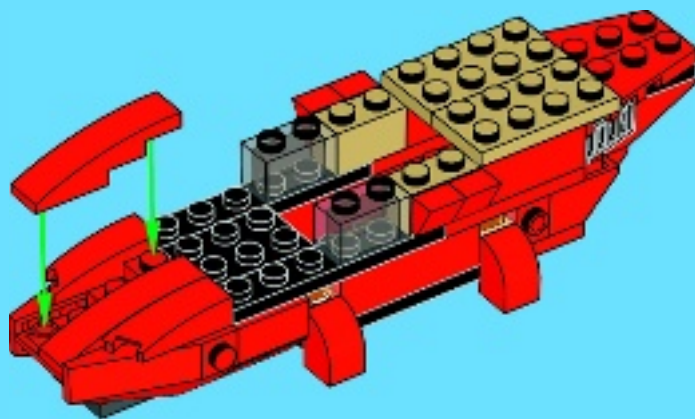



1x



1x

1



1x

2



1x

3

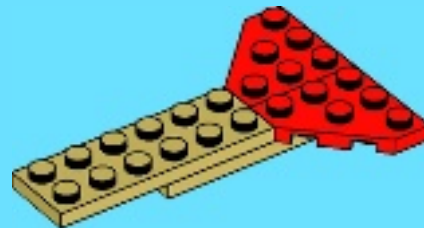



2x



4x

4

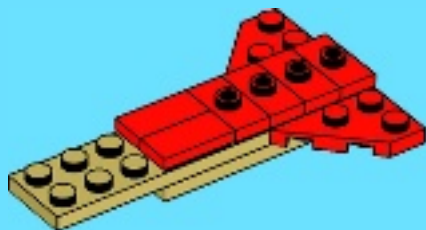

1x

5

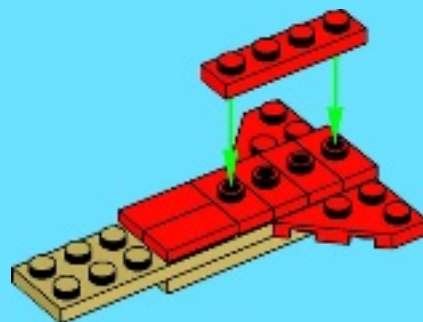

1x



1x



1x

6

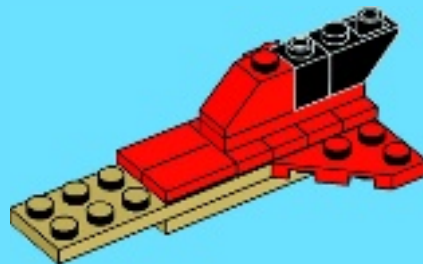





1x



1x

7

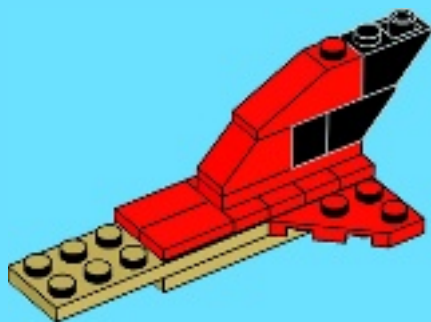

1x

8

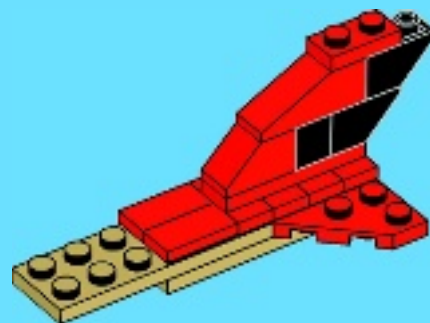

1x



1x

9

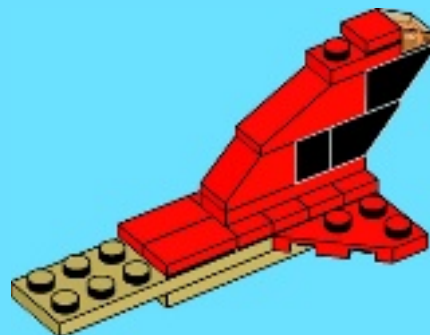

23

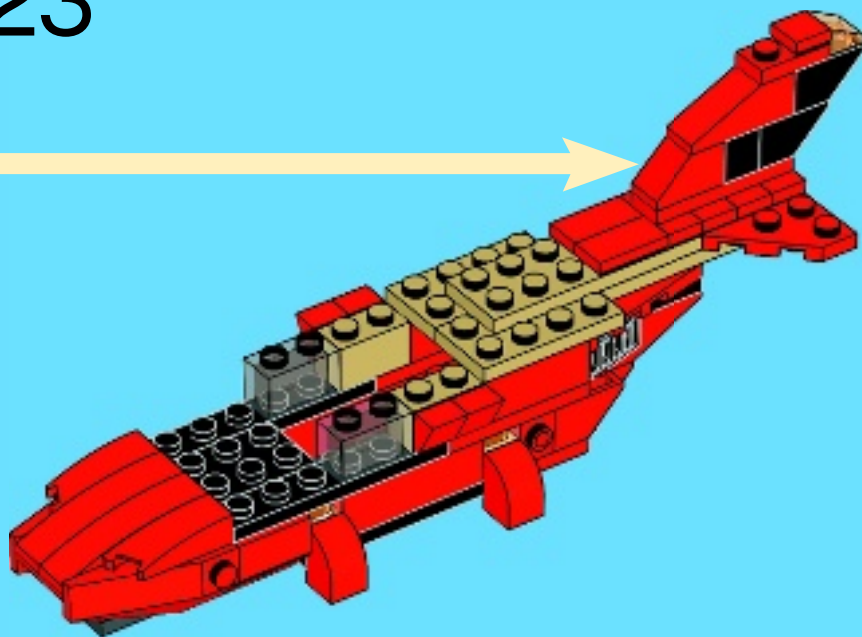

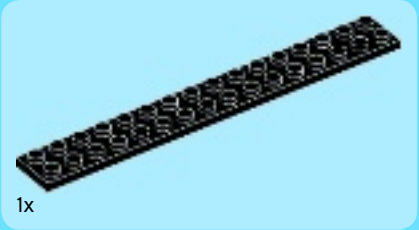
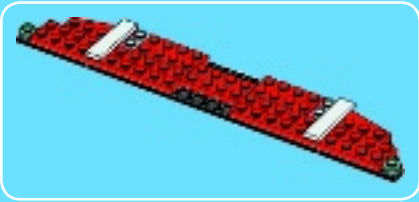

1x

1

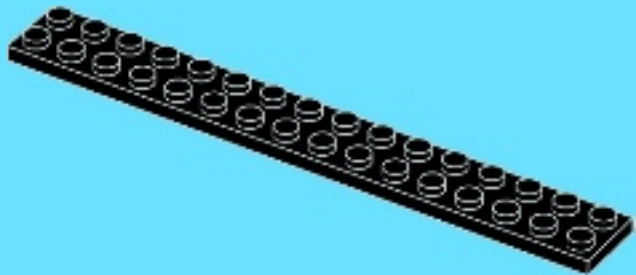

2

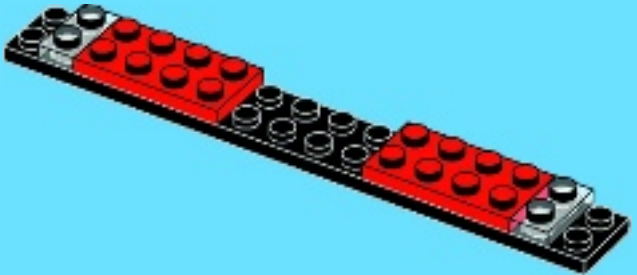



1x

3

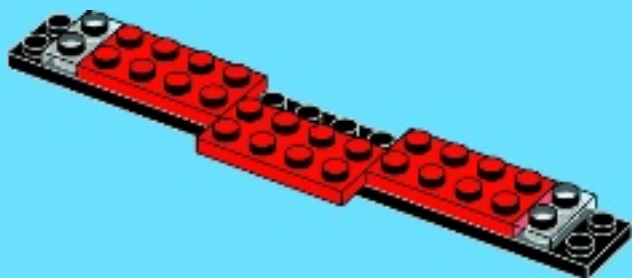

1x

4

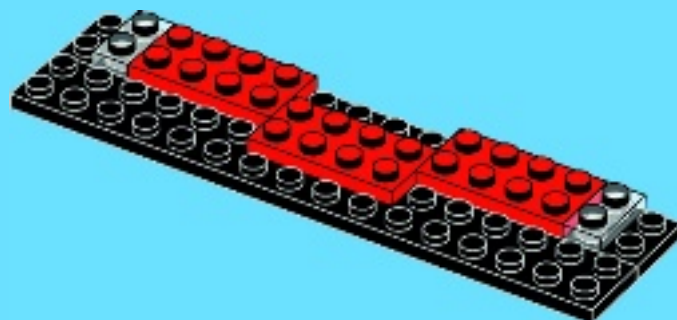



2x

5

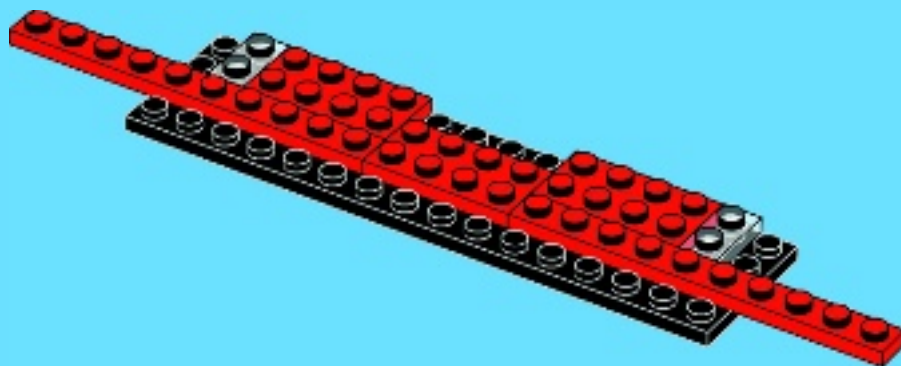



2x

6

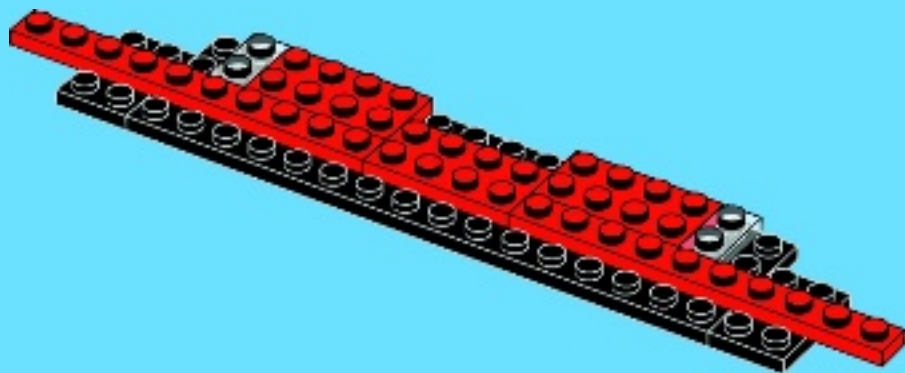



2x

7

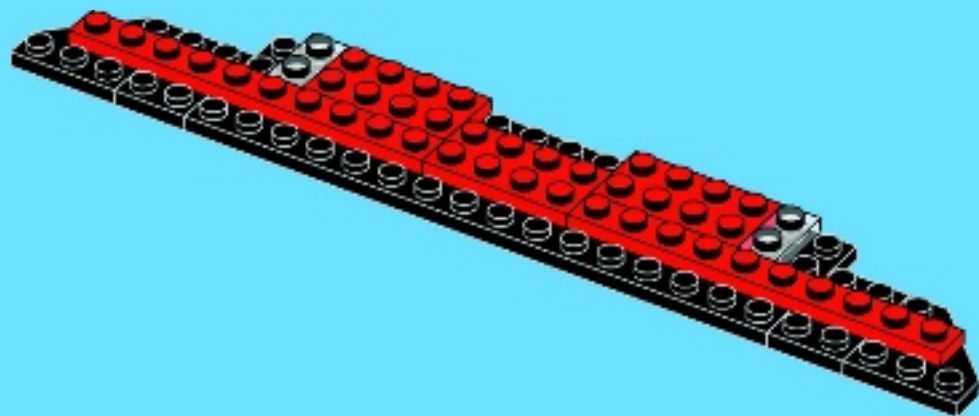



1x



1x

8

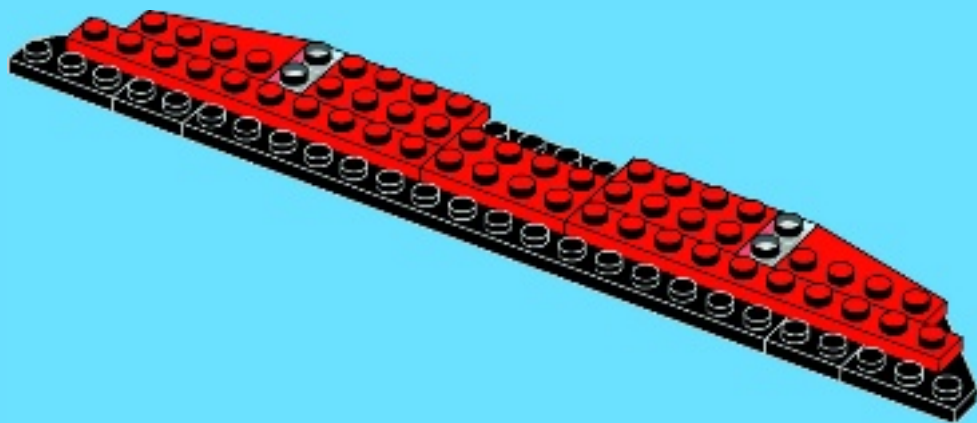





2x



2x

9

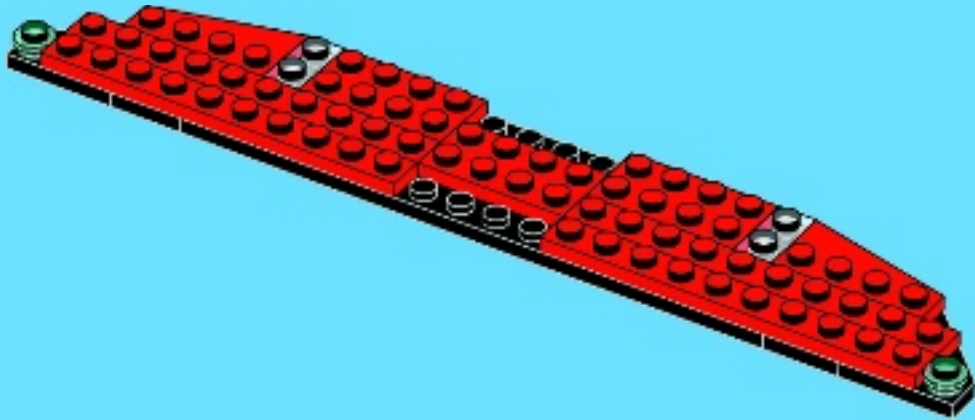



2x

10

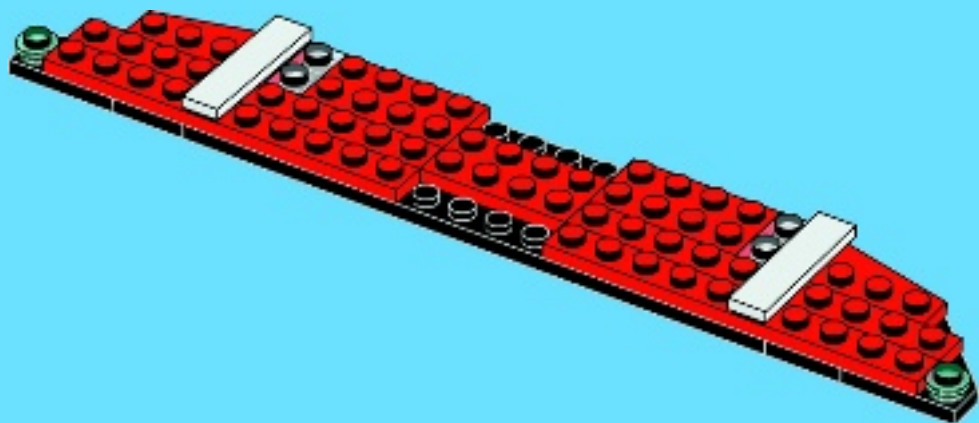

24

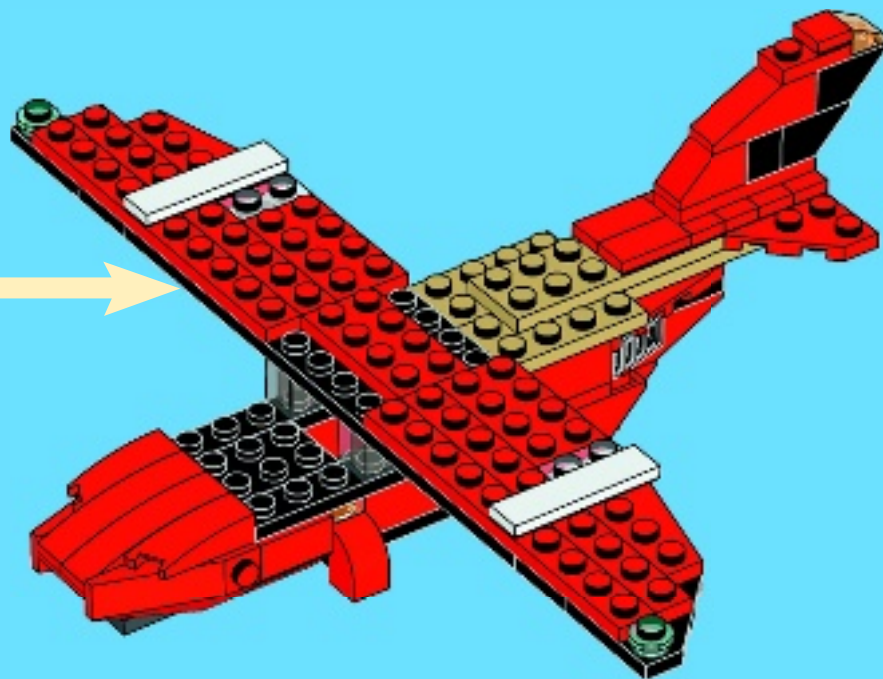

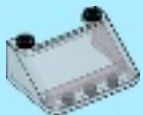

1x

25

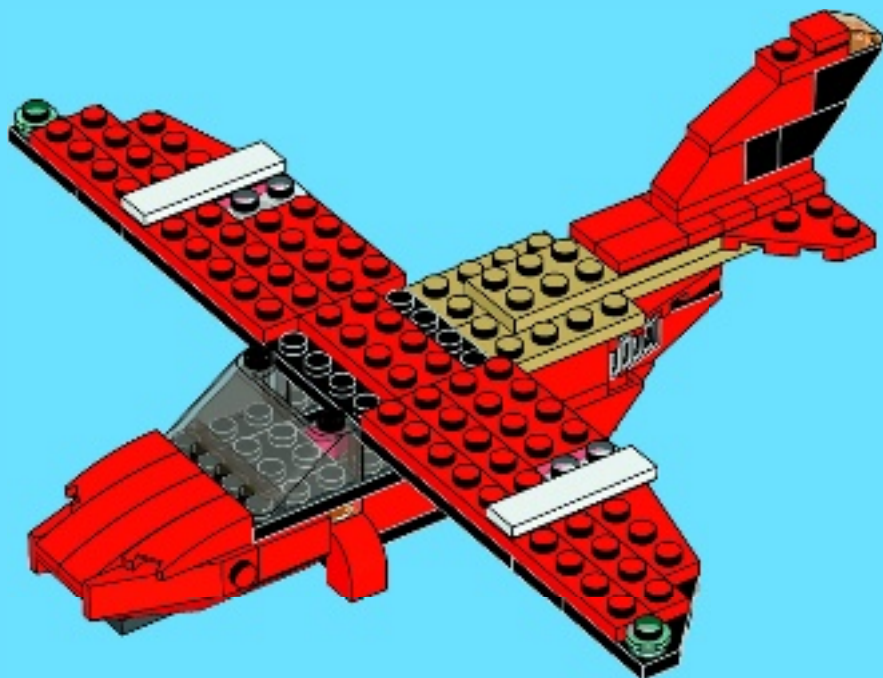



1x



2x

# 26

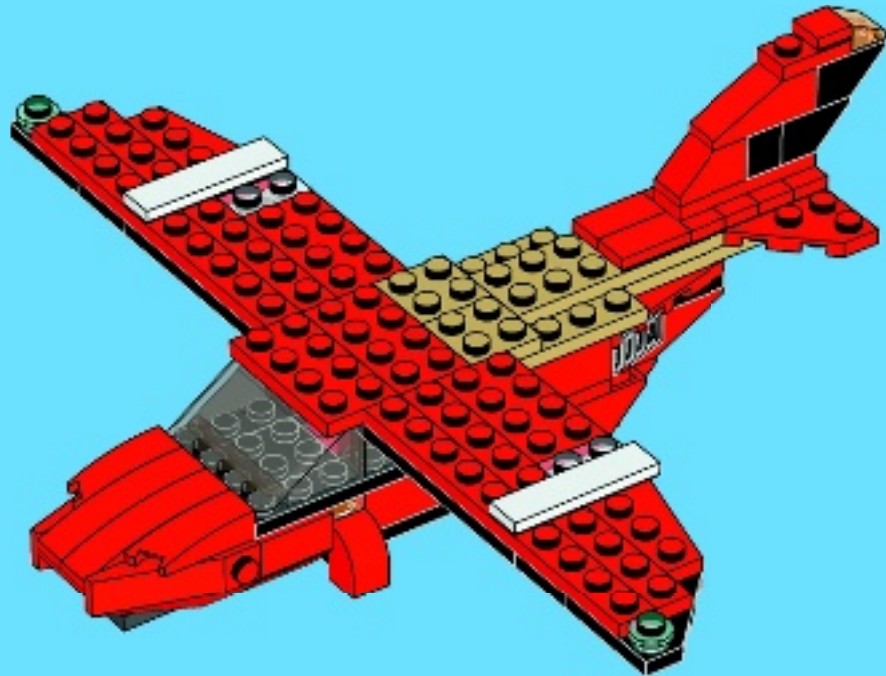



1x



2x

# 27

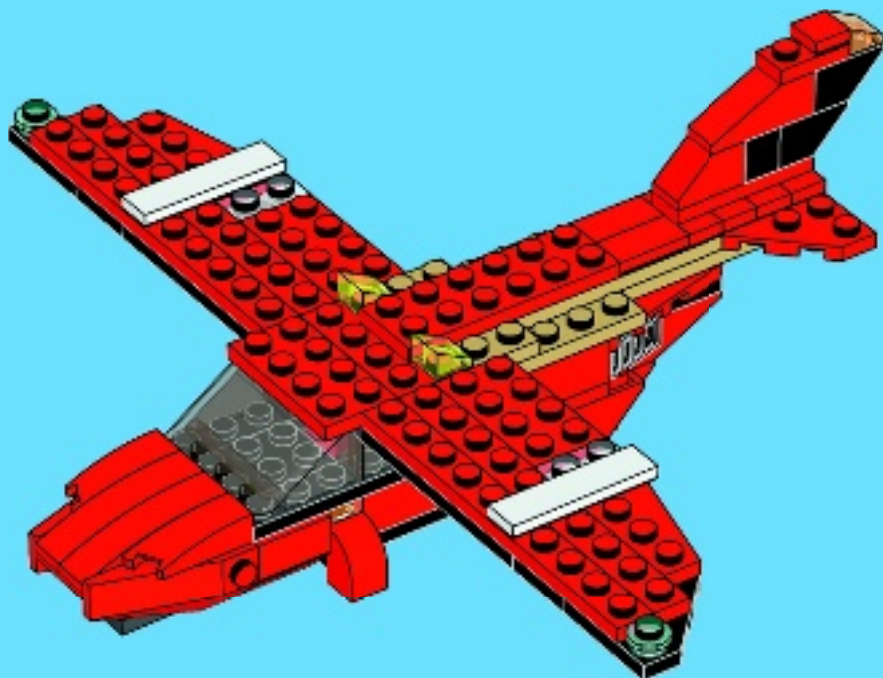



1x



1x

# 28

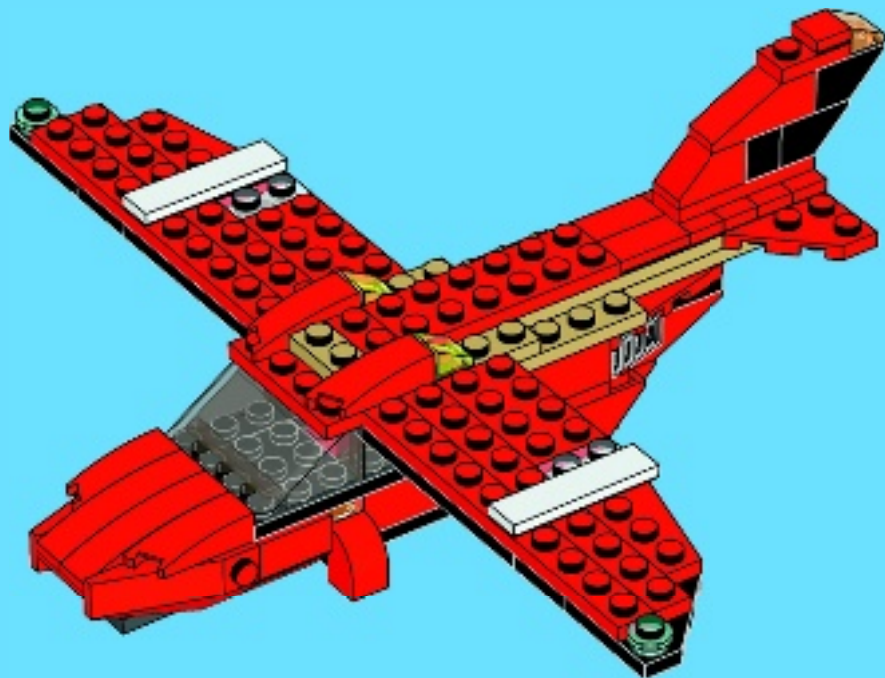



2x



2x

# 29

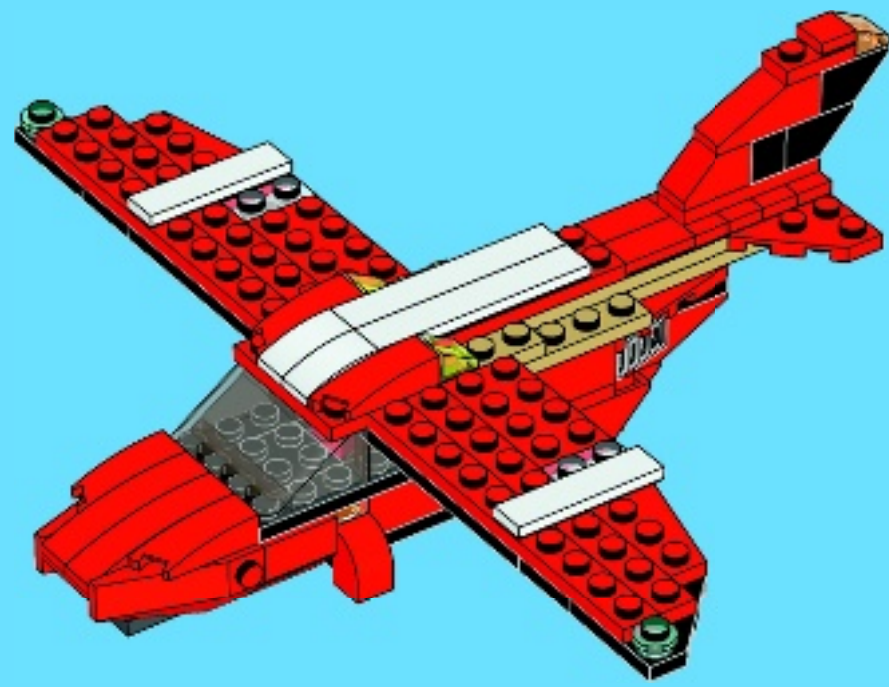





2x



1x



1x

1



1x

2



1x

3

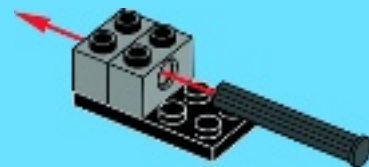

1x

4

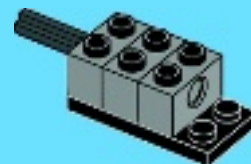



1x



1x

5

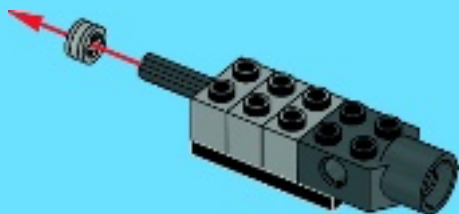

1x



2x

6





1x

7



2x



2x

8



2x



2x

9

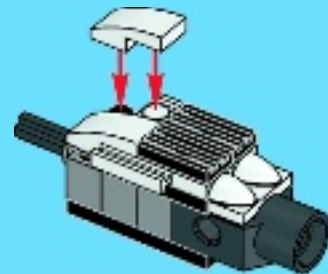

2x

30

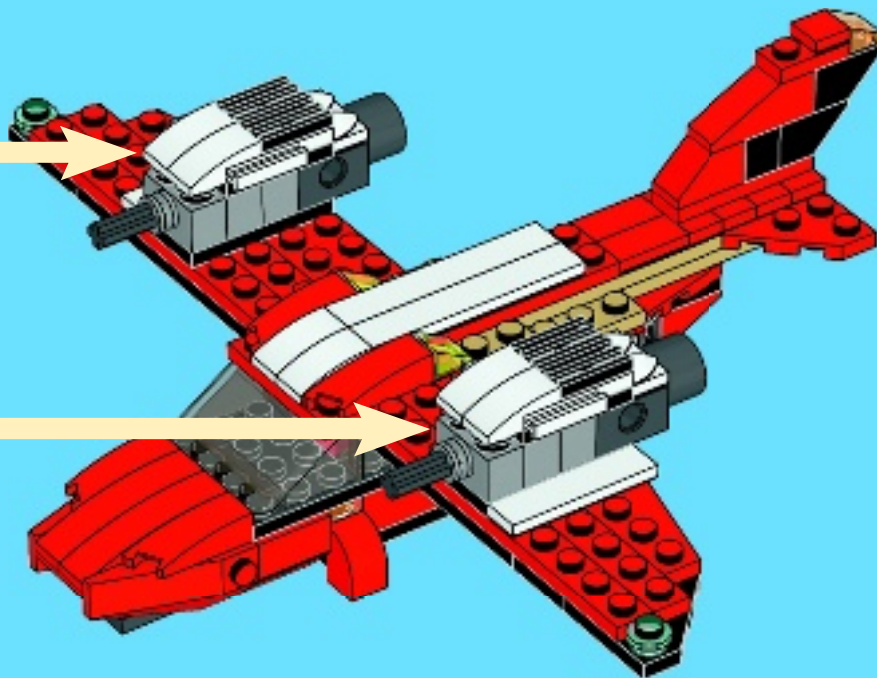

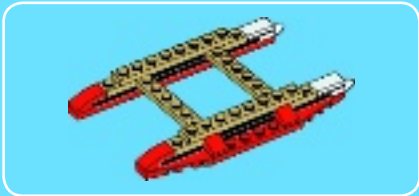

1x

1x

1

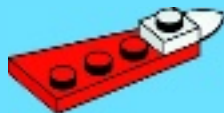

1x

2

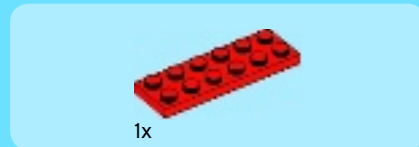

1x

3





1x

4

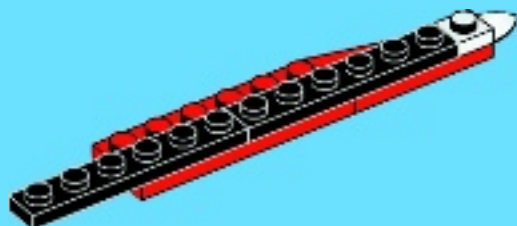

1x

5

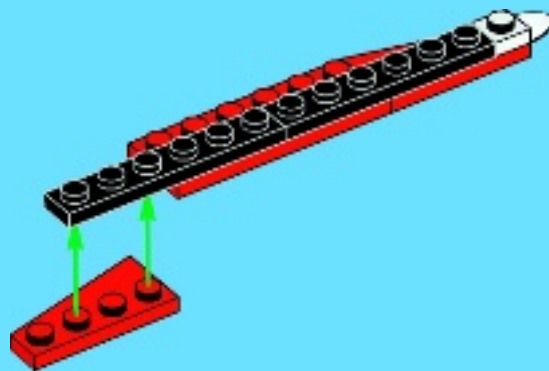

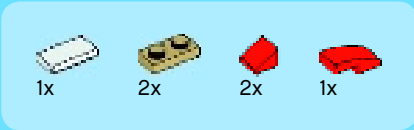

6

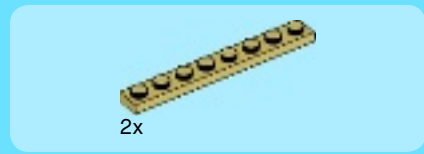
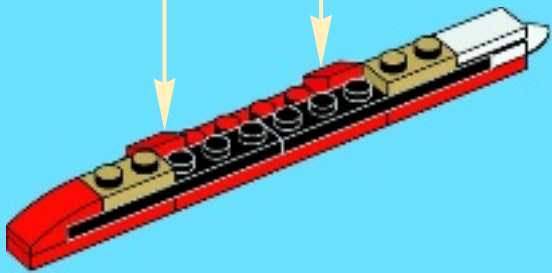
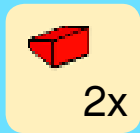

7

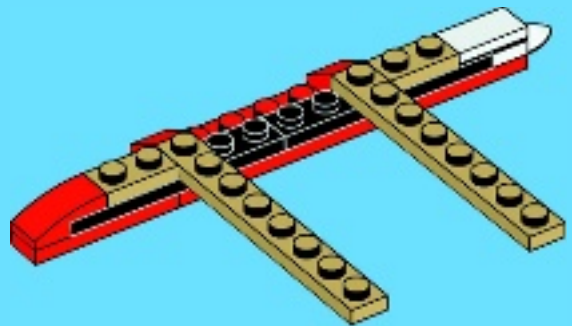

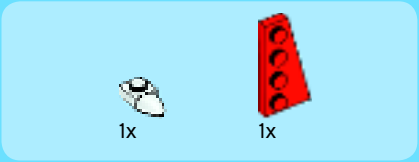
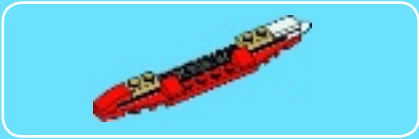

1

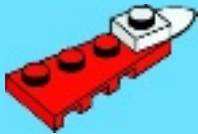

2

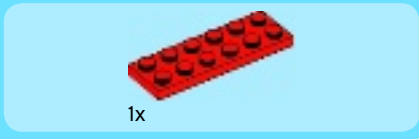

3

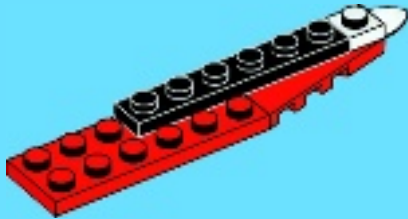

4

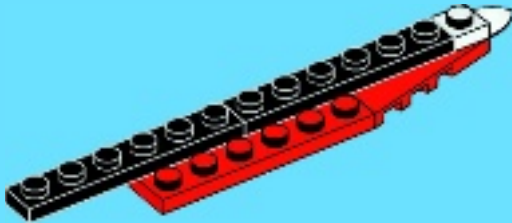





1x



1x



2x



2x



1x

5

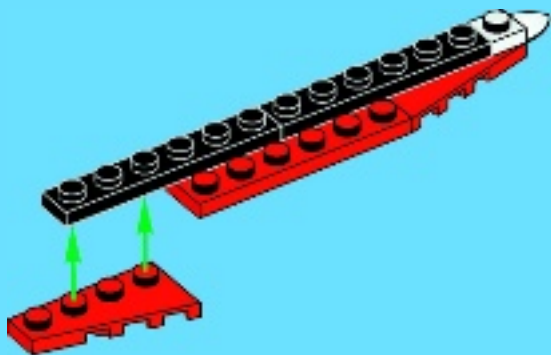

6

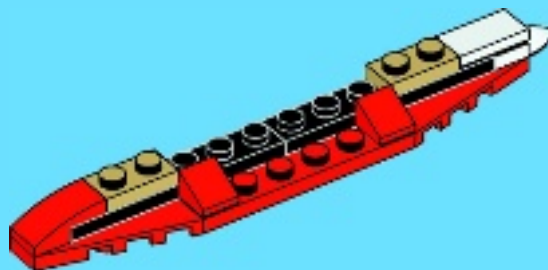

7

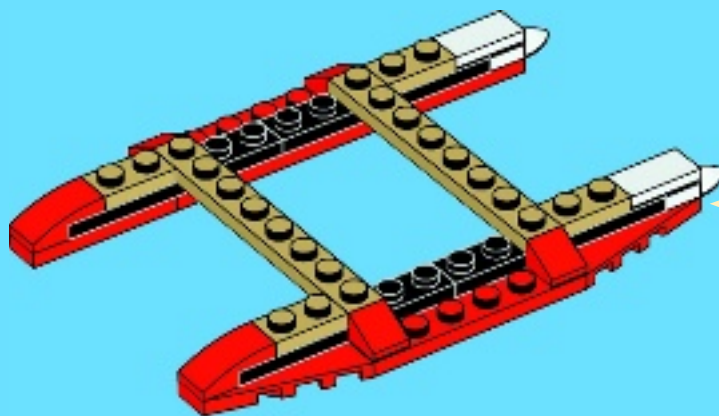



2x

8

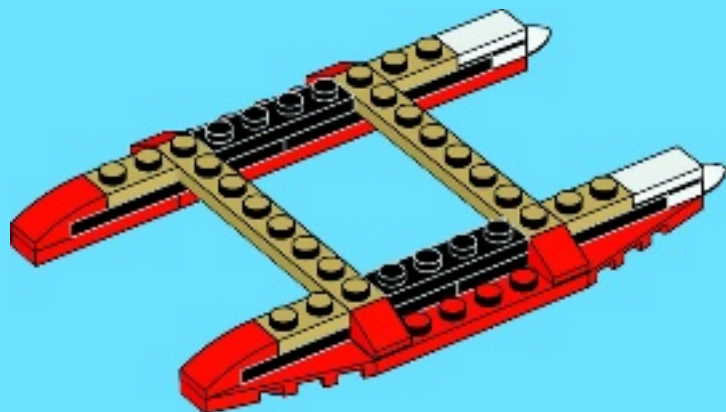



2x

9

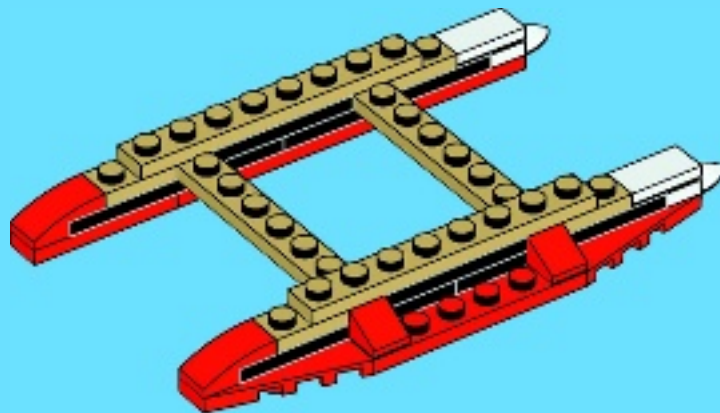



4x

10

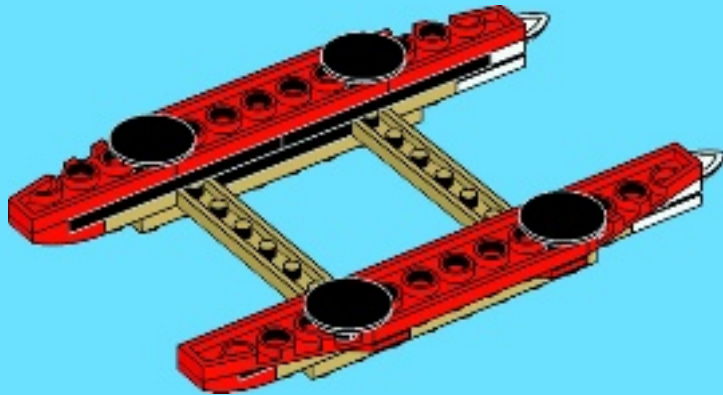

31

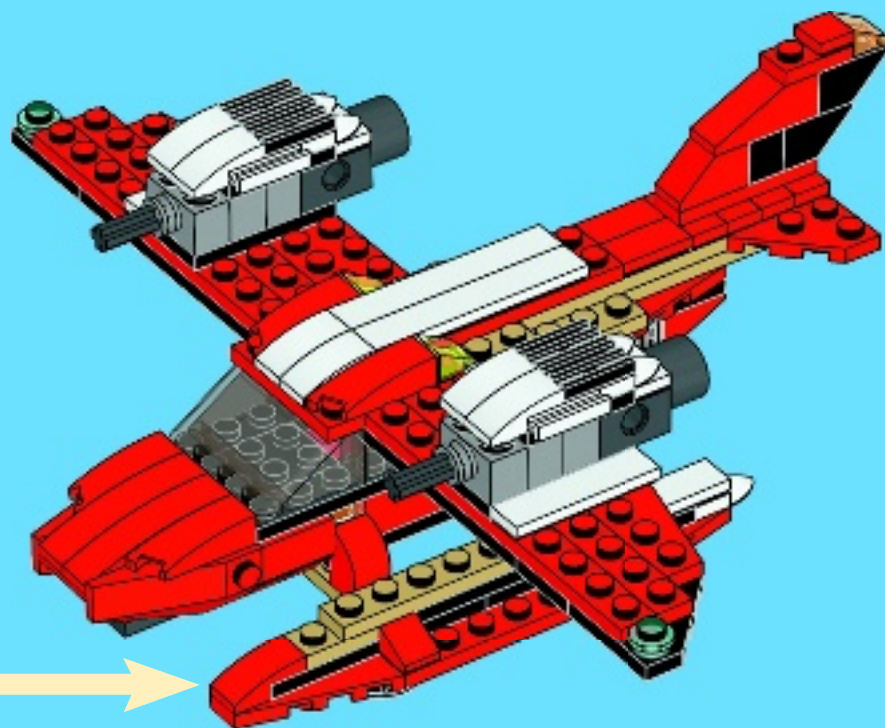



4x



2x

# 32

1



2



2x

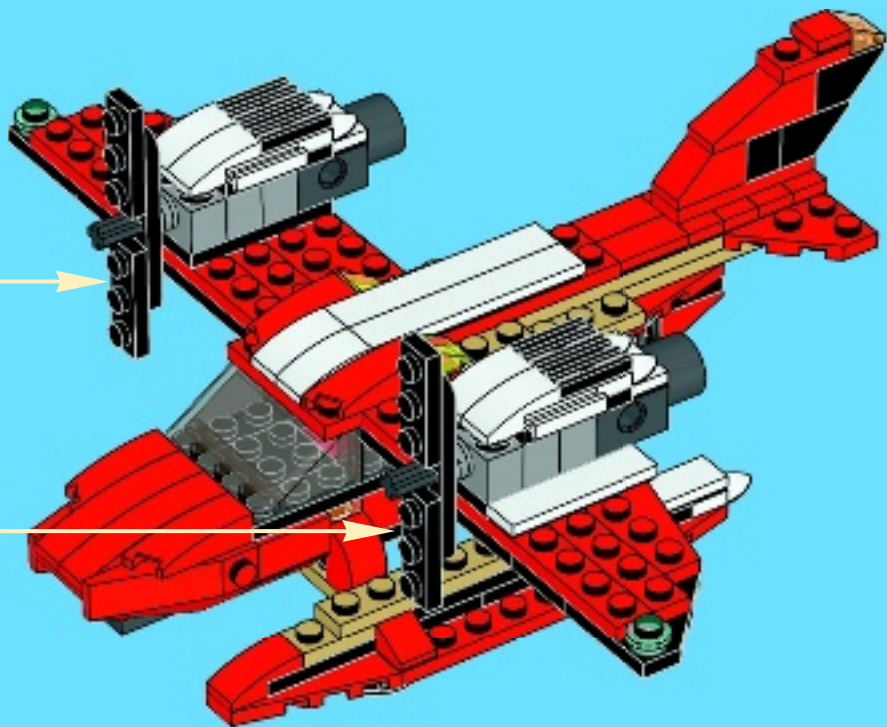



4x



2x

# 33

1



2

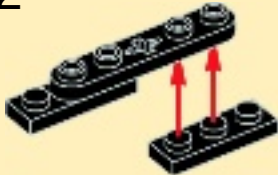

2x

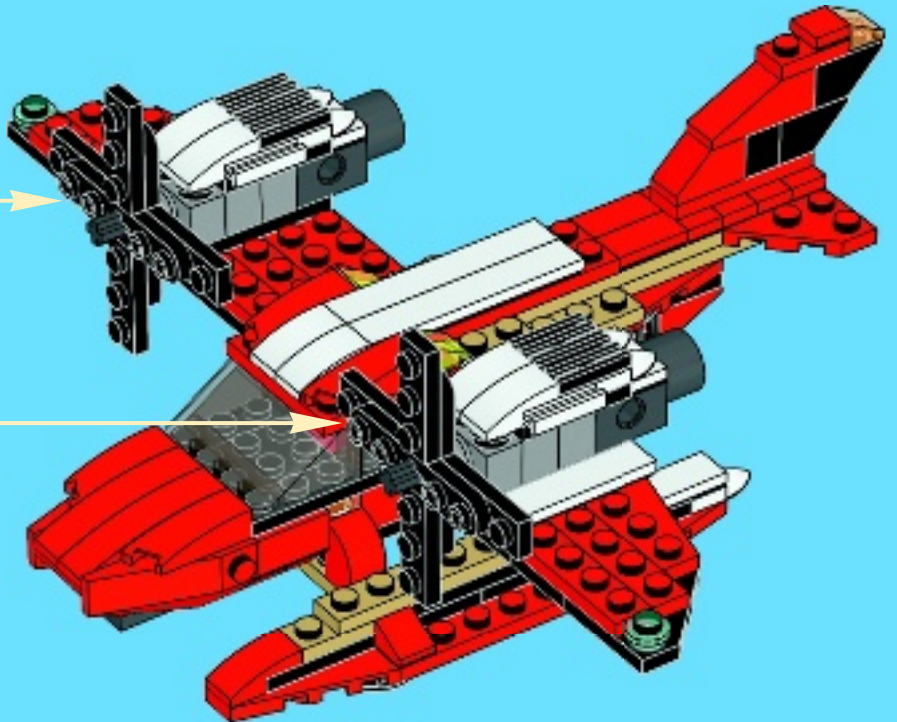





2x

# 34

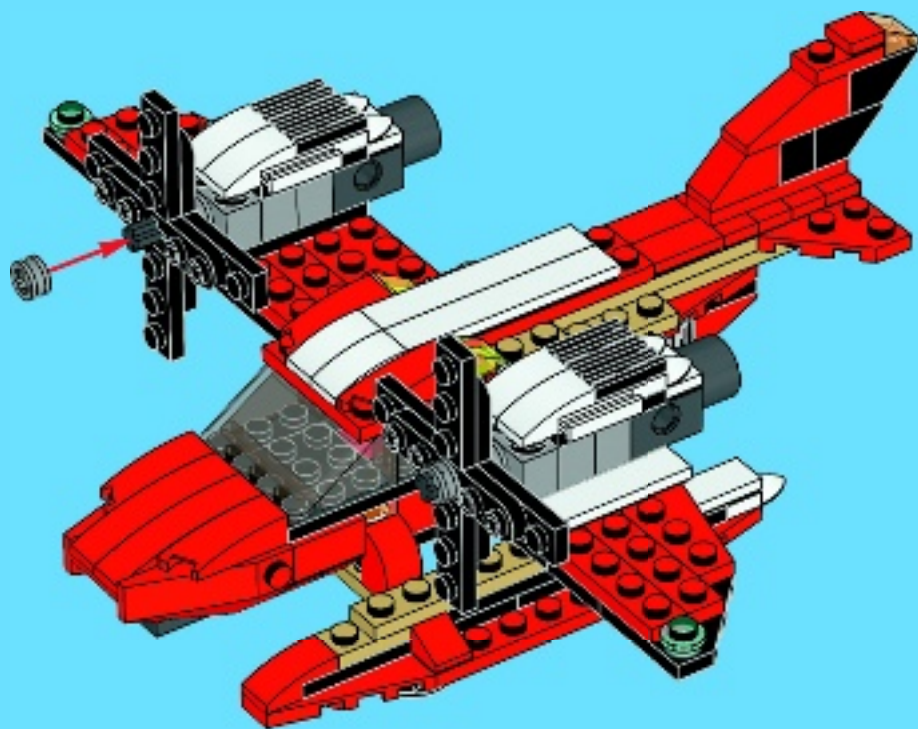



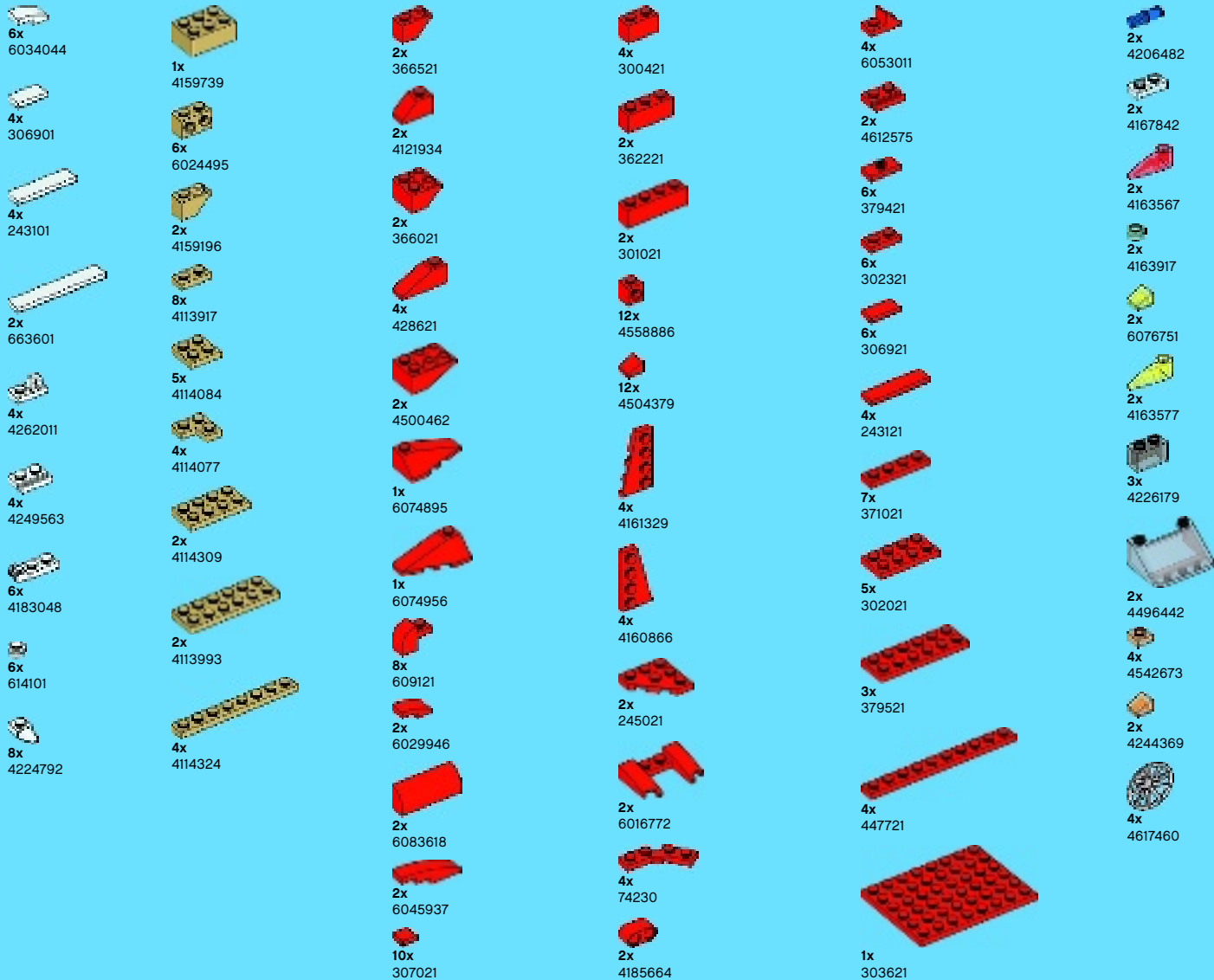

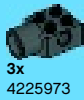

3x  
4225973



2x  
4210725



3x  
4225975



1x  
4210997



2x  
6019987



1x  
4210660



2x  
4210883



2x  
6015356



4x  
6083620



2x  
4632571



2x  
6020193



2x  
4225201



8x  
4211440



2x  
4654582



4x  
4535738



2x  
4515369



4x  
4211573



2x  
4211705



4x  
4114689



8x  
614126



4x  
4278359



2x  
4227684



4x  
4517737



4x  
4550937



1x  
6057397



2x  
4541191



1x  
4289538



4x  
4121715



2x  
428226



3x  
4213374



4x  
654126



2x  
366526



4x  
241226



10x  
362326



7x  
302126



2x  
371026



3x  
302026



8x  
366626

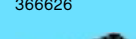

5x  
379526



1x  
447726



Customer Service

Kundenservice

Service Consommateurs

Servicio Al Consumidor

LEGO.com/service or dial



00800 5346 5555 :



1-800-422-5346 :





# club™

## Free\*! Gratuit !

\* Paid subscription in Australia and New Zealand.  
Abonnement payant en Australie et Nouvelle-Zélande.



[LEGO.com/club](http://LEGO.com/club)

# WIN

GO TO [WWW.LEGO.COM/PRODUCTFEEDBACK](http://WWW.LEGO.COM/PRODUCTFEEDBACK) AND  
GIVE US YOUR SHORT **FEEDBACK** ABOUT THIS  
LEGO® SET FOR A CHANCE TO WIN  
A COOL LEGO PRIZE.



## [LEGO.com/productfeedback](http://LEGO.com/productfeedback)

### GEWINNE



Erzähle uns auf  
[www.LEGO.com/productfeedback](http://www.LEGO.com/productfeedback)

etwas über die Erfahrungen, die du mit  
diesem LEGO® Set gemacht hast, und  
sichere dir die Chance auf einen coolen  
LEGO Preis!

### GAGNE



Rends-toi sur  
[www.LEGO.com/productfeedback](http://www.LEGO.com/productfeedback)

et donne-nous quelques commentaires  
sur ce produit LEGO® pour avoir une  
chance de gagner un prix LEGO !

### GANAN



Visita  
[www.LEGO.com/productfeedback](http://www.LEGO.com/productfeedback)

y envíanos tu opinión acerca de este set  
LEGO®. ¡Participarás en el sorteo de un  
premio LEGO!

### 获取奖品



登录  
[www.LEGO.com/productfeedback](http://www.LEGO.com/productfeedback)

给出关于此乐高®套装的简短反馈，  
就有机会获得炫酷乐高奖品