



# CREATOR

31003





1x

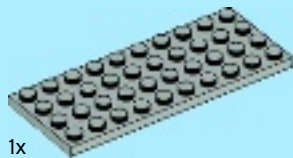

1

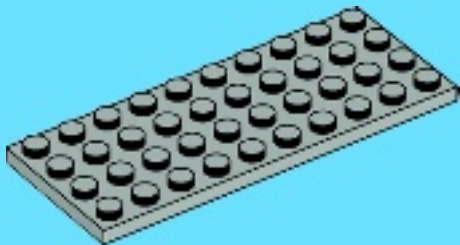

2



2x



1x

2

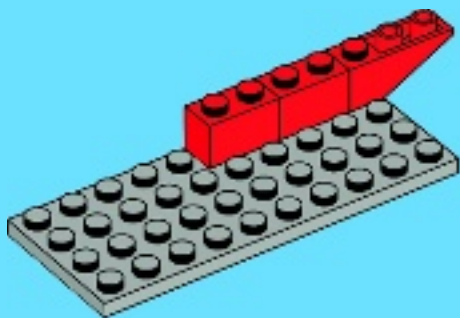



2x



1x

3

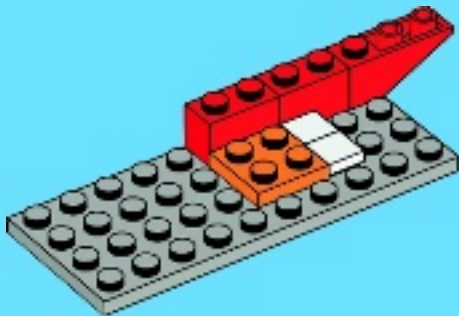

4



1x



1x

1



2



4

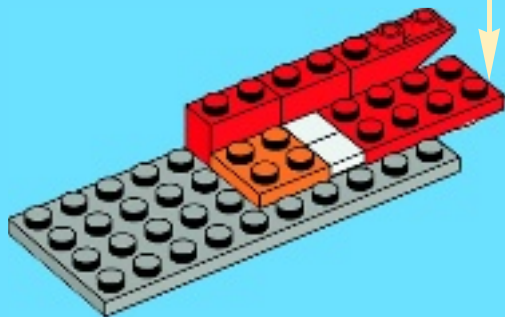

5



2x



1x

5

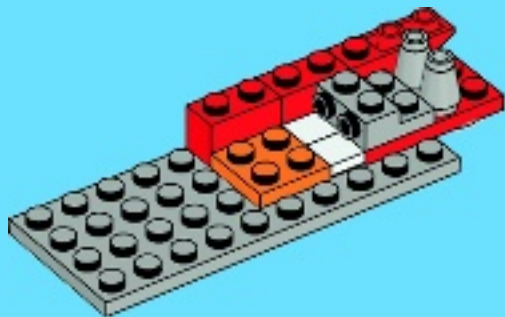

6



1x



2x

6

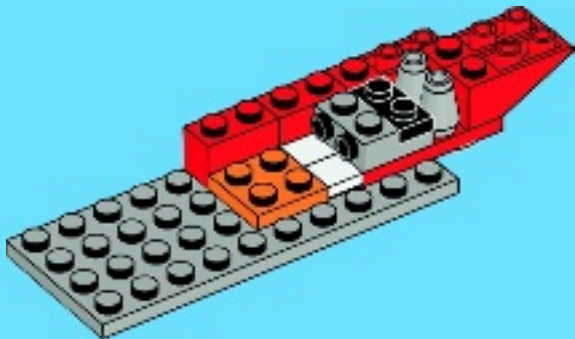



2x



1x

7

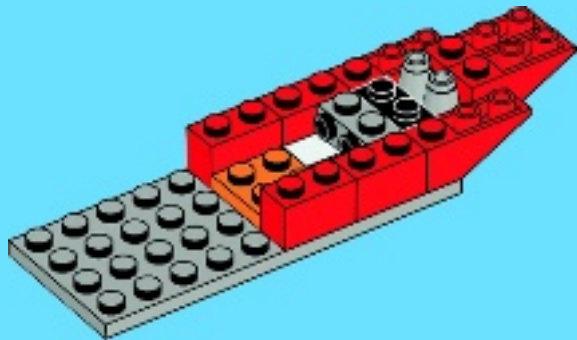

8





1x



2x



2x

8

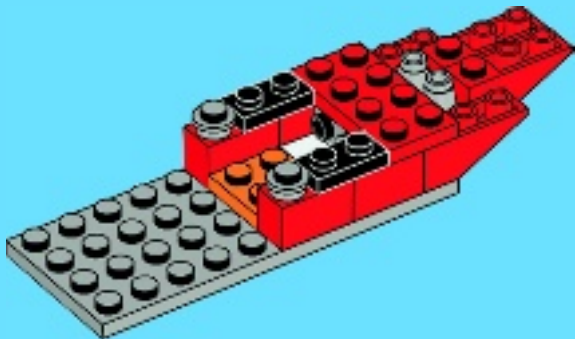



2x



2x

9

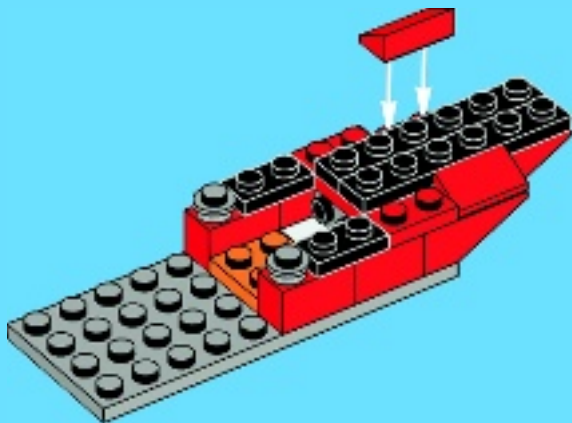



1x



2x

10

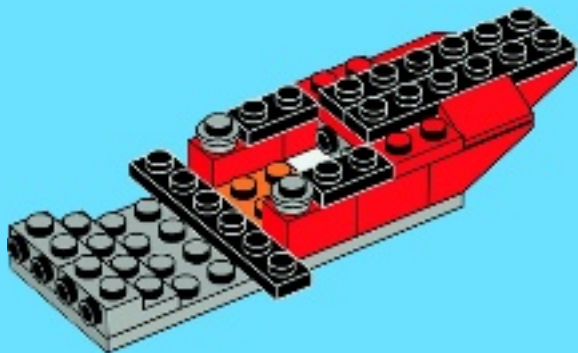



1x

1



12



1x

2





1x

3

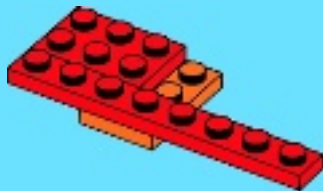



1x

4

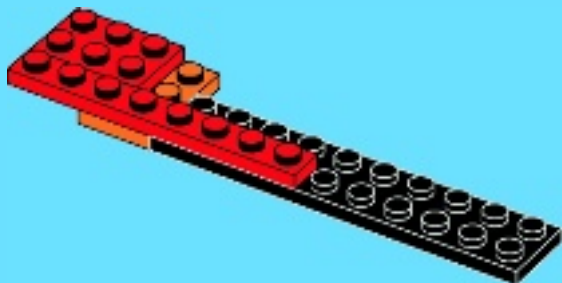



1x



2x

5

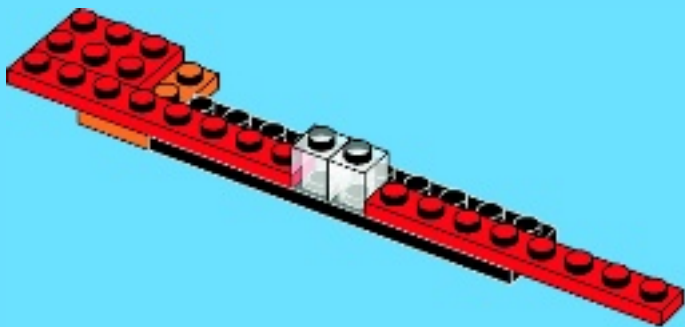



1x

6

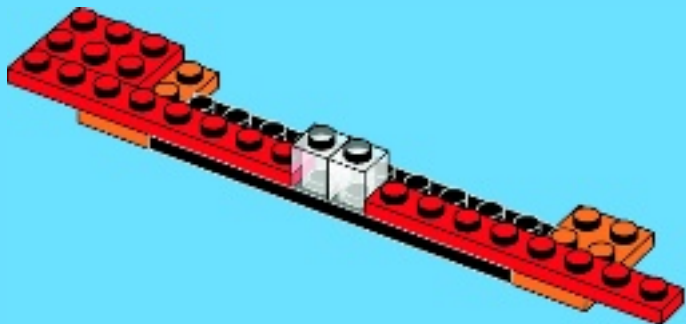





1x

7

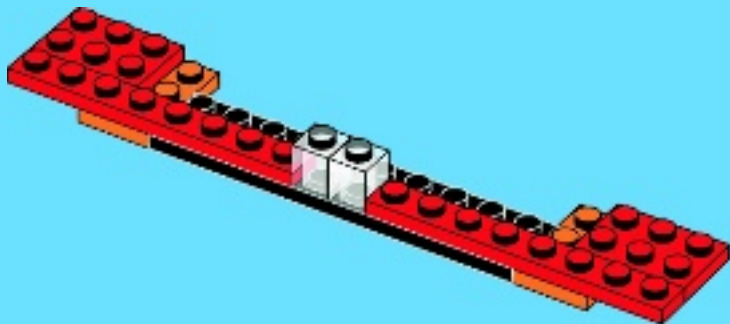



2x

8

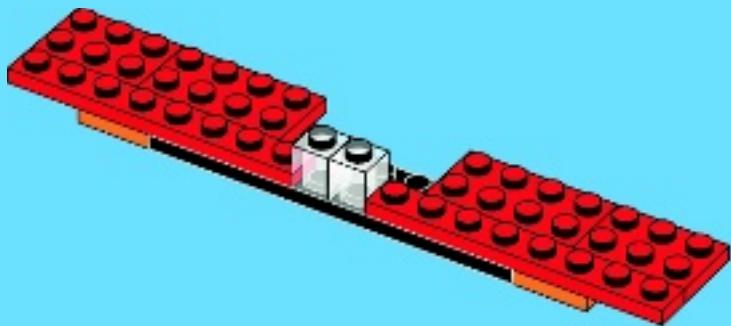



2x



2x

9

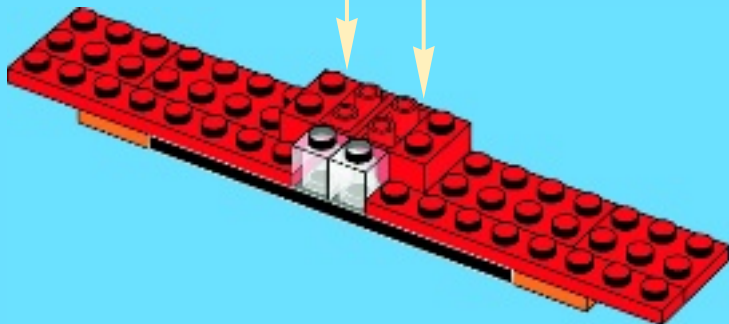



2x



1x

10

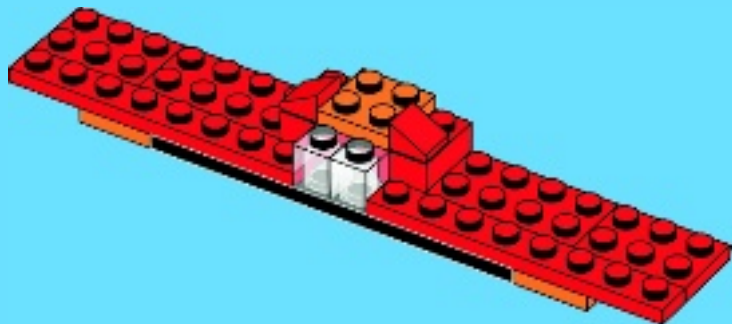

20



2x

11

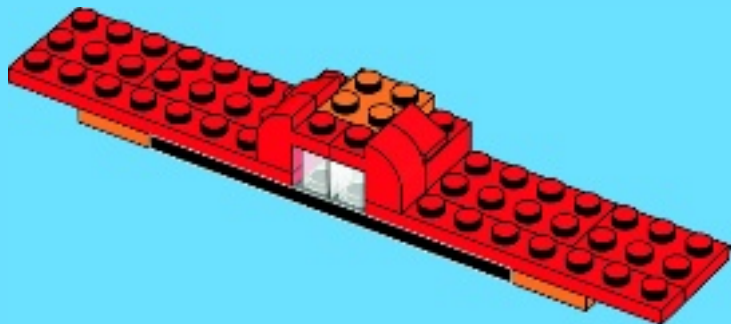



2x



2x



2x

12

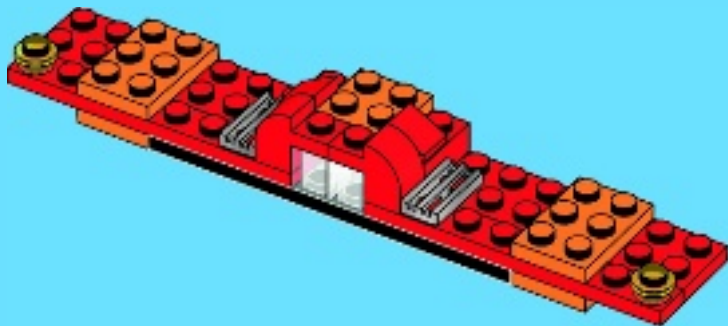

13

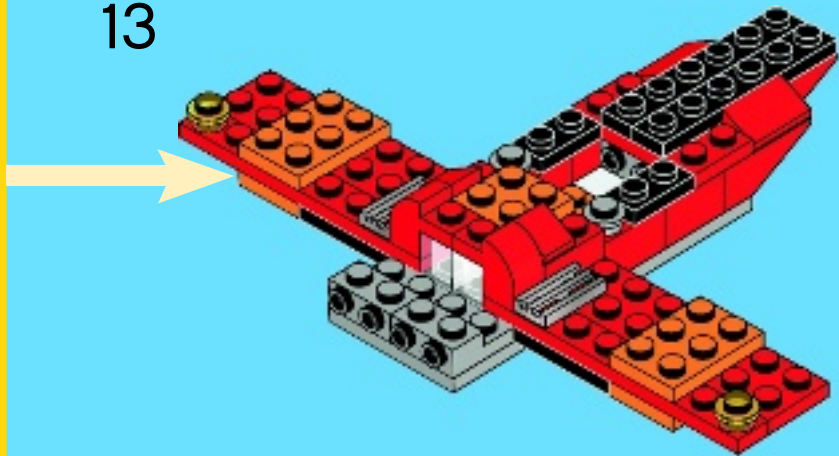



2x

14

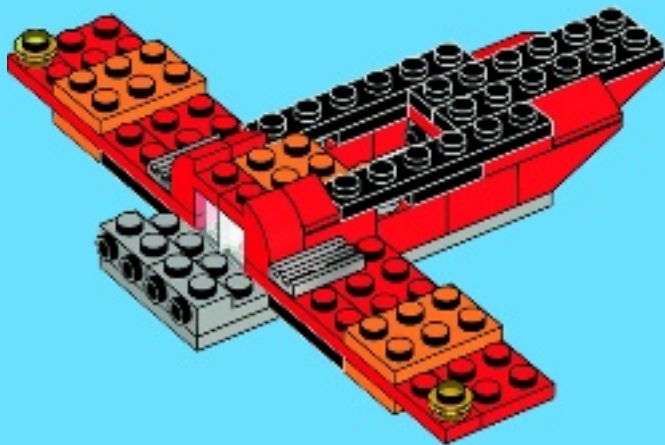

24





2x



2x



1x

15

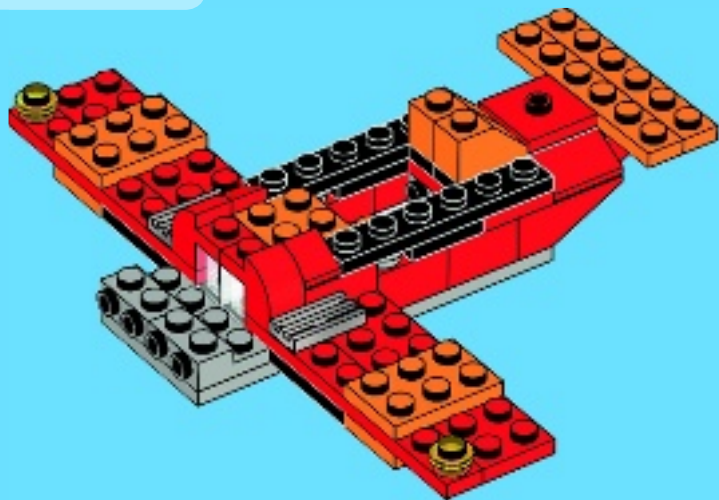



1x



1x

16

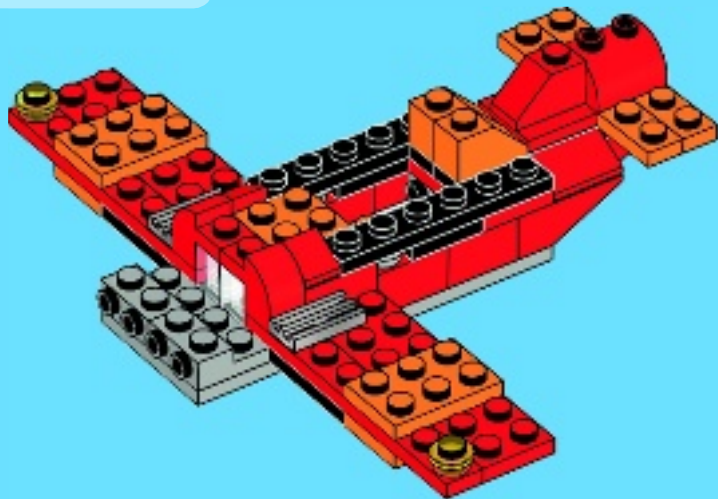



2x



2x

17

1

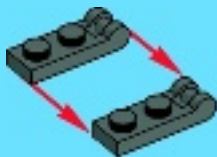

2

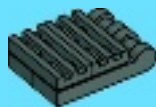

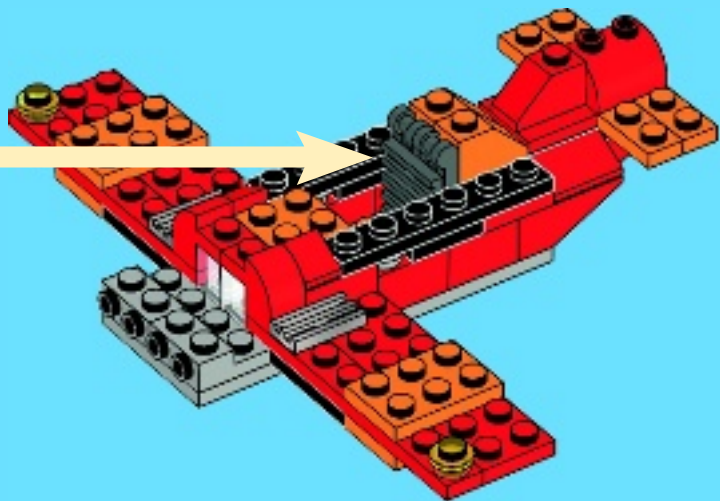



2x



2x

18

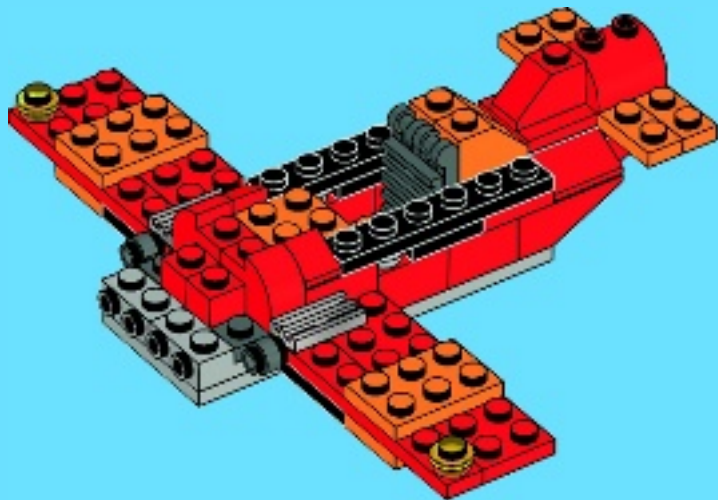



2x



2x

19

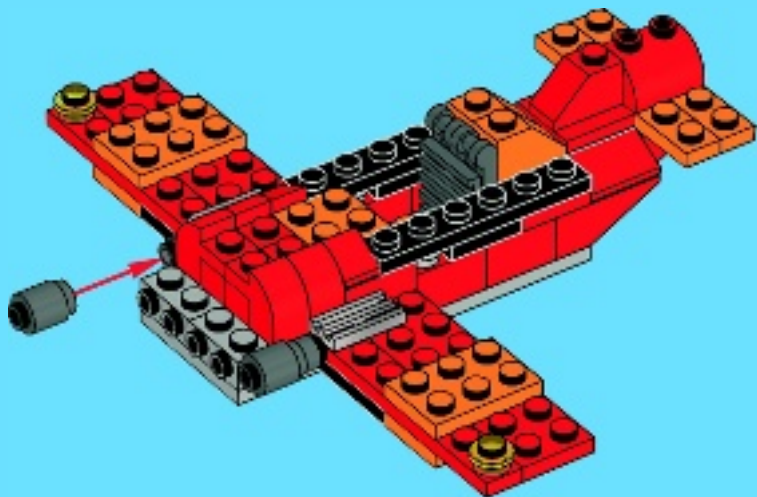

30



1x



1x

20

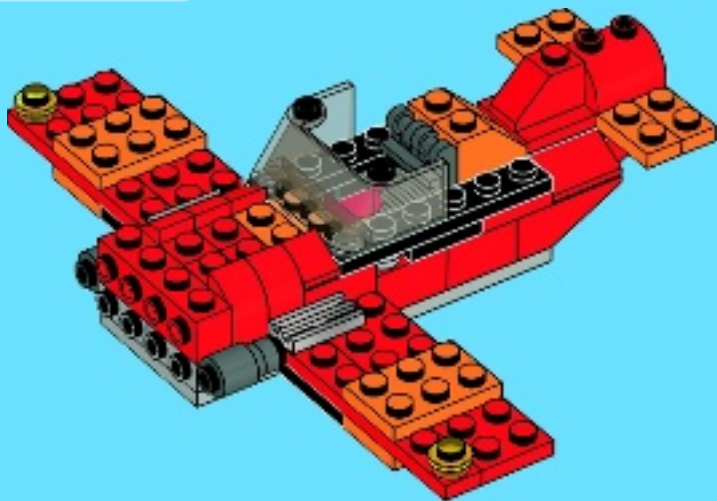



2x

21

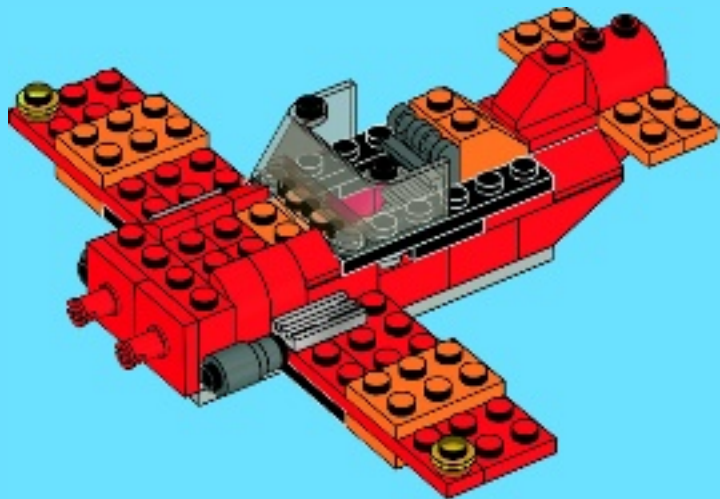





1x



2x

22

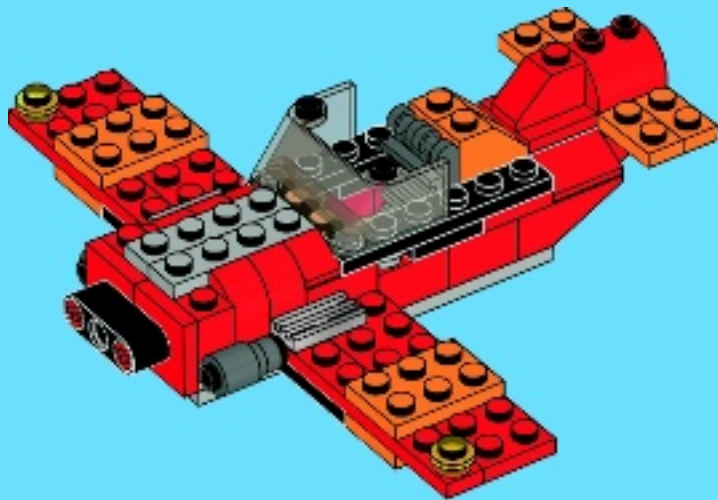



2x



2x



2x



1x

# 23

1

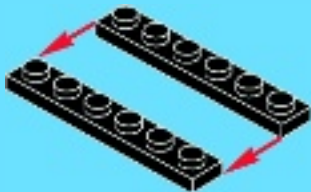

2



3



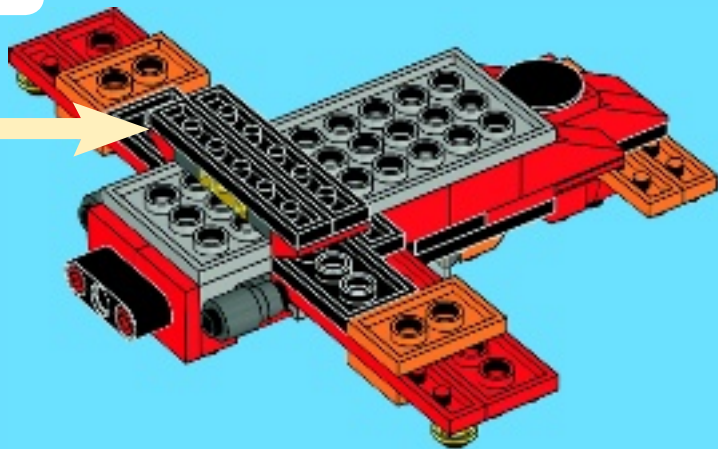



3x



3x



3x

24

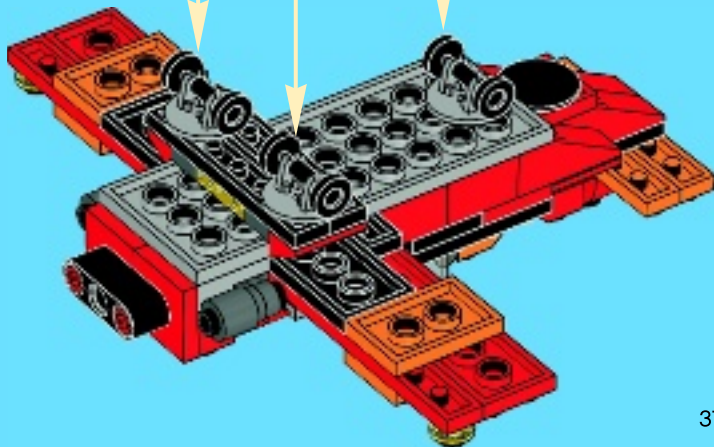



1x



1x



1x



1x

# 25

1



2



3



4



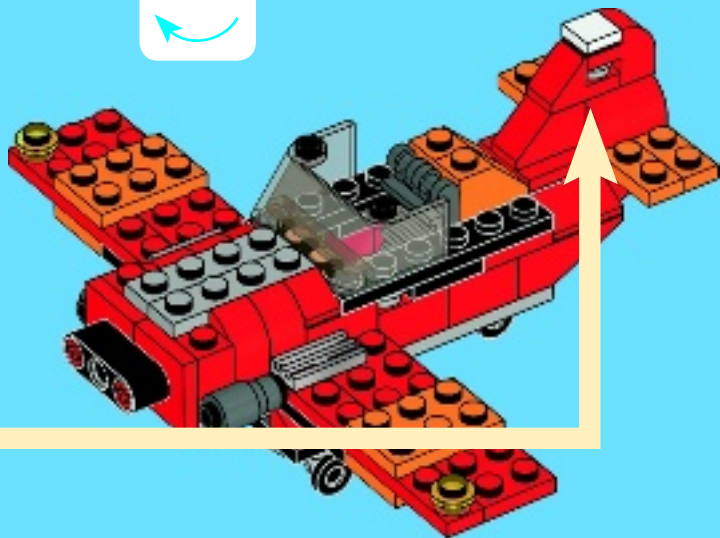



3x



1x



1x



1x

26

1



2

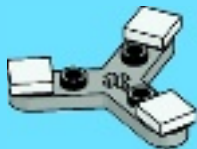



3



4



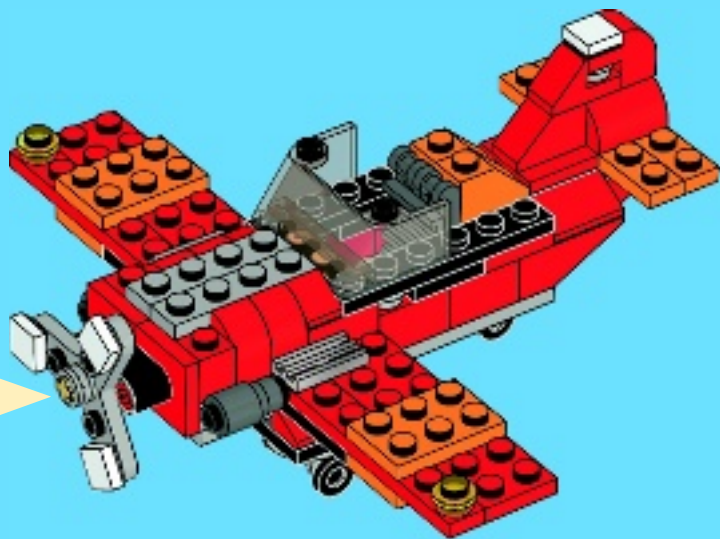



www.LEGOclub.com/Max

**LEGO** club™

**FREE\*! GRATIS! GRATUIT !**

\*Paid subscription in Australia and New Zealand.

\*Abonnement payant en Australie et Nouvelle-Zélande.





# WIN!

Go to [www.LEGOsurvey.com/product](http://www.LEGOsurvey.com/product) to fill out a survey for a chance to win a cool LEGO® Product.

No purchase necessary.

Open to all residents where not prohibited.



## [www.LEGOsurvey.com/product](http://www.LEGOsurvey.com/product)

### GEWINNE!

Nimm an der Umfrage auf [www.LEGOsurvey.com/product](http://www.LEGOsurvey.com/product) teil und hab die Chance ein cooles LEGO® Produkt zu gewinnen! Die Teilnahme am Gewinnspiel führt zu keinerlei Kaufverpflichtungen. Teilnahme in allen nicht ausgeschlossenen Ländern möglich.

### WIN!

Ga naar [www.LEGOsurvey.com/product](http://www.LEGOsurvey.com/product), vul een enquêteformulier in en maak kans op een cool LEGO® product. Geen aankoopverplichting. Iedereen mag deelnemen, uitgezonderd ingezetenden van landen waar een enquêteverbod geldt.

### GAGNE !

Visite [www.LEGOsurvey.com/product](http://www.LEGOsurvey.com/product) pour répondre à un questionnaire et avoir une chance de gagner un produit LEGO® très cool ! Aucune obligation d'achat. Ouvert à tous les résidents des pays autorisés.

### 当てよう!

[www.LEGOsurvey.com/product](http://www.LEGOsurvey.com/product) にアクセスして、アンケートにご記入ください。当選者にはレゴ®製品を差し上げます。お買い上げの必要はありません。禁止されていない限り、すべての皆様にご利用いただけます。



6036024 / 6036025

LEGO and the LEGO logo are trademarks of the/sont des marques de commerce de/son marcas registradas de LEGO Group. ©2013 The LEGO Group.